

LineLED Flex 18 is a small profile, high output LED strip specially designed for installations with horizontal plan bend. Bending sections every 1.30" on center allow the LineLED Flex 18 to fit around tight curves.

Mounting
 LLED strip is equipped with 3M™ adhesive transfer tape (9472LE).

Applications: Indoor only
 - cove lighting, architectural reveals, under banister, general ambient lighting, etc.

Approvals
 Class 2 damp listed

Operating voltage
 24 VDC

Average life
 50,000 hours

Warranty
 5 years



Technical information

MODEL	LLFLEX18
LEDS/ft	18
Light output 3000K	300 lum/ft
Average power consumption (for 15' section)	2.65 W/ft
Ordering increment	4.00"
Maximum run length (in series)	22 ft
Dimensions	0.39" W 0.05" H

PRODUCT DIMENSIONS

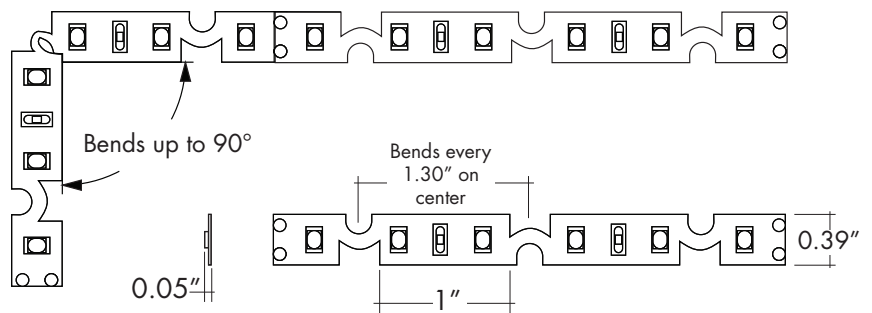

CCT INFO/LUMEN MULTIPLIER		TM-30-15		
Color temperature	Multiplier (referenced from 3000K)	CRI	R _f	R _g
2200K	0.87	82	81	99
2400K	0.73	98	95	101
2700K	0.81	98	95	102
3000K	1.00	91	90	101
3500K	1.05	95	90	97
4100K	1.28	93	88	96

SECTION START/END OPTIONS

NC - No connector



LF - Power Feed lead Female 3" cable

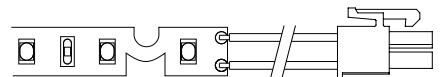

SL - Soldered lead wire (72")



MF - Power Feed lead Male 3" cable

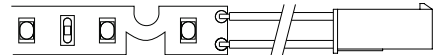

Ordering code

MODEL	COLOR TEMPERATURE	SECTION START	SECTION END	LENGTH
LLFLEX18	22K	SL	SL	4
LLFLEX18	22K - 2200K 24K - 2400K 27K - 2700K 30K - 3000K 35K - 3500K 41K - 4100K	SL - Soldered lead wires (72") LF - Lead female MF - Lead male NC - No connector	SL - Soldered lead wires (72") LF - Lead female MF - Lead male NC - No connector	4" increments - up to 22'

Power consumption per linear foot

loads tested with PSD series of power supplies (page 4)

POWER CONSUMPTION PER FOOT

Length of strip (LF)	W/ft	Total wattage
1	3.35	3.35
2	3.35	6.70
3	3.30	9.90
4	3.25	13.00
5	3.20	16.00
6	3.15	18.90
7	3.10	21.70
8	3.05	24.40
9	3.00	27.00
10	2.95	29.50
11	2.90	31.90
12	2.80	33.60
13	2.75	35.75
14	2.70	37.80
15	2.65	39.75
16	2.60	41.60
17	2.55	43.35
18	2.50	45.00
19	2.45	46.55
20	2.40	48.00
21	2.35	49.35
22	2.30	50.60

Accessories

Part # CL-1

Mounting clip:
recommended at every 12" when
LineLED strip is facing down.

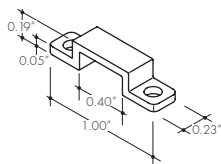

Part # LVSP-4T-BK

Splice Box:
low voltage, 4 terminal splice box, black.

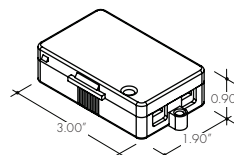

Part # LL.ZIP

Strain Relief Clip

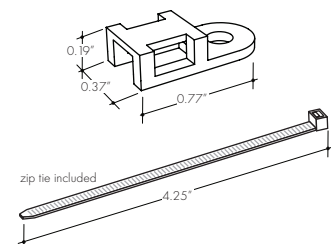

Lens options / light transmission percentage per lens

- C** Clear
- HF** Half (50%) Frosted
- G** Graze
- SI** Satin Ice
- S** Square Frosted
- Q** Rounded Square Frosted
- F** Frosted
- M** Medium beam frosted
- R** Raised
- C36** Clear 36° beam angle
- C10** Clear 10° beam angle

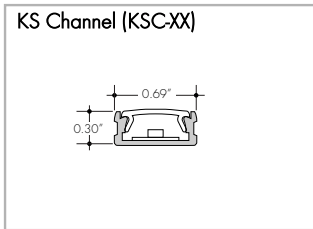

- C** 85%
- F** 55%
- HF** 72%
- C36** 83%
- R** 51%

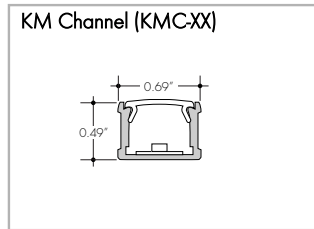

- C** 71%
- F** 42%
- HF** 58%
- C10** 67%
- R** 39%

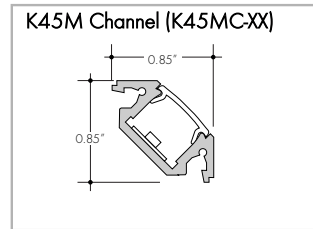

- C** 71%
- F** 42%
- HF** 58%
- C10** 67%

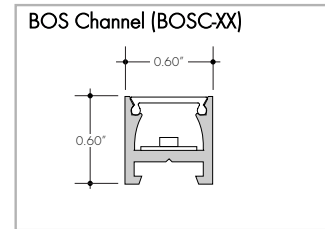

- F** 43%
- SI** 56%
- R** 46%
- G** 67%

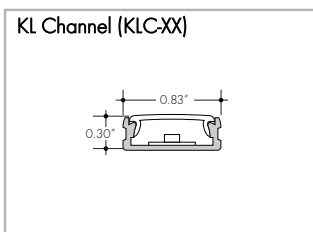

- C** 83%
- F** 55%
- HF** 68%

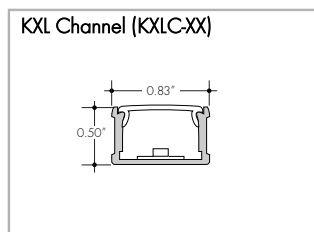

- C** 74%
- F** 46%
- HF** 61%

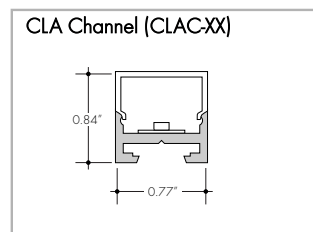

- S** 62%
- Q** 63%

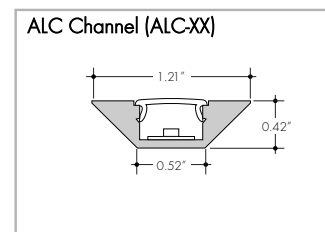

- C** 79%
- F** 58%
- HF** 69%

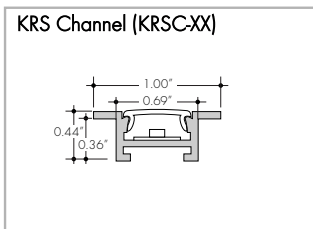

- C** 85%
- F** 55%
- HF** 72%

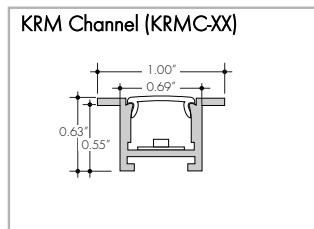

- C** 71%
- F** 42%
- HF** 58%

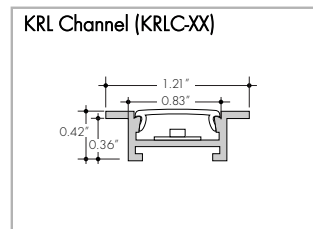

- C** 83%
- F** 55%
- HF** 68%

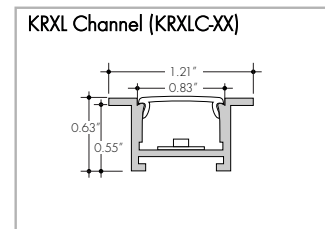

- C** 74%
- F** 46%
- HF** 61%

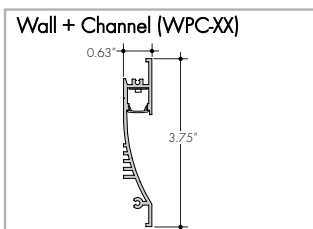

- C** 47%
- F** 44%

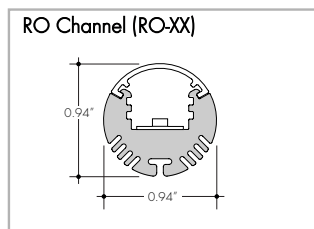

- C** 75%
- F** 52%

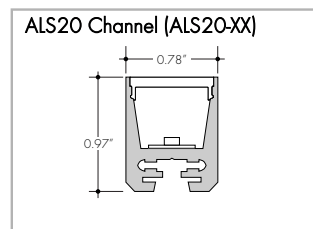

- C** 78%
- F** 43%

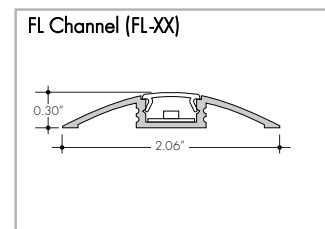

- C** 85%
- F** 63%
- HF** 75%

Installation

All mounting channels are field cuttable using miter saw with circular blade suitable for cutting aluminum.

Ordering

Extrusions are sold separately. View respective specsheets for details on ordering extrusions and their accessories (endcaps, mounting brackets, etc).

Discontinued Extrusion Reference Link

<https://www.luminii.com/media/4351/extrusion-update.pdf>

LED Dotting per extrusion

using the frosted lens option

extrusion	LL18
KSC, KRSC, FL, ALC	CD
KMC, KRMC, K45MC	SD
KXLC, KRXLC	CD
KL, KRLC	CD
WPC	CD
RO, ALS20	SD
BOSC	CD
CLAC	SD



Clear Dotting (CD) Slight Dotting (SD) NO Dotting (ND)

Power supply

See fixture and power supply instructions & spec sheet for wiring information. Dimming possible in select models - view Luminii website for list of compatible dimmers.

Magnetic Low Voltage Dimming Power Supplies:

MODEL	POWER	OUTPUT	INPUT
PSD	48	24	
PSD - PSD Series dims down to 0%	48 - 48 W 96 - 96 W 288 - 288 W (3x 96W)	24 - 24 VDC	Blank - 120 V 240 - 240 V 277 - 277 V

MODELS	PSD 48	PSD 96	PSD 288
A Length	11.25"	11.25"	13.06"
B Width	3.42"	3.42"	8.42"
C Depth	3.42"	3.27"	4.47"

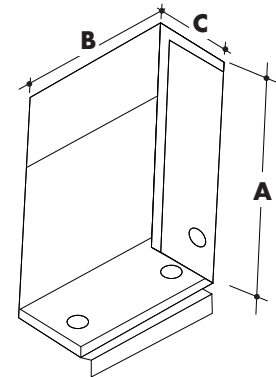

Electronic Low Voltage Dimming Power Supplies:

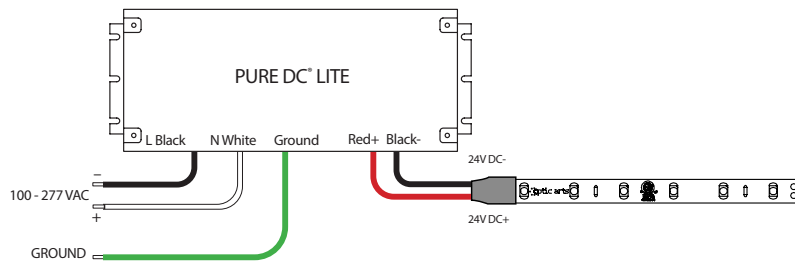

PURE DC® LITE (PDCL)

PART	DESCRIPTION
PDCL30.24	30W 100-277VAC DIMMABLE DRIVER
PDCL60.24	60W 100-277VAC DIMMABLE DRIVER
PDCL96.24	96W 100-277VAC DIMMABLE DRIVER

DIMENSIONS

PART	H 1.03"; W 6.50"; D 3.62"
PDCL30.24	H 1.03"; W 6.50"; D 3.62"
PDCL60.24	H 1.03"; W 7.40"; D 3.62"
PDCL96.24	H 1.61"; W 8.66"; D 3.66"

DIMMING PERFORMANCE

PURE DC® LITE DRIVER Dims to 1% on most MLV dimmers
NOTE: Must be loaded at least 10% of rated load to obtain optimal dimming.

0-10V Dimming Power Supplies:

MODEL	POWER	OUTPUT	DIMMING
PSO10V	3X96	24	LIN
PSO10V - 0-10V Power Supply dims down to 0%	96 - 96 WATT 3X96 - 3 X 96 WATT	24 - 24 VDC	LIN - Linear LOG - Logarithmic

MODELS	96 W	3X96
A Length	14.40"	15.75"
B Width	5.20"	6.60"
C Depth	2.60"	4.80"

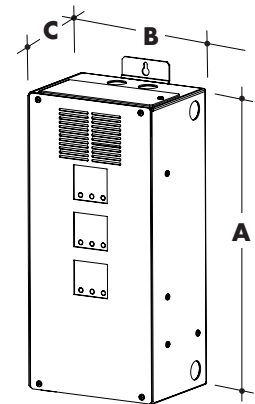

MODEL	POWER	OUTPUT	DIMMING	LOCATION
PSV	40	24	U2DIM	D
PSV - PSV Series dims down to 5%	40 - 40 W 60 - 60 W 96 - 96 W	24 - 24 VDC	U2DIM - Dimming 0-10V	D - Dry Location IP65 - Wet Location

MODELS	PSV Dry	PSV Wet
A Length	9.2"	9.5"
B Width	3.4"	4.12"
C Depth	1.9"	2.3"

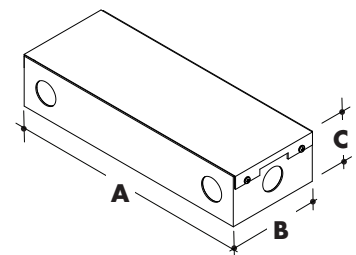

Power supply

See fixture and power supply instructions & spec sheet for wiring information. Dimming possible in select models - view Luminii website for list of compatible dimmers.

DMX Dimming Power Supplies:

MODEL	POWER	OUTPUT
PSDMX	96	24
PSDMX - DMX Power Supply	96 - 96 WATT 3X96 - 3 X 96 WATT	24 - 24 VDC

- Features eldoLED's LINEARdrive configurable dimmable drivers

MODELS	3X96 W
A Length	15.75"
B Width	6.60"
C Depth	4.80"

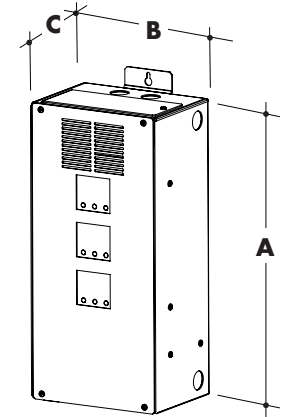

DALI Dimming Power Supplies:

MODEL	POWER	OUTPUT
PSDALI	96	24
PSDALI - DALI Power Supply dims down to 0%	96 - 96 WATT 3X96 - 3 X 96 WATT	24 - 24 VDC

- Features eldoLED's LINEARdrive configurable dimmable drivers

MODELS	96 W
A Length	14.40"
B Width	5.20"
C Depth	2.60"

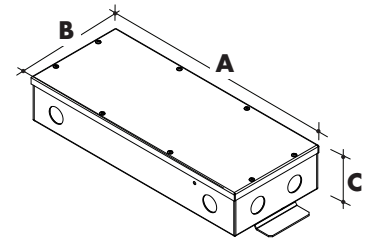

LUTRON®

Luminii is a Lutron OEM Advantage Partner

MODEL		
LTEA4U1UKL-CV240		
Lutron -Hi-lume™ 1% 2-wire LED driver (120V forward phase only)		

MODELS	LTEA	L3DA
A Length	4.89"	4.89"
B Width	2.66"	2.66"
C Depth	4.00"	4.00"

MODEL		
L3DA4U1UKL-CV240		
Hi-lume™ 1% EcoSystem Voltage LED Driver		

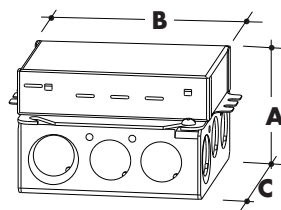

MODEL		
L3DO-96W24V-U		
Hi-lume™ 0.1% EcoSystem Voltage LED Driver with Soft-On, Fade-to-Black™		

MODELS	L3DO
A Length	10.50"
B Width	5.50"
C Depth	2.00"

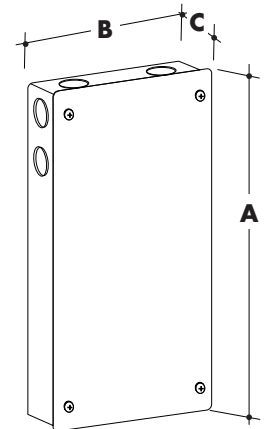

Power supply

See fixture and power supply instructions & spec sheet for wiring information. Dimming possible in select models - view Luminii website for list of compatible dimmers.

Enlighted Enabled Dimming Power Supplies:

MODEL	POWER	OUTPUT	DIMMING	Location
PSV	96	24	ENL	D
PSV - LED Power Supply	96 - 96 WATT	24 - 24 VDC	ENL - Enlighted Dimming	D - Damp

MODELS	96 W
A Length	14.40"
B Width	5.20"
C Depth	2.60"

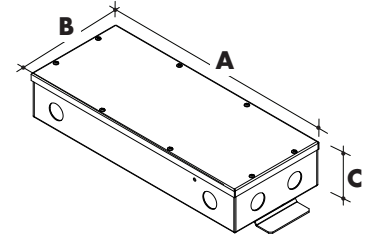

Non-Dimming Power Supplies:

MODEL	POWER	OUTPUT	DIMMING	LOCATION
PSV	40	24V	U2ND	D
PSV - PSV Series	40 - 40 W 60 - 60 W 96 - 96 W	24 - 24 VDC	U2ND - Non Dimming	D - Dry Location IP65 - Wet Location

MODELS	PSV Dry	PSV Wet
A Length	9.2"	9.5"
B Width	3.4"	4.12"
C Depth	1.9"	2.3"

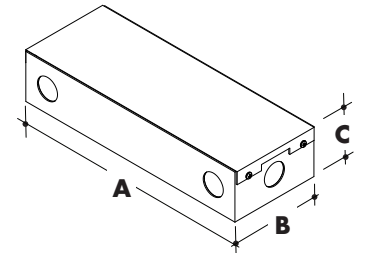

In ground, Electronic Low Voltage Dimming Power Supplies:

MODEL	CIRCUIT x POWER	OUTPUT	INPUT
IG-CVE	96X2	24	
IG-CVE - In ground CVE Series dims down to 0.1%	96X2 - 2 x 96W	24 - 24 VDC	Blank - 120 V 277 - 240/277 V

MODELS	Dual circuit
A Length	8.0"
B Width	8.0"
C Depth	8.0"

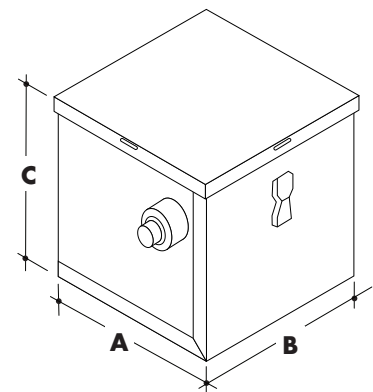

TM-30-15: Data

22K CCT

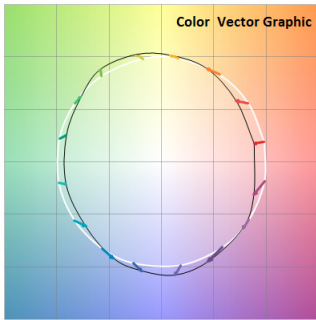

Hue Bin	R_f	Graphic shifts (%)	
		Chroma	Hue
1	79	-10%	0%
2	79	-8%	8%
3	70	-2%	14%
4	85	2%	8%
5	90	5%	5%
6	90	6%	-3%
7	84	-2%	-8%
8	89	-6%	-4%
9	85	-6%	3%
10	78	-6%	11%
11	77	2%	14%
12	79	6%	9%
13	88	8%	-7%
14	67	4%	-20%
15	84	0%	-10%
16	75	-7%	-14%

24K CCT

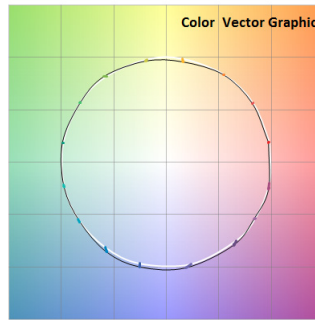

Hue Bin	R_f	Graphic shifts (%)	
		Chroma	Hue
1	97	-1%	0%
2	97	-1%	0%
3	97	0%	1%
4	95	-3%	-1%
5	96	-1%	2%
6	96	1%	3%
7	97	0%	1%
8	98	1%	0%
9	97	0%	2%
10	95	0%	3%
11	93	3%	4%
12	93	3%	1%
13	93	3%	-6%
14	92	2%	-4%
15	95	-1%	-1%
16	91	0%	-6%

27K CCT

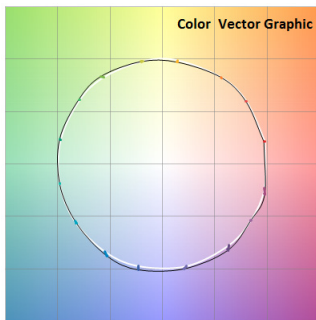

Hue Bin	R_f	Graphic shifts (%)	
		Chroma	Hue
1	97	-1%	0%
2	98	0%	0%
3	96	0%	1%
4	96	-2%	0%
5	96	0%	2%
6	95	2%	2%
7	96	1%	0%
8	98	1%	-1%
9	98	0%	1%
10	95	0%	3%
11	92	2%	5%
12	93	3%	1%
13	95	2%	-3%
14	93	3%	-3%
15	96	0%	-1%
16	91	1%	-6%

30K CCT

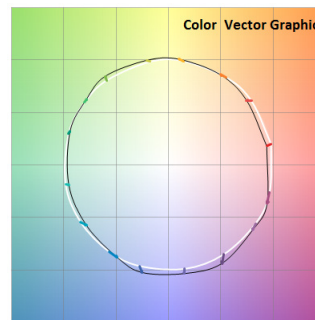

Hue Bin	R_f	Graphic shifts (%)	
		Chroma	Hue
1	90	-4%	-1%
2	91	-4%	3%
3	86	-1%	7%
4	91	1%	5%
5	92	2%	3%
6	93	4%	-1%
7	92	0%	-4%
8	95	-1%	-2%
9	94	-3%	1%
10	87	-3%	6%
11	84	0%	10%
12	88	6%	4%
13	92	4%	-1%
14	88	6%	-6%
15	89	1%	-7%
16	85	0%	-11%

35K CCT

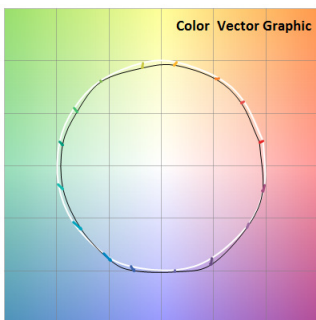

Hue Bin	R_f	Graphic shifts (%)	
		Chroma	Hue
1	91	-4%	0%
2	93	-3%	0%
3	92	-2%	2%
4	92	-3%	1%
5	91	-5%	1%
6	96	-1%	1%
7	92	-4%	1%
8	93	-3%	2%
9	90	-4%	5%
10	83	-3%	10%
11	83	2%	10%
12	89	3%	4%
13	95	2%	-1%
14	90	5%	-4%
15	90	1%	-5%
16	88	0%	-6%

41K CCT

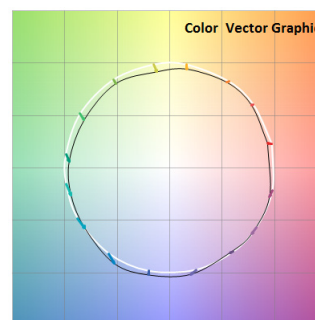

Hue Bin	R_f	Graphic shifts (%)	
		Chroma	Hue
1	88	-4%	1%
2	93	-2%	1%
3	93	-2%	1%
4	89	-4%	-2%
5	88	-7%	-1%
6	93	-4%	0%
7	88	-7%	3%
8	87	-4%	6%
9	82	-3%	12%
10	79	0%	12%
11	83	5%	9%
12	91	4%	0%
13	89	3%	-6%
14	92	-1%	-3%
15	84	0%	-7%
16	84	-1%	-6%