

Extruded aluminum linear illumination system, Zoom is available in sections up to 116" long. Sections can be interconnected to reach 16 feet using the high output LEDs. The small profile of the Zoom light fixture is ideal for applications with limited space requirements like architectural accents, under or above cabinets, display cases, and many more. Approved for closet/storage space installation per NEC 410.16(A)(3) and 410.16(C)(5). Class 2 listed for damp locations. 5 year warranty.

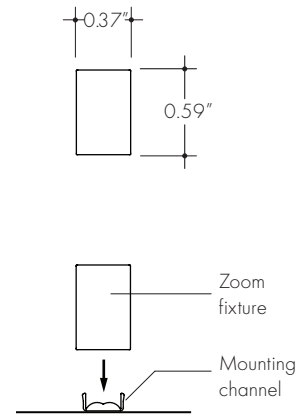

IC RATED

RoHS Compliant

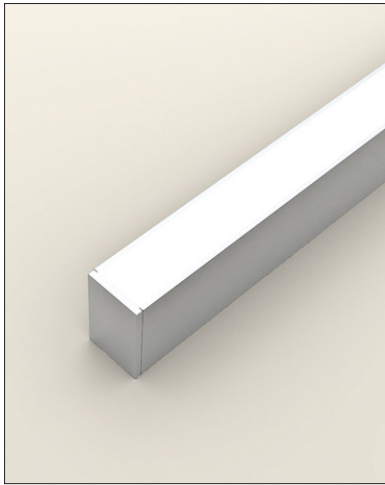

Finish options



Technical information

Output Options	
Output type	HO (LL36-5MM)
Lumens at 3000K (Clear lens)	122 lm/ft
Average power consumption at 4'	3.2 W/ft
Maximum system length <i>Achievable via feed through fixture wiring.</i>	16'
Operating Voltage	24VDC

CCT INFO/LUMEN MULTIPLIER		TM-30-15		
Color temperature	Multiplier (referenced from 3000K)	CRI	R _f	R _g
2200K	0.87	82	81	99
2400K	0.73	98	95	101
2700K	0.81	98	95	102
2900K	0.86	97	95	102
3000K	1.00	91	90	101
3500K	1.05	95	90	97
4100K	1.28	93	88	96

Ordering code

MODEL	LENGTH	CCT	OUTPUT	OPTIC	FINISH	POWER FEED
ZO	24	22K	HO	C	SA	F1
ZO - Zoom	12" - 116" 4" increments	22K - 2200 K 24K - 2400 K 27K - 2700 K 29K - 2900 K 30K - 3000 K 35K - 3500 K 41K - 4100 K	HO - High	C - Clear F - Frosted	SA - Silver BK - Black BZ - Bronze WH - White <small>(BK, BZ, WH finishes will have an upcharge and require longer lead times)</small>	F1 - 72" wire leads F1X2 - 72" wire lead at both ends F2 - 72" wire leads at one end and quick connect at the other F3 - Single quick connect F4 - Dual quick connect F5 - 72" wire back feed

Photometry

ZO-48-30K-HO-C-XX

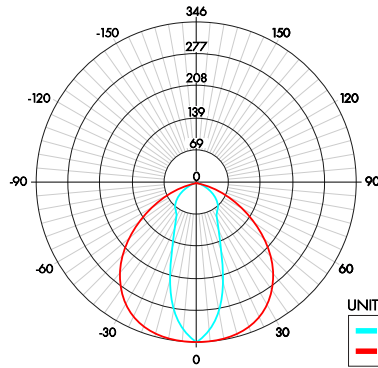

Zonal Lumen Summary 3000K

Zone	Lumen	% Fixture
0-30	202	41%
0-40	292	59%
0-60	430	88%
0-90	484	99%
0-180	487	100%

Total

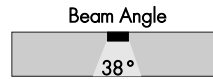

UNIT: CD
 — C0/180
 — C90/270

Power consumption per fixture length

Based on operation with PSD series of power supplies.

HO (L136-5MM)			
Nominal length	*Actual length	W/ft	Total wattage
12	13 "	3.25	3.25
16	16-14/16"	3.25	4.00
20	20-14/16"	3.25	5.25
24	24-12/16"	3.25	6.50
28	28-11/16"	3.25	7.75
32	32-11/16"	3.25	8.50
36	36-9/16"	3.25	9.75
40	40-8/16"	3.25	10.25
44	44-8/16"	3.20	11.75
48	48-7/16"	3.20	12.80
52	52-6/16"	3.20	13.30
56	56-5/16"	3.20	14.80
60	60-4/16"	3.20	16.00
64	64-3/16"	3.20	17.00
68	70-1/16"	3.15	18.00
72	74 "	3.15	18.90
76	77-15/16"	3.15	19.00
80	81-15/16"	3.15	21.50
84	85-13/16"	3.15	22.05
88	89-12/16"	3.15	23.00
92	93-11/16"	3.10	24.00
96	97-10/16"	3.10	24.80
100	101-10/16"	3.10	26.30
104	105-8/16"	3.05	27.10
108	109-8/16"	3.05	28.00
112	113-7/16"	3.05	28.50
116	117-5/16"	3.05	30.00

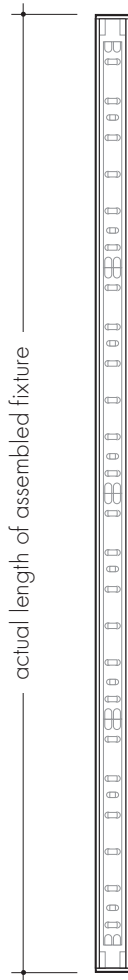

Connectors & Accessories

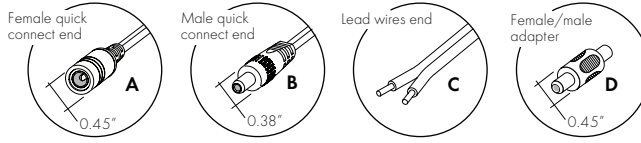

Linking and extension cable options

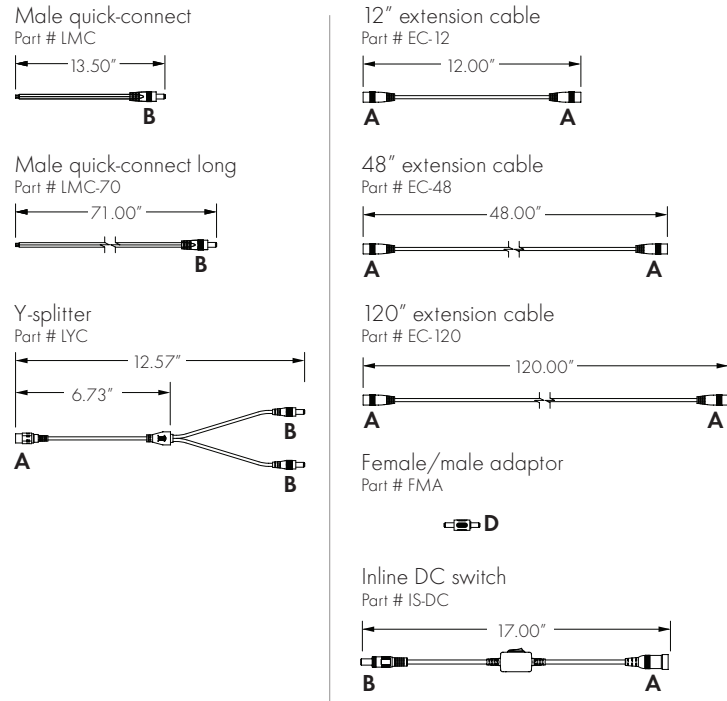

Powerfeed options

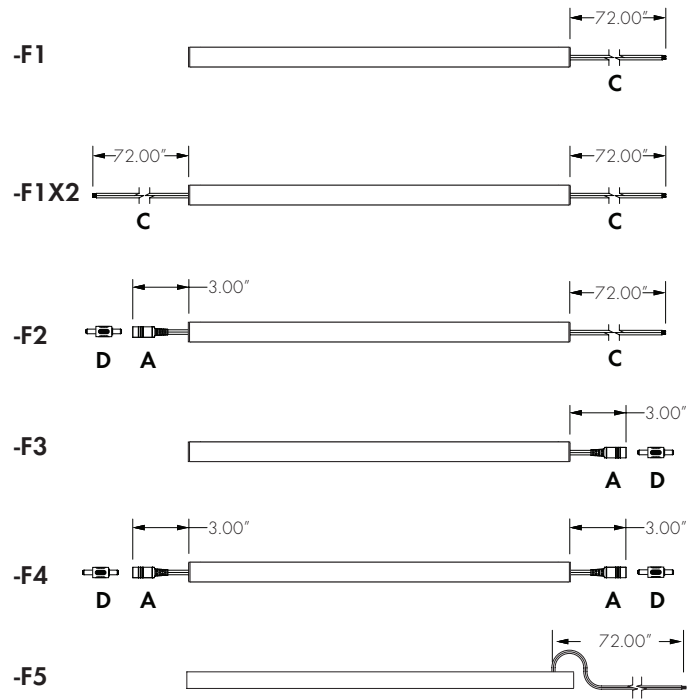

Accessories

Splice Box:
Low voltage, 4 terminal splice box, black.

Part # LVSP-4T-BK

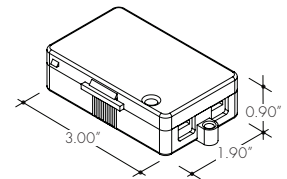

Sample layout of powerfeed connections

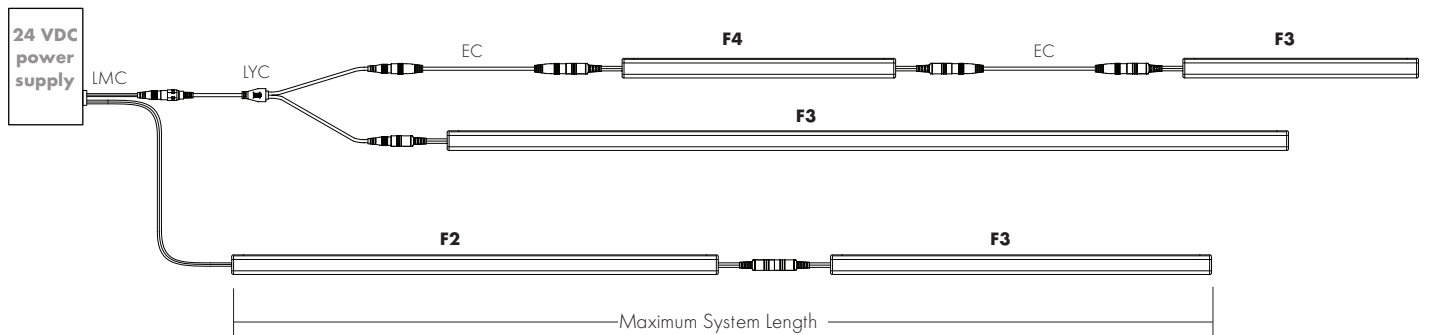

Power supply

See fixture and power supply instructions & spec sheet for wiring information. Dimming possible in select models - view Luminii website for list of compatible dimmers.

Magnetic Low Voltage Dimming Power Supplies:

MODEL	POWER	OUTPUT	INPUT
PSD	48	24	
PSD - PSD Series dims down to 0%	48 - 48 W 96 - 96 W 288 - 288 W (3x 96W)	24 - 24 VDC	Blank - 120 V 240 - 240 V 277 - 277 V

MODELS	PSD 48	PSD 96	PSD 288
A Length	11.25"	11.25"	13.06"
B Width	3.42"	3.42"	8.42"
C Depth	3.42"	3.27"	4.47"

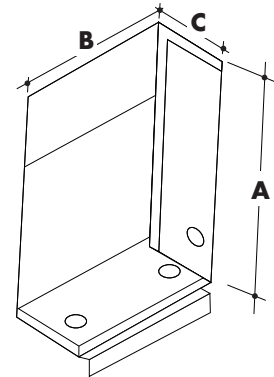

Electronic Low Voltage Dimming Power Supplies:

MODEL	CIRCUIT x POWER	OUTPUT	INPUT
CVE	48D	24	
CVE - CVE Series dims down to 0.1%	48D - 48W 48X2D - 2 x 48W 48X3D - 3 x 48W 48X4D - 4 x 48W 96D - 96W 96X2D - 2 x 96W 96X3D - 3 x 96W 96X4D - 4 x 96W	24 - 24 VDC	Blank - 120 V 277 - 240/277 V

MODELS	Single circuit	Dual circuit	Three circuit	Four circuit
A Length	13.9"	13.8"	13.8"	13.8"
B Width	2.3"	4.0"	5.9"	7.75"
C Depth	1.3"	1.9"	1.9"	1.9"

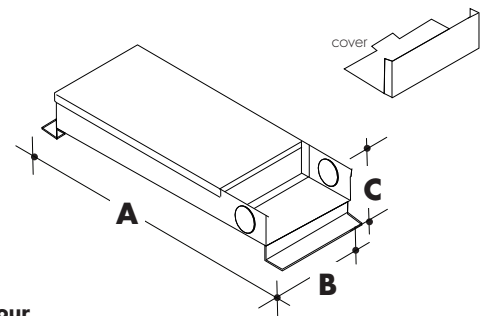

0-10V Dimming Power Supplies:

MODEL	POWER	OUTPUT	DIMMING
PSO10V	3X96	24	LIN
PSO10V - 0-10V Power Supply dims down to 0%	96 - 96 WATT 3X96 - 3 X 96 WATT	24 - 24 VDC	LIN - Linear LOG - Logarithmic

MODELS	96 W	3X96
A Length	14.40"	15.75"
B Width	5.20"	6.60"
C Depth	2.60"	4.80"

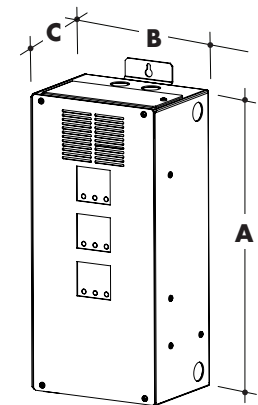

MODEL	POWER	OUTPUT	DIMMING	LOCATION
PSV	40	24	U2DIM	D
PSV - PSV Series dims down to 5%	40 - 40 W 60 - 60 W 96 - 96 W	24 - 24 VDC	U2DIM - Dimming 0-10V	D - Dry Location IP65 - Wet Location

MODELS	PSV Dry	PSV Wet
A Length	9.2"	9.5"
B Width	3.4"	4.12"
C Depth	1.9"	2.3"

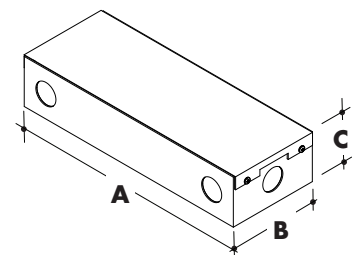

Power supply

See fixture and power supply instructions & spec sheet for wiring information. Dimming possible in select models - view Luminii website for list of compatible dimmers.

DMX Dimming Power Supplies:

MODEL	POWER	OUTPUT
PSDMX	96	24
PSDMX - DMX Power Supply	96 - 96 WATT 3X96 - 3 X 96 WATT	24 - 24 VDC

- Features eldoLED's LINEARdrive configurable dimmable drivers

MODELS 3X96 W

A Length	15.75"
B Width	6.60"
C Depth	4.80"

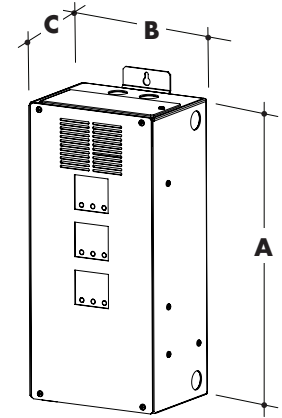

DALI Dimming Power Supplies:

MODEL	POWER	OUTPUT
PSDALI	96	24
PSDALI - DALI Power Supply dims down to 0%	96 - 96 WATT 3X96 - 3 X 96 WATT	24 - 24 VDC

- Features eldoLED's LINEARdrive configurable dimmable drivers

MODELS 96 W

A Length	14.40"
B Width	5.20"
C Depth	2.60"

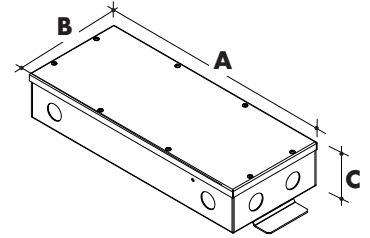

LUTRON®

Luminii is a Lutron OEM Advantage Partner

MODEL

LTEA4U1UKL-CV240

Lutron -Hi-lume™ 1% 2-wire
LED driver (120V forward phase only)

MODELS	LTEA	L3DA
A Length	4.89"	4.89"
B Width	2.66"	2.66"
C Depth	4.00"	4.00"

MODEL

L3DA4U1UKL-CV240

Hi-lume™ 1% EcoSystem Voltage
LED Driver

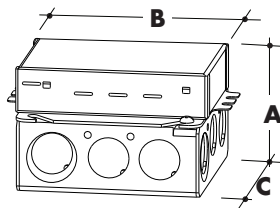

MODEL

L3DO-96W24V-U

Hi-lume™ 0.1% EcoSystem Voltage
LED Driver with Soft-On, Fade-to-Black™

MODELS	L3DO
A Length	10.50"
B Width	5.50"
C Depth	2.00"

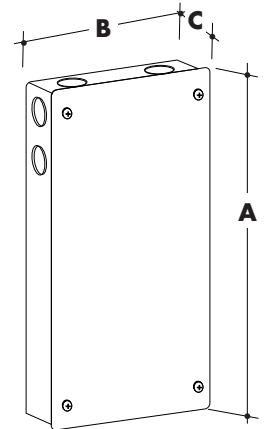

Power supply

See fixture and power supply instructions & spec sheet for wiring information. Dimming possible in select models - view Luminii website for list of compatible dimmers.

Enlighted Enabled Dimming Power Supplies:

MODEL	POWER	OUTPUT	DIMMING	Location
PSV	96	24	ENL	D
PSV- LED Power Supply	96 - 96 WATT	24 - 24 VDC	ENL - Enlighted Dimming	D - Damp

MODELS	96 W
A Length	14.40"
B Width	5.20"
C Depth	2.60"

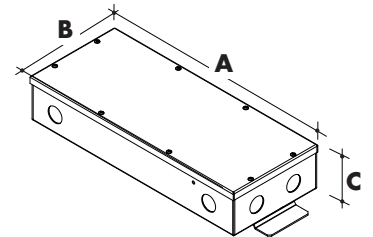

Non-Dimming Power Supplies:

MODEL	POWER	OUTPUT	DIMMING	LOCATION
PSV	40	24	U2ND	D
PSV - PSV Series	40 - 40 W 60 - 60 W 96 - 96 W	24 - 24 VDC	U2ND - Non Dimming	D - Dry Location IP65 - Wet Location

MODELS	PSV Dry	PSV Wet
A Length	9.2"	9.5"
B Width	3.4"	4.12"
C Depth	1.9"	2.3"

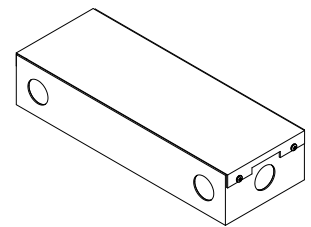

In ground, Electronic Low Voltage Dimming Power Supplies:

MODEL	CIRCUIT x POWER	OUTPUT	INPUT
IG-CVE	96X2	24	
IG-CVE - In ground CVE Series dims down to 0.1%	96X2 - 2 x 96W	24 - 24 VDC	Blank - 120 V 277 - 240/277 V

MODELS	Dual circuit
A Length	8.0"
B Width	8.0"
C Depth	8.0"

