

Myka - Installation Instructions

Models MK-XX

Please read all instructions prior to installation and keep for future reference!

1. PRODUCT TO BE INSTALLED BY A QUALIFIED ELECTRICIAN.
2. USE ONLY WITH CLASS 2 POWER UNIT.
3. 24 VOLTS DC.
4. SUITABLE FOR DAMP LOCATIONS.
5. SURFACE MOUNT ONLY
6. SUITABLE FOR INSTALLATION WITHIN THE CLOSET STORAGE SPACE WHEN USED WITH TAPE OUTPUTS 5.7W/FT OR LESS
7. INHERENTLY PROTECTED



REVO.3
02022024

1 / 6



7777 Merrimac Ave
Niles, IL 60714
T 224.333.6033
F 224.757.7557
info@luminii.com
www.luminii.com

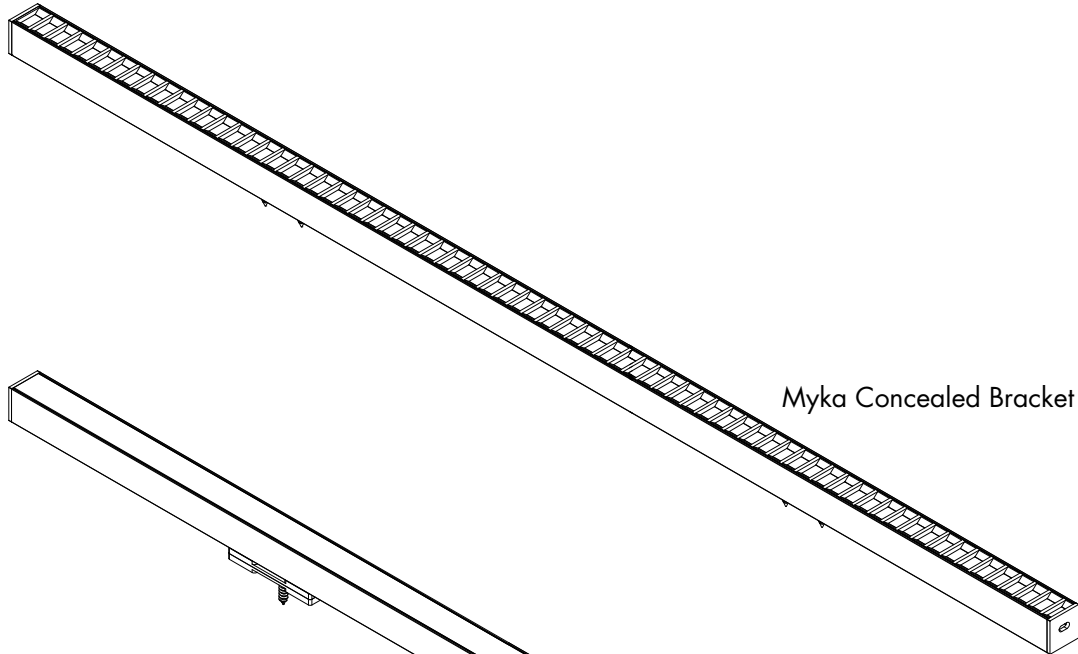

Myka Concealed Bracket Mounting

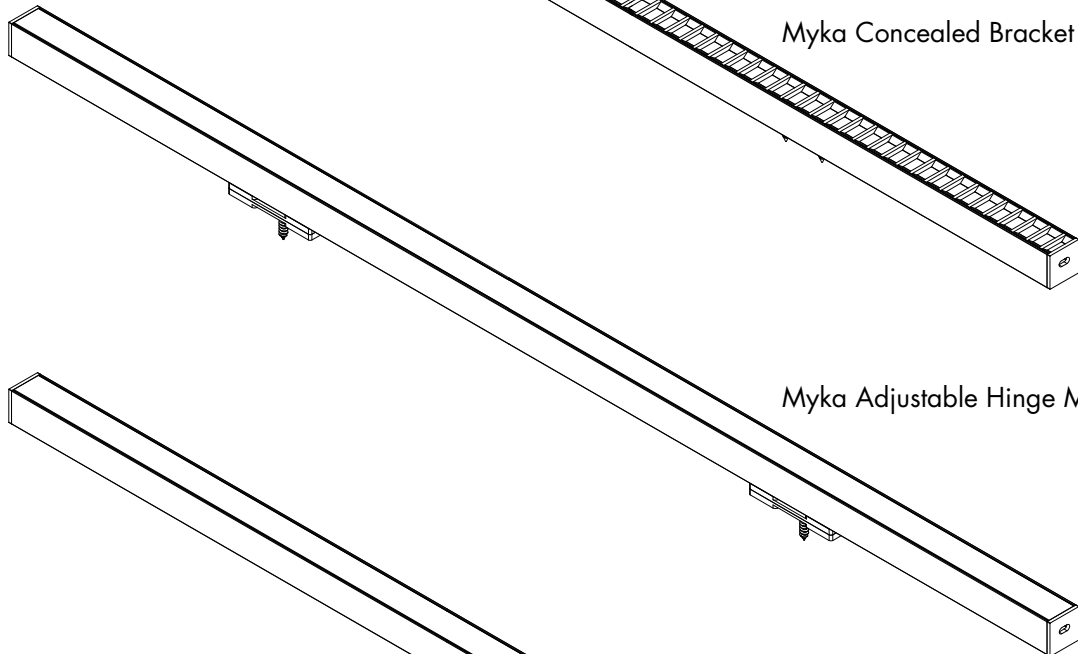

Myka Adjustable Hinge Mounting

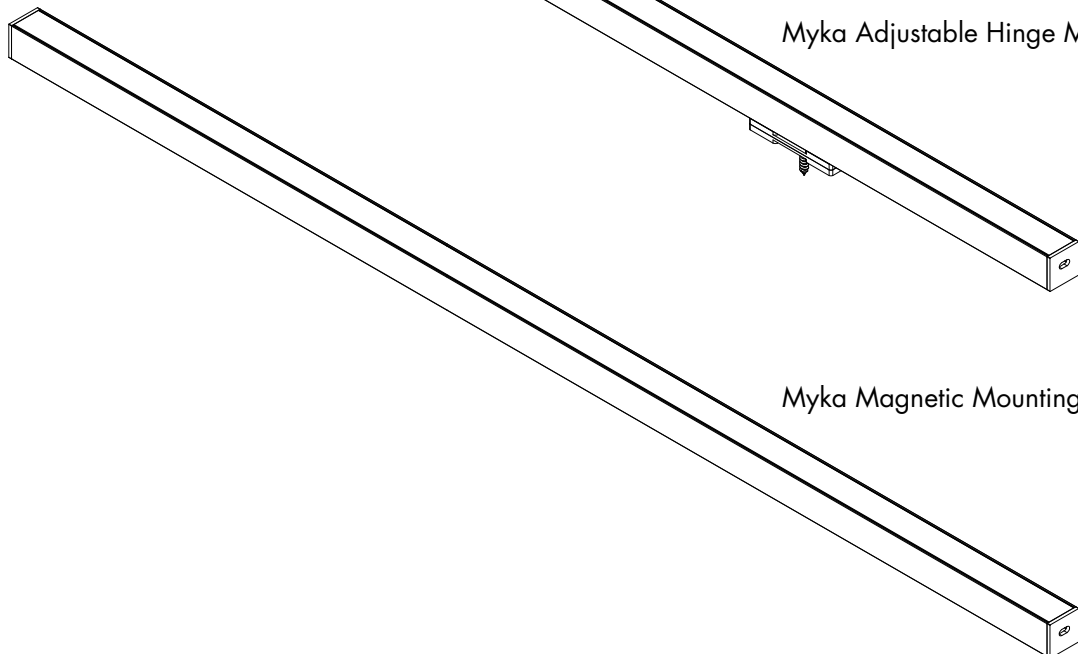

Myka Magnetic Mounting

Myka - Installation Instructions

Models MK-XX

Please read all instructions prior to installation and keep for future reference!

1. PRODUCT TO BE INSTALLED BY A QUALIFIED ELECTRICIAN.
2. USE ONLY WITH CLASS 2 POWER UNIT.
3. 24 VOLTS DC.
4. SUITABLE FOR DAMP LOCATIONS.
5. SURFACE MOUNT ONLY.
6. SUITABLE FOR INSTALLATION WITHIN THE CLOSET STORAGE SPACE WHEN USED WITH TAPE OUTPUTS 5.7W/FT OR LESS.
7. INHERENTLY PROTECTED.



REV0.3
02022024

2 / 6



7777 Merrimac Ave
Niles, IL 60714
T 224.333.6033
F 224.757.7557
info@luminii.com
www.luminii.com

Magnetic Installation

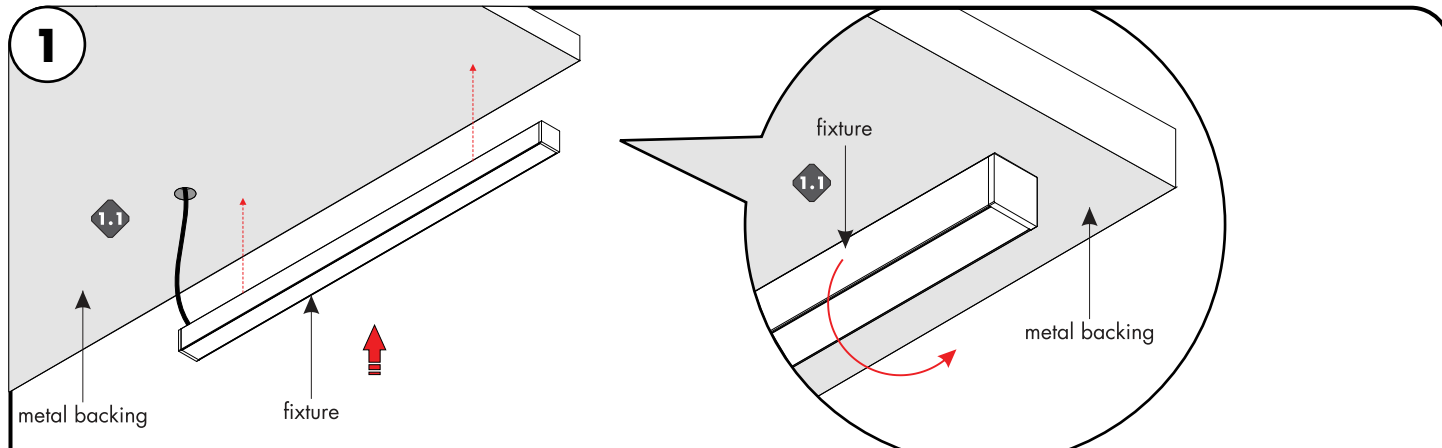

Note: : Prior to installation all 24VDC wires must be present near fixture. Refer to the power supply installation instruction for additional information.

Note: More than one person is recommended for this installation.

1.1 Determine the location of the fixture. Must be made of steel or a ferrous metal. Clean the surface area thoroughly from any debris. Snap the fixture onto the metal surface. If necessary fixture can easily be removed by rotating off the surface and repositioning correctly.

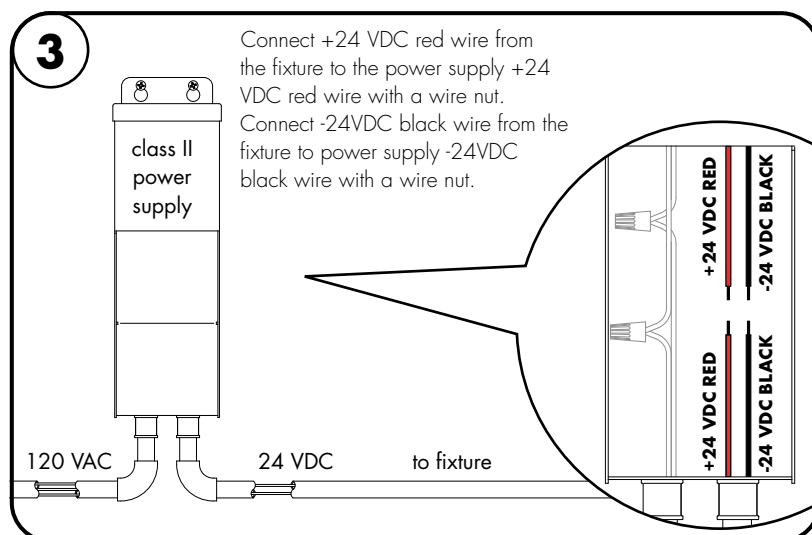
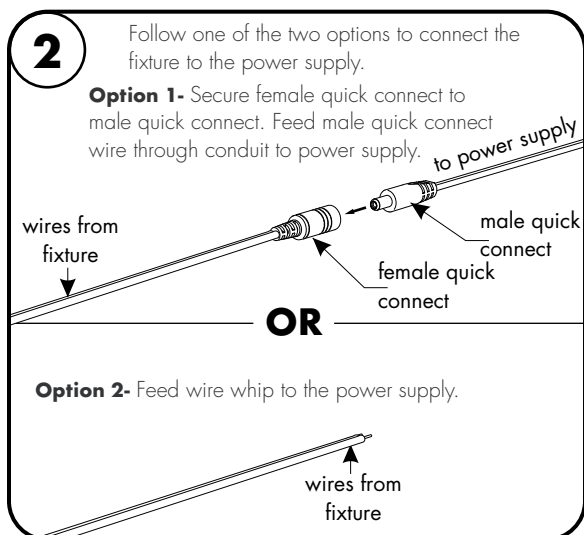

Myka - Installation Instructions

Models MK-XX



7777 Merrimac Ave
Niles, IL 60714
T 224.333.6033
F 224.757.7557
info@luminii.com
www.luminii.com

REVO.3
02022024

3 / 6

Please read all instructions prior to installation and keep for future reference!

1. PRODUCT TO BE INSTALLED BY A QUALIFIED ELECTRICIAN.
2. USE ONLY WITH CLASS 2 POWER UNIT.
3. 24 VOLTS DC.
4. SUITABLE FOR DAMP LOCATIONS.
5. SURFACE MOUNT ONLY.
6. SUITABLE FOR INSTALLATION WITHIN THE CLOSET STORAGE SPACE WHEN USED WITH TAPE OUTPUTS 5.7W/FT OR LESS.
7. INHERENTLY PROTECTED.

Concealed Bracket Installation

1

1.1 Determine the location of where the fixture(s) will be installed. Lay the fixture(s) on the surface, and make any necessary reference marks for the concealed mounting brackets. Make marks 4" from each end of the fixture(s) and also every 23" in between.

1.2 Lay the concealed bracket onto the reference mark points and secure using the provided hardware.

2

2.1 If necessary make any pass through holes for wire lead/connector to the surface, depending on the power feed option. Then snap the fixture into the concealed bracket to secure in place.

3

3.1 Follow one of the two options to connect the fixture to the power supply.

Option 1- Secure female quick connect to male quick connect. Feed male quick connect wire through conduit to power supply.

OR

Option 2- Feed wire whip to the power supply.

4

Connect +24 VDC red wire from the fixture to the power supply +24 VDC red wire with a wire nut.
Connect -24VDC black wire from the fixture to power supply -24VDC black wire with a wire nut.

Myka - Installation Instructions

Models MK-XX



7777 Merrimac Ave
Niles, IL 60714
T 224.333.6033
F 224.757.7557
info@luminii.com
www.luminii.com

REVO.3

02022024

4 / 6

Please read all instructions prior to installation and keep for future reference!

1. PRODUCT TO BE INSTALLED BY A QUALIFIED ELECTRICIAN.
2. USE ONLY WITH CLASS 2 POWER UNIT.
3. 24 VOLTS DC.
4. SUITABLE FOR DAMP LOCATIONS.
5. SURFACE MOUNT ONLY
6. SUITABLE FOR INSTALLATION WITHIN THE CLOSET STORAGE SPACE WHEN USED WITH TAPE OUTPUTS 5.7W/FT OR LESS
7. INHERENTLY PROTECTED

Adjustable Hinge Installation

1

1.1 Slightly loosen both screws on the sides of the hinge bracket. Rotate the fixture to expose mounting hole.

2

Note: : Prior to installation all 24VDC wires must be present near fixture. Refer to the power supply installation instruction for additional information. Note: More than one person is recommended for this installation.

2.1 Determine the location of the fixture. Then secure the fixture to the surface using the provided mounting screws.

2.2 Rotate the fixture to the desired angle then tighten the side screws to secure.

3

Follow one of the two options to connect the fixture to the power supply.

Option 1- Secure female quick connect to male quick connect. Feed male quick connect wire through conduit to power supply.

OR

Option 2- Feed wire whip to the power supply.

4

Connect +24 VDC red wire from the fixture to the power supply +24 VDC red wire with a wire nut. Connect -24VDC black wire from the fixture to power supply -24VDC black wire with a wire nut.

120 VAC

24 VDC to fixture

Myka - Installation Instructions

Models MK-XX



7777 Merrimac Ave
Niles, IL 60714
T 224.333.6033
F 224.757.7557
info@luminii.com
www.luminii.com

Please read all instructions prior to installation and keep for future reference!

1. PRODUCT TO BE INSTALLED BY A QUALIFIED ELECTRICIAN.
2. USE ONLY WITH CLASS 2 POWER UNIT.
3. 24 VOLTS DC.
4. SUITABLE FOR DAMP LOCATIONS.
5. SURFACE MOUNT ONLY
6. SUITABLE FOR INSTALLATION WITHIN THE CLOSET STORAGE SPACE WHEN USED WITH TAPE OUTPUTS 5.7W/FT OR LESS
7. INHERENTLY PROTECTED

REVO.3
02022024
5 / 6

power supplies at the end of the run

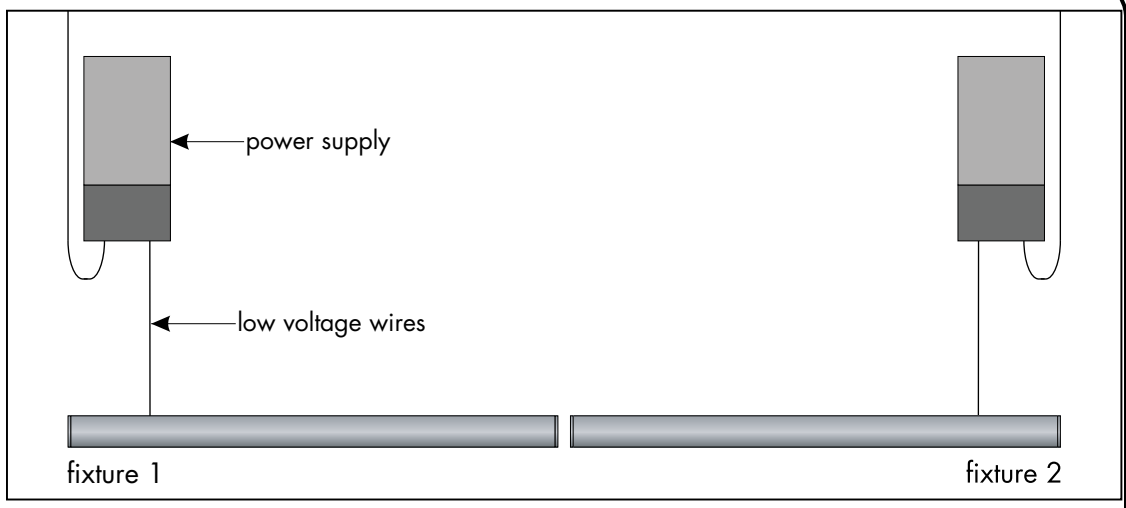

power supplies in the middle of the run

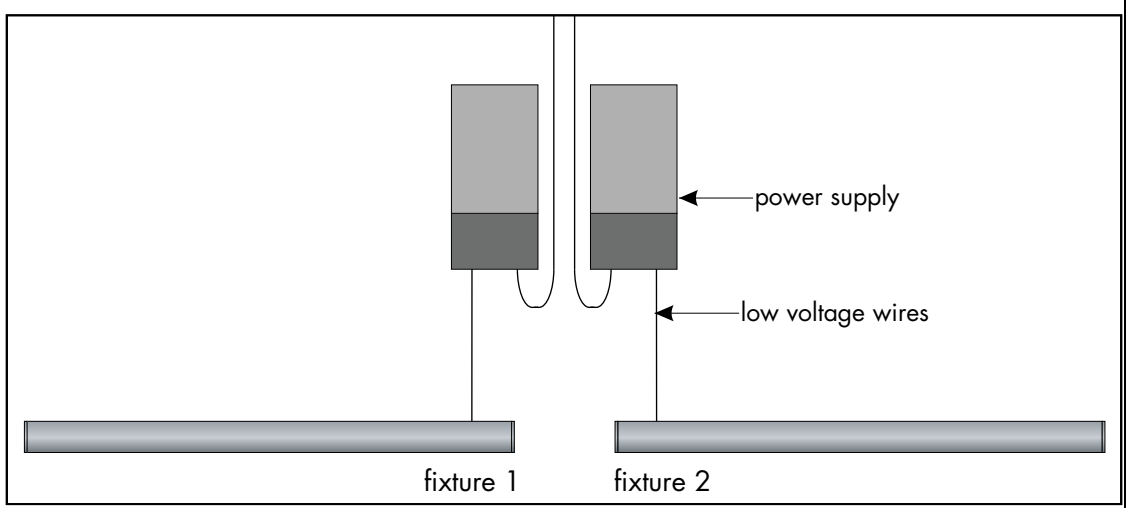

consecutive layout, NOT RECOMMENDED

