

Designed with high efficacy and minimal size in mind, the mCove lighting system is available with long throw and tall throw reflectors, multiple light outputs and color temperature. The Black, and White finishes are complemented by a paint ready option. Individual fixtures connect easily together to reach long continuous run with no visible dark spots. Remote power supplies required. Approved for closet/storage space installation per NEC 410.16(A)(3) and 410.16(C)(5).

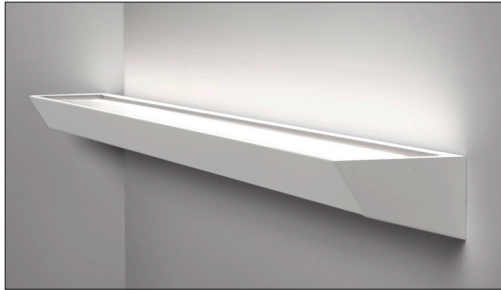

dimensions

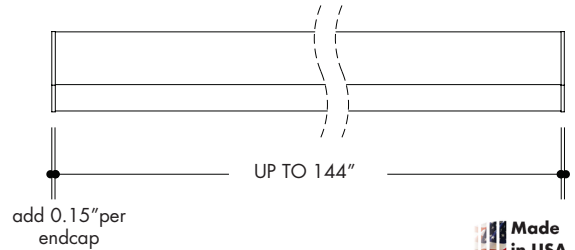
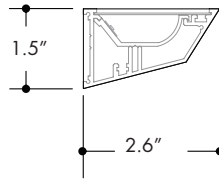

reflector options

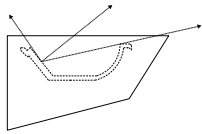

Long Throw

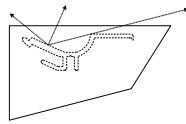

Tall Throw

corner options

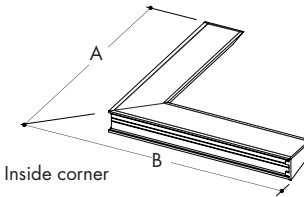

Inside corner

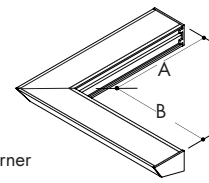

Outside corner



RoHS Compliant



Finish options



Black powder coated



White powder coated



Paint Ready

Technical information

OUTPUT OPTIONS

Output	Lumens at 3000K	Average power consumption at 4'	Lumens / Watt	Maximum system length In series
LO (LL48HE-LO)	231 lm/ft	2.0 W/ft	116 lm/W	55'
SO (LL48HE-SO)	328 lm/ft	2.8 W/ft	117 lm/W	38'
MO (LL48HE-MO)	440 lm/ft	3.7 W/ft	119 lm/W	27'
HO (LL48HE-HO)	706 lm/ft	5.9 W/ft	120 lm/W	17'

CCT INFO/LUMEN MULTIPLIER

Color temperature	Multiplier (referenced from 3000K)	TM-30-15		
		CRI	R _f	R _g
2700K	0.94	92	90	99
3000K	1.00	92	89	99
3500K	1.02	92	89	99
4000K	1.02	92	86	94

Ordering code

MODEL	LENGTH	CCT	OUTPUT	REFLECTOR	FINISH	LEFT END	RIGHT END	POWER FEED	
M - Micro Cove	HE - High Efficacy	12" - 144" 4" increments	27K - 2700K 30K - 3000K 35K - 3500K 40K - 4000K	LO - Low SO - Standard MO - Medium HO - High	LT - Long Throw TT - Tall Throw	BK - Black WH - White PR - Paint Ready	LE - W/ end cap LN - WO/ end cap	RE - W/ end cap RN - WO/ end cap	PFL - Power feed left PFR - Power feed right NPF - No Power feed

*Refer to the sample layout on page 3, to choose the correct end cap & power feed.

Photometry

M-HE-48-30K-HO-IT-XX

M-HE-48-30K-SO-IT-XX

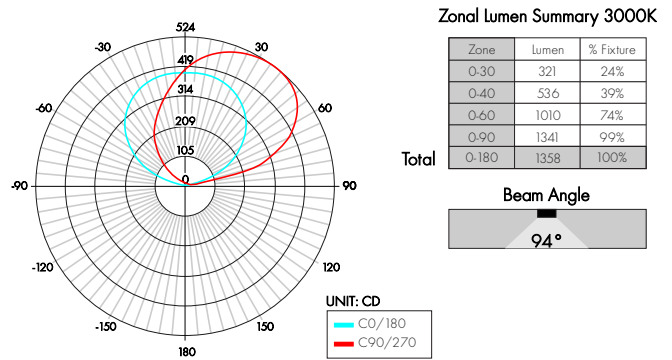
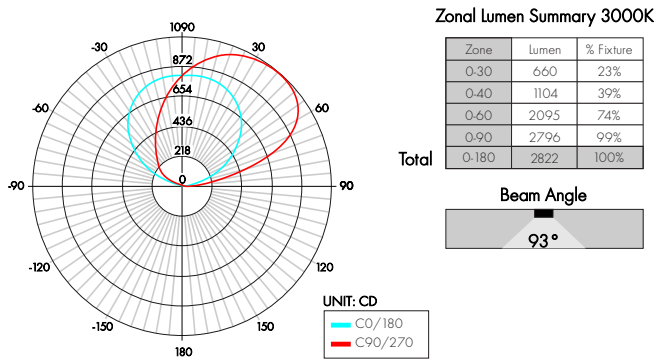

Power consumption per fixture length

Based on operation with PSD series of power supplies.



Length		LO		SO		MO		HO	
Nominal	Actual	W/ft	Total wattage	W/ft	Total wattage	W/ft	Total wattage	W/ft	Total wattage
12"	12-13/16"	2.00	2.00	2.79	2.79	3.70	3.70	5.90	5.90
16"	16-12/16"	2.00	2.67	2.79	3.72	3.70	4.90	5.90	7.88
20"	20-11/16"	2.00	3.33	2.79	4.65	3.70	6.10	5.90	9.86
24"	24-10/16"	2.00	4.00	2.79	5.58	3.70	7.40	5.90	11.84
28"	28-9/16"	2.00	4.67	2.79	6.51	3.70	8.63	5.91	13.81
32"	32-8/16"	2.00	5.34	2.79	7.44	3.70	9.83	5.91	15.78
36"	36-7/16"	2.00	6.00	2.79	8.37	3.70	11.10	5.91	17.75
40"	40-6/16"	2.00	6.66	2.79	9.30	3.70	12.33	5.92	19.74
44"	44-5/16"	2.00	13.33	2.79	10.23	3.70	13.56	5.92	21.73
48"	48-4/16"	2.00	8.00	2.79	11.16	3.70	14.80	5.92	23.72
52"	52-3/16"	2.00	8.67	2.79	12.09	3.70	16.03	5.92	25.70
56"	56-2/16"	2.00	9.34	2.79	13.02	3.70	17.26	5.92	27.68
60"	60-1/16"	2.00	10.00	2.79	13.95	3.70	18.50	5.92	29.66
64"	65-15/16"	2.00	10.67	2.79	15.82	3.70	19.73	5.93	31.64
68"	69-14/16"	2.00	11.34	2.79	17.69	3.70	20.96	5.93	33.62
72"	73-13/16"	2.00	12.00	2.79	19.56	3.70	22.20	5.93	35.60
76"	77-12/16"	2.00	12.67	2.79	20.48	3.70	23.43	5.91	37.53
80"	81-12/16"	2.00	13.37	2.79	21.40	3.70	24.66	5.91	39.46
84"	85-10/16"	2.00	14.00	2.79	22.32	3.70	25.90	5.91	41.40
88"	89-9/16"	2.00	14.67	2.79	23.25	3.70	27.13	5.92	43.40
92"	93-8/16"	2.00	15.37	2.79	24.18	3.70	28.36	5.92	45.40
96"	97-7/16"	2.00	16.00	2.79	25.10	3.70	29.60	5.92	47.45
100"	101-7/16"	2.00	16.67	2.79	26.03	3.70	30.93	5.94	49.45
104"	105-5/16"	2.00	17.37	2.79	26.96	3.70	32.26	5.94	51.45
108"	109-4/16"	2.00	18.00	2.79	27.90	3.73	33.60	5.94	53.50
112"	113-3/16"	2.00	18.67	2.79	28.85	3.73	34.93	5.99	55.30
116"	117-2/16"	2.00	19.37	2.79	29.80	3.73	36.26	5.99	57.10
120"	121-2/16"	2.00	20.00	2.79	30.75	3.76	37.60	5.99	58.90
124"	125 "	2.00	20.67	2.79	31.70	3.76	38.80	5.85	60.70
128"	128-15/16"	2.00	21.34	2.79	32.65	3.76	40.00	5.85	62.50
132"	132-14/16"	2.00	22.00	2.79	33.60	3.74	41.20	5.85	64.30
136"	136-14/16"	2.00	22.67	2.79	34.55	3.74	42.40	5.82	66.10
140"	140-13/16"	2.00	23.34	2.79	35.50	3.74	43.60	5.82	67.90
144"	144-11/16"	2.00	24.00	2.80	36.45	3.73	44.80	5.82	69.68

*add an addition 0.15" for each endcap used

Sample layout of powerfeed connections

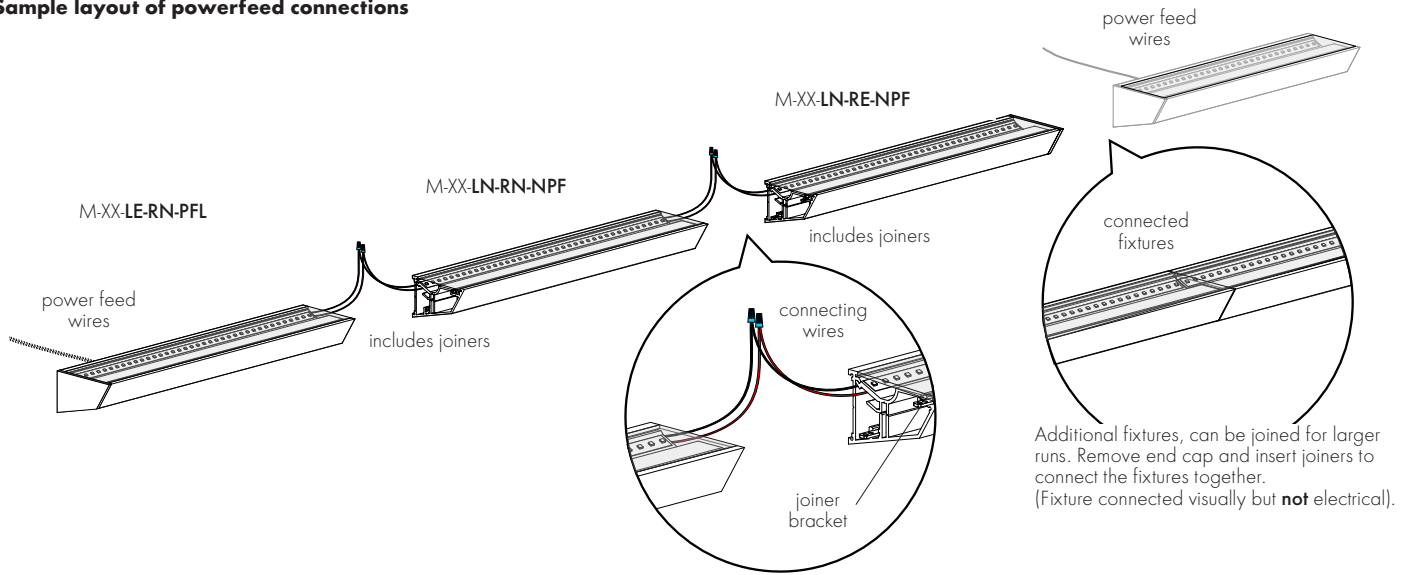

join fixtures together

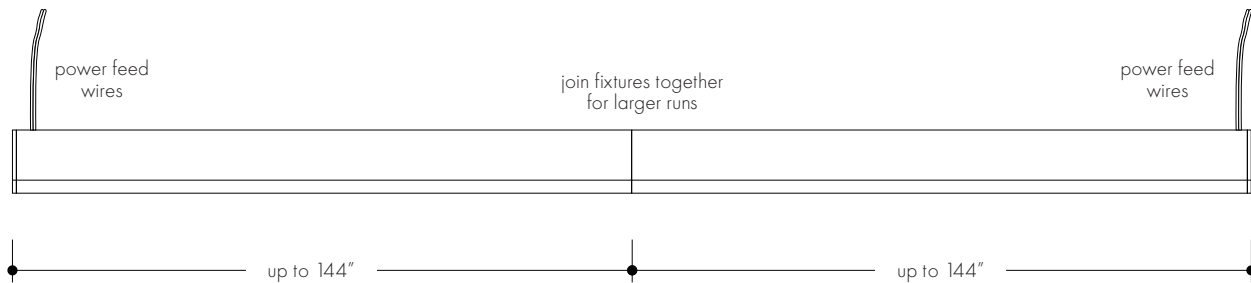

mCove corner

Sample layout of mCove corners with powerfeed connections

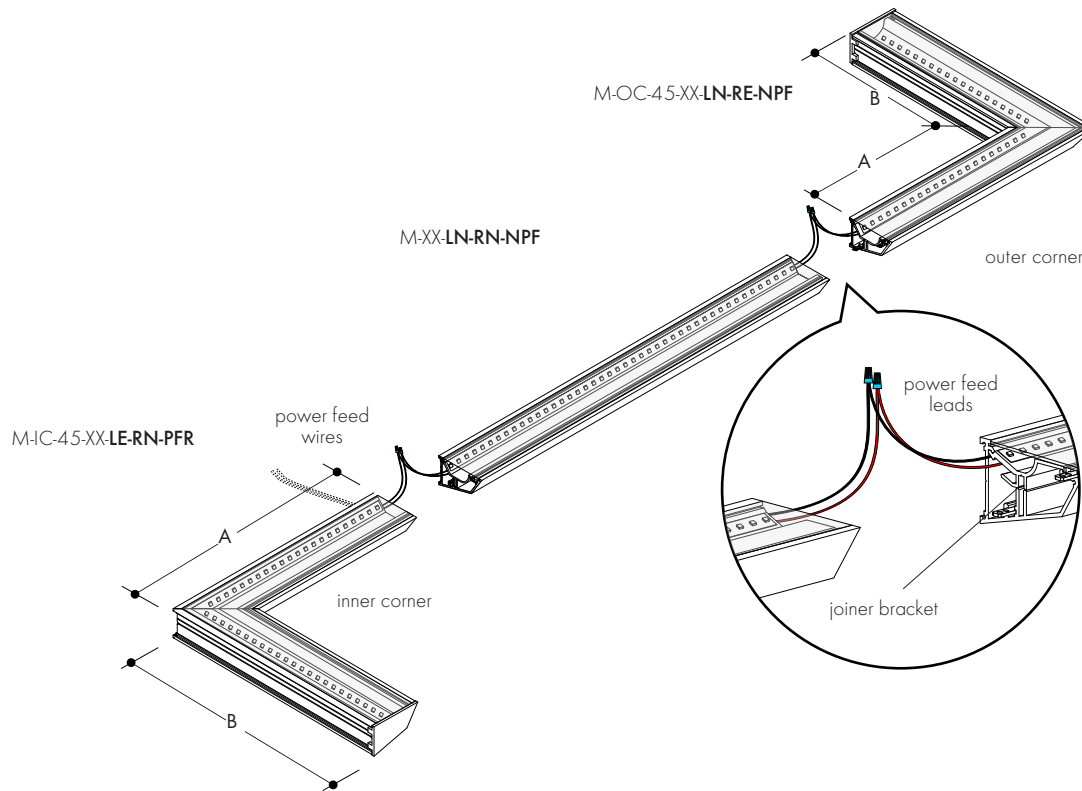

Ordering code

MODEL	CORNER TYPE	ANGLE	CCT	OUTPUT	REFLECTOR	FINISH	LEFT END	RIGHT END	POWER FEED	
M	HE	IC	90	27K	LO	LT	BK	LE	RE	PFL
M - Micro Cove	HE - High Efficacy	IC - Inside corner OC - Outside corner	90 - 90° C - Custom°	27K - 2700K 30K - 3000K 35K - 3500K 40K - 4000K	LO - Low SO - Standard MO - Medium HO - High	LT - Long Throw TT - Tall Throw	BK - Black WH - White PR - Paint Ready	LE - W/ end cap LN - WO/ end cap	RE - W/ end cap RN - WO/ end cap	PFL - Power feed left PFR - Power feed right NPF - No Power feed

Power consumption per Corner type

Based on operation with PSD series of power supplies.

Inside Corner Type (output)	Actual length (AxB)	Total wattage	Outside Corner Type (output)	Actual length (AxB)	Total wattage
LO	12-3/16" x 12-3/16"	4.00 W	LO	10" x 10"	3.33 W
SO	12-3/16" x 12-3/16"	5.60 W	SO	10" x 10"	4.65 W
MO	12-3/16" x 12-3/16"	7.40 W	MO	10" x 10"	6.10 W
HO	12-3/16" x 12-3/16"	11.84 W	HO	10" x 10"	9.86 W

Power supply

See fixture and power supply instructions & spec sheet for wiring information. Dimming possible in select models - view Luminii website for list of compatible dimmers.

Magnetic Low Voltage Dimming Power Supplies:

MODEL	POWER	OUTPUT	INPUT
PSD	48	24	
PSD - PSD Series dims down to 0%	48 - 48 Watt 96 - 96 Watt 288 - 288 Watt (3 x 96Watt)	24 - 24 VDC	Blank - 120 V 240 - 240 V 277 - 277 V

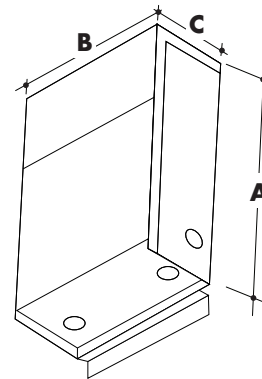

MODELS	PSD 48	PSD 96	PSD 288
A Length	11.25"	11.25"	13.06"
B Width	3.42"	3.42"	8.42"
C Depth	3.42"	3.27"	4.47"

Electronic Low Voltage Dimming Power Supplies:

MODEL	POWER	OUTPUT
PDCL	30	24
PDCL - PURE DC LITE Dims to 1% on most MLV Dimmers NOTE: Must be loaded at least 10% of rated load to obtain optimal dimming.	30 - 30 Watt 60 - 60 Watt 96 - 96 Watt	24 - 24 VDC

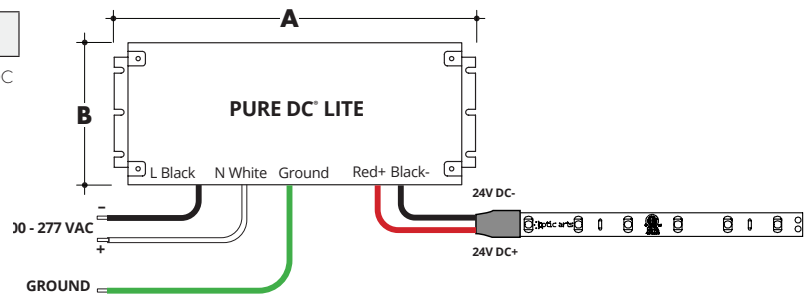

MODELS	PDCL 30	PDCL 60	PDCL 96
A Length	1.03"	1.03"	1.03"
B Width	6.50"	7.40"	8.66"
Depth	3.62"	3.62"	3.66"

0-10V Dimming Power Supplies

MODEL	POWER	OUTPUT	DIMMING
PS010V	3X96	24	LIN
PS010V - 0-10V Power Supply dims down to 0%	96 - 96 Watt 3X96 - 3 X 96 Watt	24 - 24 VDC	LIN - Linear LOG - Logarithmic

MODELS	96W	3X96
A Length	14.40"	15.75"
B Width	5.20"	6.60"
C Depth	2.60"	4.80"

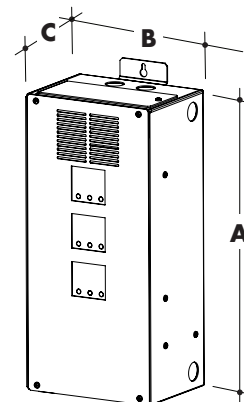

MODEL	POWER	OUTPUT	DIMMING	LOCATION
PSV	40	24	U2DIM	D
PSV - PSV Series dims down to 5%	40 - 40 Watt 60 - 60 Watt 96 - 96 Watt	24 - 24 VDC	U2DIM - Dimming 0 - 10V	D - Dry Location IP65 - Wet Location

MODELS	PSV Dry	PSV Wet
A Length	9.20"	9.50"
B Width	3.40"	4.12"
C Depth	1.90"	2.30"

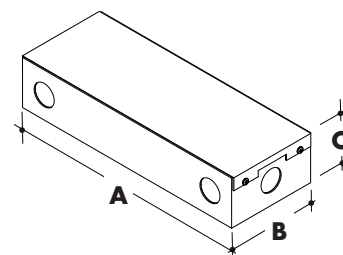

Power supply

See fixture and power supply instructions & spec sheet for wiring information. Dimming possible in select models - view Luminii website for list of compatible dimmers.

DMX Dimming Power Supplies

MODEL	POWER	OUTPUT
PSDMX	96	24
PSD - DMX Power Supply	96 - 96 Watt 3X96 - 3 X 96 Watt	24 - 24 VDC

Features eldoLED's LINEARdrive configurable dimmable drivers

MODELS	3X96 W
A Length	15.75"
B Width	6.60"
C Depth	4.80"

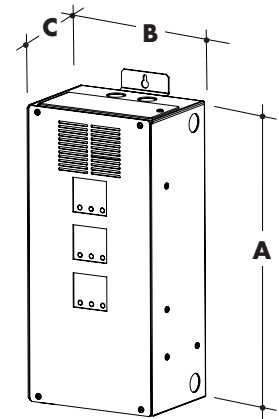

DALI Dimming Power Supplies

MODEL	POWER	OUTPUT
PSDALI	96	24
PSDALI - DALI Power Supply dims down to 0%	96 - 96 Watt 3X96 - 3 X 96 Watt	24 - 24 VDC

Features eldoLED's LINEARdrive configurable dimmable drivers

MODELS	96 W
A Length	14.40"
B Width	5.20"
C Depth	2.60"

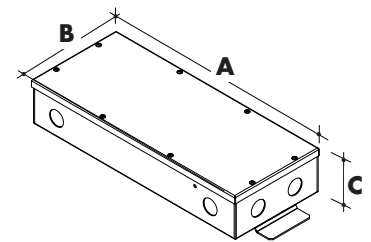

Luminii is a Lutron OEM Advantage Partner

MODEL
LTEA4U1UKL-CV240
Lutron - HiLume™ 1% 2-wire LED driver (120V forward phase only)

MODEL
L3DA4U1UKL-CV240
HiLume™ 1% EcoSystem Voltage LED driver

MODELS	LTEA	L3DA
A Length	4.89"	4.89"
B Width	2.66"	2.66"
C Depth	4.00"	4.00"

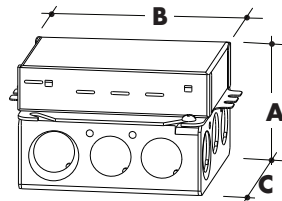

MODEL
L3D0-96W24V-U
HiLume™ 0.1% EcoSystem Voltage LED Driver with Soft-On, Fade-to-Black™

MODELS	L3D0
A Length	10.50"
B Width	5.50"
C Depth	2.00"

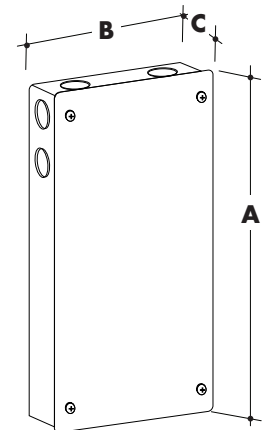

Power supply

See fixture and power supply instructions & spec sheet for wiring information. Dimming possible in select models - view Luminii website for list of compatible dimmers.

Enlighted Enabled Dimming Power Supplies:

MODEL	POWER	OUTPUT	DIMMING	LOCATION
PSV	96	24	ENL	D
PSV - PSV Series	96 - 96 Watt	24 - 24 VDC	ENL - Enlighted Dimming	D - Damp

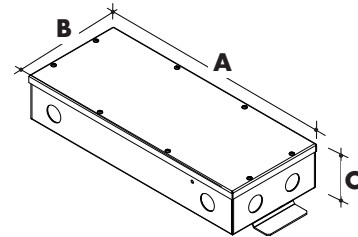

MODELS	96W
A Length	14.40"
B Width	5.20"
C Depth	2.60"

Non-Dimming Power Supplies:

MODEL	POWER	OUTPUT	DIMMING	LOCATION
PSV	40	24	U2ND	D
PSV - PSV Series	40 - 40 Watt 60 - 60 Watt 96 - 96 Watt	24 - 24 VDC	U2ND - Non Dimming	D - Dry Location IP65 - Wet Location

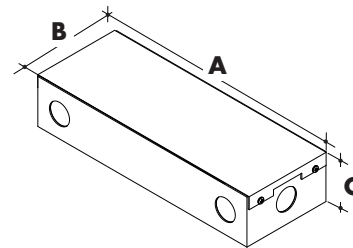

MODELS	PSV Dry	PSV Wet
A Length	9.2"	9.5"
B Width	3.4"	4.12"
C Depth	1.90"	2.30"

In ground, Electronic Low Voltage Dimming Power Supplies:

MODEL	POWER	OUTPUT	INPUT
IG-CVE	96X2	24	
IG-CVE - In ground CVE Series dims down to 0.1%	96X2 - 2 X 96 Watt	24 - 24 VDC	Blank - 120 V 277 - 240/277 V

MODELS	Dual circuit
A Length	8.0"
B Width	8.0"
C Depth	8.0"

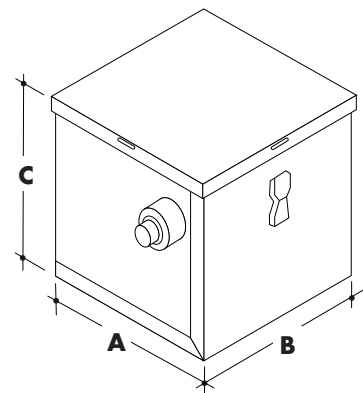

Power supply

See fixture and power supply instructions & spec sheet for wiring information. Dimming possible in select models - view Luminii website for list of compatible dimmers.

Universal Power Supply

MODEL	POWER	OUTPUT
PDCU	30	24
PDCU - PDCU Series	30 - 30 Watt 60 - 60 Watt 96 - 96 Watt 3x96 - 3x96 Watt	24 - 24 VDC

MODELS	30W	60W	96W	3X96
A Length	6.50"	7.40"	8.66"	11.83"
B Width	3.73"	3.73"	3.73"	4.32"
C Height	1.61"	1.61"	1.61"	1.81"

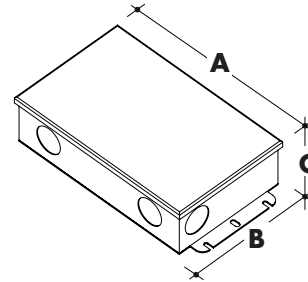

MODEL	POWER	OUTPUT	DIMMING	LOCATION
PSV	20	24	UDIM	D
PSV - PSV Series	20 - 20 Watt 40 - 40 Watt 60 - 60 Watt 96 - 96 Watt	24 - 24 VDC	UDIM - Universal Dimming	D - Dry Location

MODELS	20W	40W	60W	96W
A Length	8.15"	9.20"	9.20"	9.20"
B Width	2.00"	3.40"	3.40"	3.40"
C Height	1.70"	1.90"	1.90"	1.90"

