



Features

LLRGBW36 is a small profile LED strip incorporating 4 discrete emitters in each LED - red, green, blue, and 3000K white. Increased pitch provides more continuous light, while a High Output option offers incredible brightness. Luminii attention to color quality provides balanced output across the color gamut, as well as true, balanced white.

Mounting

LLRGBW36 strip is equipped with 3M™ adhesive transfer tape (9472LE). LLRGBW36-HO must be paired with an approved Luminii extrusion.

Applications

Indoor only - millwork, cove, architectural reveals, undercabinet, display case, handrail, accent lighting

Approvals

Class 2 damp listed

Operating voltage

24 VDC

Life (L70)

50,000 hours

Warranty

5 years



Technical Specifications

MODEL	LLRGBW36	
OUTPUT OPTIONS	SO	HO
LEDs/ft	36	36
Light Output*	219 lm/ft	351 lm/ft
Average Power Consumption* (for 4' Section)	4.3 W/ft	8.2 W/ft
Cutting Increment	1.97"	
Pitch Length	0.33"	
Efficacy	51 lm/W	43 lm/W
Maximum Run Length (in series)	26 ft	13 ft
Dimensions	0.39" W x 0.07" H	

*all channels full on

TM-30 (3000K)	CRI	R _f	R _g	R ₉
LLRGBW36-SO	95	94	106	82
LLRGBW36-HO	95	93	106	84

Color	Dominant Wavelength
Red	620nm
Green	525nm
Blue	467nm

SECTION START/END OPTION

No connector

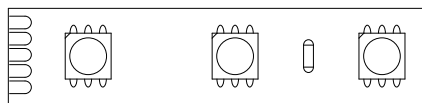

Soldered lead wires (72")

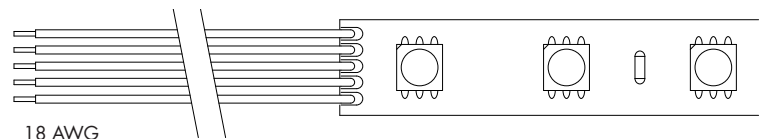

Ordering Code

MODEL	OUTPUT	SECTION START	SECTION END	LENGTH
LLRGBW36 - Red, green, blue, and white	SO - Standard HO - High	SL - Soldered lead wires (72") NC - No connector	SL - Soldered lead wires (72") NC - No connector	View specifications for increment options

Power Consumption Per Linear Foot

Tested with PSD series of power supply (page 4)

LLRGBW36				
Nominal Length	SO		HO	
	W/ft	Total wattage	W/ft	Total wattage
1	4.4	4.4	8.1	8.1
2	4.1	8.1	8.1	16.1
3	4.2	12.6	8.1	24.3
4	4.3	17.2	8.2	32.7
5	4.3	21.3	8.1	40.5
6	4.3	25.7	8.2	49.1
7	4.3	30.1	8.2	57.1
8	4.3	34.2	8.0	63.6
9	4.2	37.8	7.6	68.2
10	4.3	42.9	7.6	76.3
11	4.2	46.6	7.6	83.1
12	4.2	50.6	7.3	88.0
13	4.2	54.0	7.1	92.2
14	4.1	57.9		
15	4.1	60.9		
16	4.0	64.4		
17	3.9	66.7		
18	3.9	70.4		
19	3.8	73.0		
20	3.8	75.8		
21	3.8	79.3		
22	3.7	81.2		
23	3.6	82.1		
24	3.5	83.7		
25	3.5	87.7		
26	3.4	88.4		

Accessories

CL1

Mounting clip recommended every 12" when LineLED strip is facing down

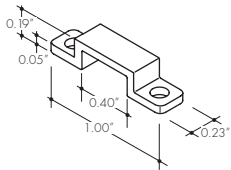

LL.ZIP

Strain relief clip for wire management

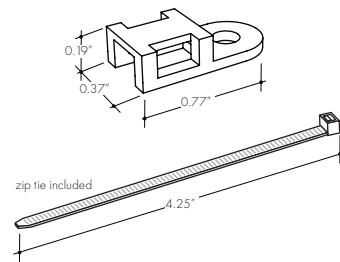

Lens Options / Light Transmission

- C** Clear
- HF** Half (50%) Frosted
- G** Graze
- SI** Satin Ice
- S** Square Frosted
- Q** Rounded Square Frosted
- F** Frosted
- M** Medium beam frosted
- R** Raised
- C36** Clear 36° beam angle
- C10** Clear 10° beam angle

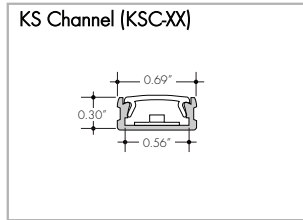

- C** 85%
- F** 55%
- HF** 72%
- C36** 83%
- R** 51%

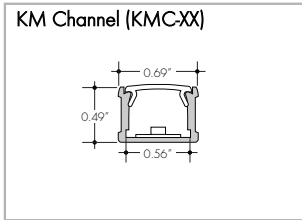

- C** 71%
- F** 42%
- HF** 58%
- C10** 67%
- R** 39%

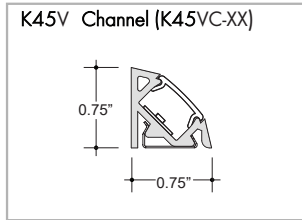

- C** 71%
- F** 42%
- HF** 58%
- C10** 67%

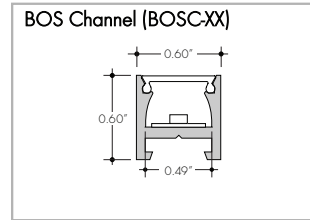

- F** 43%
- SI** 56%
- R** 46%
- G** 67%

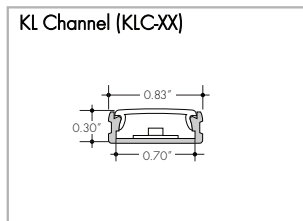

- C** 83%
- F** 55%
- HF** 68%

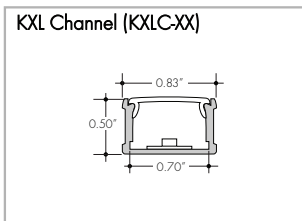

- C** 74%
- F** 46%
- HF** 61%

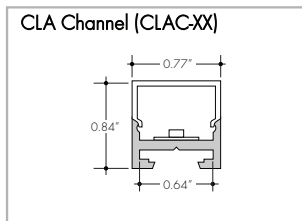

- S** 62%
- Q** 63%

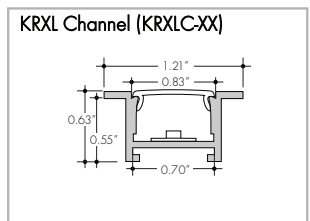

- C** 74%
- F** 46%
- HF** 61%

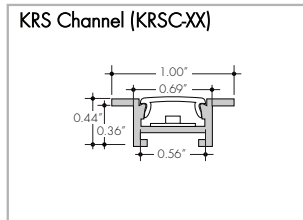

- C** 85%
- F** 55%
- HF** 72%

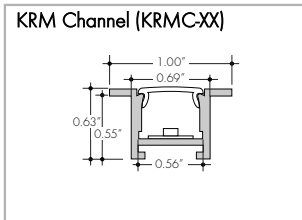

- C** 71%
- F** 42%
- HF** 58%

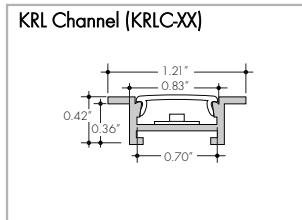

- C** 83%
- F** 55%
- HF** 68%

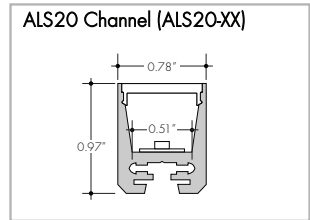

- C** 78%
- F** 43%

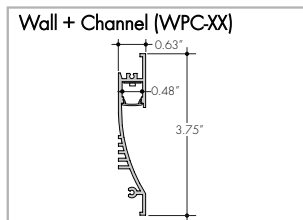

- C** 47%
- F** 44%

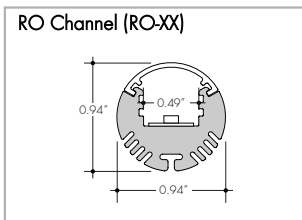

- C** 75%
- F** 52%

LED Dotting Per Extrusion

Using the Frosted Lens Option

Extrusion	SO	HO
KSC, KRSC	CD	CD
KMC, KRMC, K45VC, K45RC	SD	SD
KXLC, KRXLC	ND	ND
KLC, KRLC	CD	CD
WPC	CD	CD
RO, ALS20	ND	ND
BOSC	CD	CD
CLAC	ND	ND
KILOC, KILOC	ND	ND



CD - Clear Dotting
SD - Slight Dotting
ND - No Dotting

Installation

All mounting channels are field cuttable using miter saw with circular blade suitable for cutting aluminum.

Ordering

Extrusions are sold separately. View respective specsheets for details on ordering extrusions and their accessories (endcaps, mounting brackets, etc).

Power Supplies

See fixture and power supply instructions & spec sheet for wiring information. Dimming possible in select models - view luminii website for list of compatible dimmers.

Triac, MLV, ELV, & PWM Compatible Dimmers

MODEL	POWER	OUTPUT
PDC - (IP20) Power Supply	96 - 96 Watts	24 - 24 VDC

MODELS	96W
Length	8.25"
Width	4.10"
Depth	1.56"

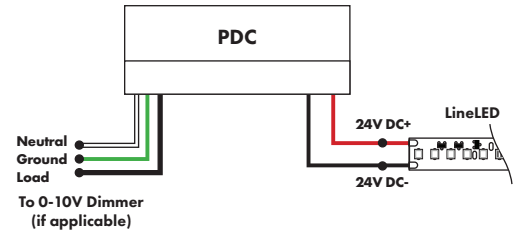

0-10V Warm Dimming 0% Power Supply 120VAC - 277VAC (for warm dimming of Dynamic White option)

MODEL	POWER	OUTPUT
PS010WD - 0-10 Warm dim LED Power Supply	96 - 96 Watt	24 - 24 VDC

Requires a 0-10V controller to work properly

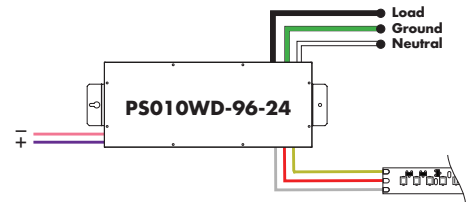

0-10V Tunable White 0% Dimming Power Supply 120VAC - 277VAC (for tunable white control of Dynamic White option)

MODEL	POWER	OUTPUT
PS010TW - 0-10 Tunable White LED Driver	96 - 96 Watt	24 - 24 VDC

Requires two 0-10V controllers to work properly

MODELS	PS010TW
A Length	14.40"
B Width	2.60"
C Depth	5.20"

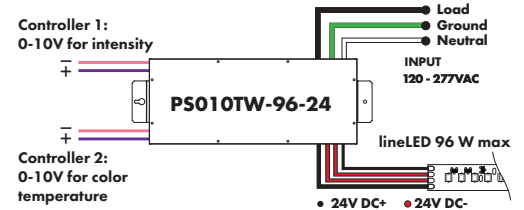

Customizable Dim to Warm or Variable White via 0 - 10V (for tunable white or warm dimming control of Dynamic option)

MODEL	POWER	OUTPUT	CONTROL
PS010V-0-10 LED Driver	96-96 Watt	24-24 VDC	WW - Standard One Channel - Dim To Warm Curve W2C - Standard Two Channel - Dim 1: Intensity; Dim 2: CCT W21 - Standard Two Channel - Dim 1: Warm Channel Intensity; Dim 2: Cool Channel Intensity W1X - Custom One Channel - Dim To Warm Curve W2X - Custom two Channel - Dim 1: Intensity; Dim 2: CCT

Requires a 0-10V controller to work properly

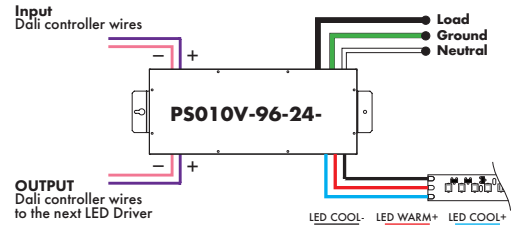

Non-Dimming Power Supply 120VAC - 277VAC

MODEL	POWER	OUTPUT	DIMMING	LOCATION
PSV - PSV Series	96 - 96 Watt	24 - 24 VDC	U2ND - Non Dimming	D - Dry location

Requires a controller and a decoder to work properly

MODELS	96W
A Length	14.40"
B Width	5.20"
Depth	2.60"

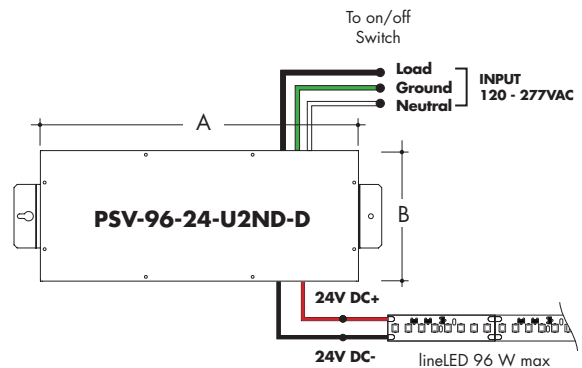

Power Supplies

See fixture and power supply instructions & spec sheet for wiring information. Dimming possible in select models - view Luminii website for list of compatible dimmers.

DMX 0% Dimming Power Supplies 120VAC - 277VAC

MODEL	POWER	OUTPUT
PSDMX-DMX Power Supply dims down to 0%	96 - 96 Watt 3X96 - 3 X 96 Watt	24-24 VDC

Features eldoLED's LINEARdrive configurable dimmable drivers.

DDMX-RGBW DMX Decoder not required when purchasing this power supply.

MODELS	96W	3X96
A Length	14.40"	15.75"
B Width	5.20"	6.62"
Depth	2.60"	4.95"

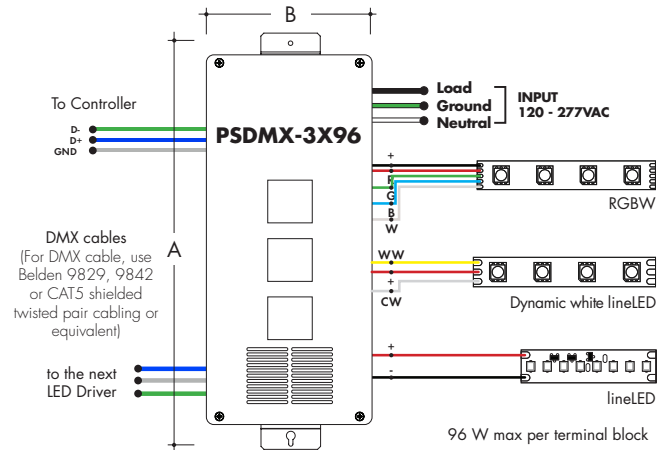
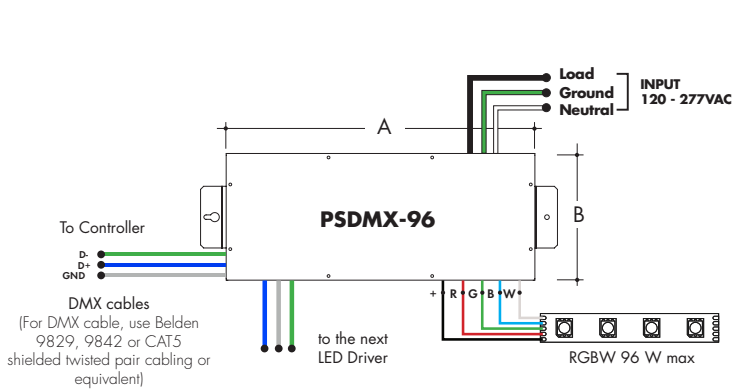

DMX-1Z-RGBW, DMX-3Z-RGBW

RGBW LED 1 or 3 Zone Controller

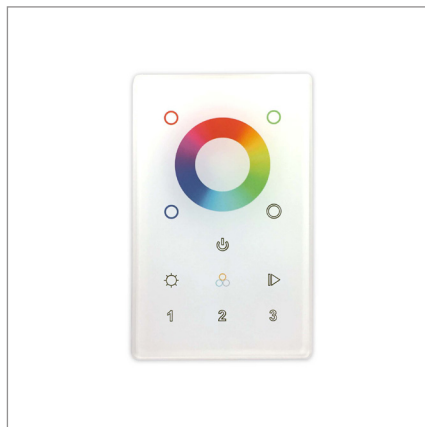

ORDERING CODE

MODEL	ZONES	COLOR
DMX - DMX Controller	3Z - Three Zone 1Z - One Zone	RGBW - Red, Green, Blue, & White

DMX /Wireless RGB-W wall-mount controller controls DMX lighting fixtures, wireless control of RGB-W lighting fixture or use both simultaneously. Fits in any standard US switch box. Includes all the outputs in the back of the controller.

Control brightness levels with a single touch, personalize and memorize 3 different scenes, and even create 3 variations of white.

Features

- 2 in 1 in-Wall Controller: DMX Control or Wireless RGB-W
- 65,000 Color Options, Dimming and Speed Control
- Memory Function
- 50 Foot Wireless Range
- Easily Fits Standard US Switch Boxes
- Touch Sensitive Glass Surface
- Includes 10 Built in Programs, or Create and Play Your Own

Operating Voltage

12 - 24V DC

Color Parameters

- Brightness
- Saturation
- Primary colors
- Fading
- Color changing speed

Touch DMX Controller

Touchscreen digital LED controller

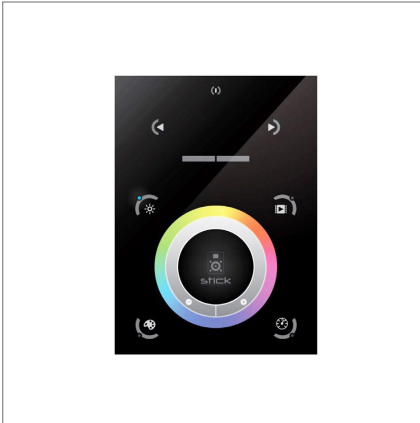

ORDERING CODE

MODEL

TSDMX-E

TSDMX-E - Touchscreen DMX controller

Programmable advanced DMX512 lighting controller featuring a touch-screen interface. Operates as stand alone controller or integrated with most architectural lighting control systems. Can control endless DMX512 enabled devices.

Mounts to standard single or dual gang wall box with the included power supply inside the junction box. Terminal block design for power and data connections.

Features

- Sleek glass design which sits 0.43" from the wall
- Graphical color display to show selected environment
- Color/dimmer/speed palette
- Color temperature mixing
- Touch sensitive buttons. No mechanical parts
- Touch sensitive wheel allows for accurate color selection
- Multi-zone microSD memory
- Multi-room control with 500 scenes, 10 zones
- 1024 DMX channels. Control 340 RGB fixtures
- USB & Ethernet connectivity for programming and control

Power Supply

7 VDC (included)

Programmability

PC, Mac, Tablet, Smartphone

Output Signal

DMX512 (1024 channels)

Color Parameters

- Brightness
- Saturation
- Speed of color changing sequence
- Fading / dimming / brightness

DMX Decoder

DMX signal to RGBW decoder (required to operate DMX controller)



ORDERING CODE

MODEL

DDMX-RGBW

DDMX-RGBW - DMX decoder

Translates controller DMX512 programs for RGB and white LED strips.

Unique DMX address for the decoder can be set easily and displayed by the numeric display on the case. Changing and resetting the DMX address requires manual input.

Use power repeater to expand output.

Operating Voltage

12-36 VDC

Power Capacity

up to 96W at 24V

Operating Temperature Range

from -4°F to +122°F in case