



Features

The High Efficacy (LLHE64) series is a small form factor high performance constant voltage LED strip. Designed to deliver best in class efficacy and output at over 1000 lumens/ft. Paired with Luminii extrusions for thermal control, this state-of-the-art high efficacy strip provides continuous dot-free illumination with its tight pitch.

Mounting

LED strip is equipped with 3M™ adhesive transfer tape (9472LE). LLHE64-XHO must be paired with an approved Luminii extrusion.

Applications

Indoor only - above and below cabinets, cove lighting, counter accent, architectural reveals, under banister, display and book cases, etc.

Approvals

Class 2 damp listed

Operating voltage

24 VDC

Life (L70)

50,000 hours

Warranty

5 years



Technical information

MODEL	LLHE64	
Output Options	VHO	XHO
LEDs/ft	64	64
Light output (3000K)	986 lm/ft	1073 lm/ft
Average power consumption (for 4' section)	7.5 W/ft	9.6 W/ft
Efficacy	126 lm/W	112 lm/W
Cutting increment	1.5"	
Pitch length	0.19"	
Maximum run length	15 ft	13 ft
Dimensions	0.48" W x 0.06" H	

CCT	Multiplier (referenced from 3000K)	TM-30			
		CRI	R _f	R _g	R ₉
2200K	0.73	92	91	97	42
2500K	0.81	93	96	96	62
2700K	0.94	92	90	99	58
3000K	1.00	92	89	99	57
3500K	1.02	92	89	99	60
4000K	1.02	92	86	94	71

SECTION START/END OPTIONS

No connector



Soldered lead wires (72")

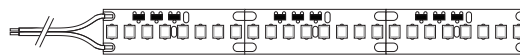

18 AWG

Lead Male 3" cable

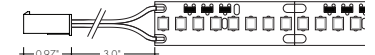

Lead Female 3" cable

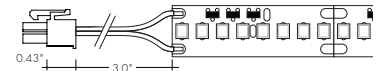

Ordering Code

MODEL	OUTPUT	CCT	SECTION START	SECTION END	LENGTH
LLHE64 - LLHE64	VHO - Very High XHO - Max	22K - 2200K 25K - 2500K 27K - 2700K 30K - 3000K 35K - 3500K 40K - 4000K	SL - Soldered lead wires (72") NC - No connector LM - Lead Male LF - Lead Female	SL - Soldered lead wires (72") NC - No connector LM - Lead Male LF - Lead Female	view table above for increment options and maximum run limits

Power Consumption

Per linear foot, tested at full power with PSD Series power supplies

Nominal Length	VHO		XHO	
	W/ft	Total wattage	W/ft	Total wattage
1	7.6	7.6	9.7	9.7
2	7.6	15.1	9.6	19.1
3	7.5	22.6	9.5	28.4
4	7.5	30.1	9.6	38.4
5	7.6	37.8	9.8	49.1
6	7.6	45.5	9.9	59.3
7	7.6	52.9	9.2	64.2
8	7.6	60.8	8.8	70.5
9	7.6	68.0	8.6	77.7
10	7.4	74.4	8.2	81.7
11	7.2	79.2	7.7	85.0
12	7.0	83.4	7.5	89.9
13	6.9	90.2	7.2	93.8
14	6.6	92.7		
15	6.3	95.2		

Accessories

CL1

Mounting clip recommended every 12" when LineLED strip is facing down

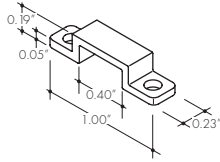

LVSP-4T-BK

Splice box for low voltage, 4 terminal connections, black

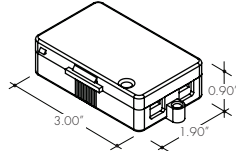

LL.ZIP

Strain relief clip for wire management

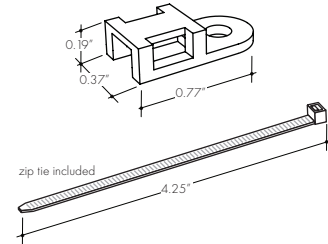

Lens Options / Light Transmission

C Clear **HF** Half (50%) Frosted **F** Frosted

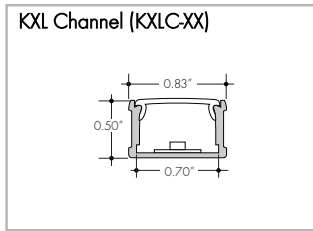

C 74% **F** 46% **HF** 61%

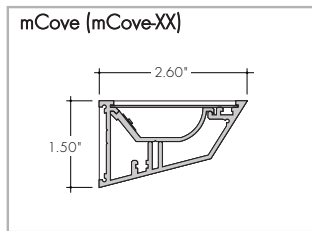

C 75%

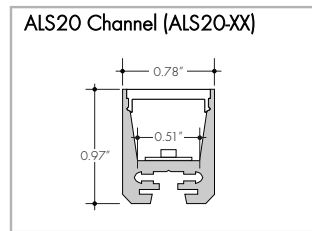

C 78% **F** 43%

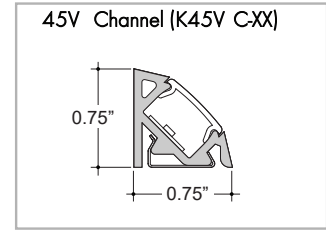

C 71% **F** 42% **HF** 58%

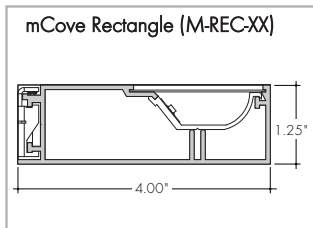

C 75%

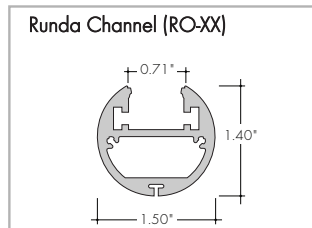

C 75%

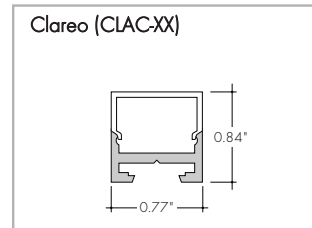

S Square Frosted 71% **Q** Rounded Square Frosted 71%

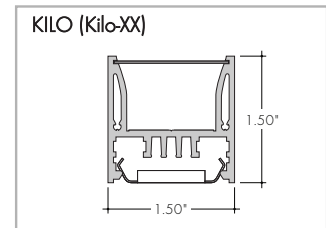

C 75% **F** 43%

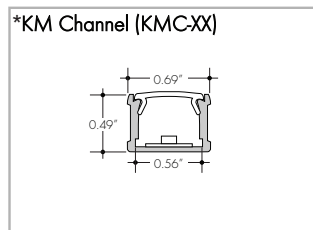

C 71% **F** 42% **HF** 58% **C10** 67% **R** 39%

Note: single row usage of LLHE64 only

*KMC is only compatible with LLHE64 - VHO

LED Dotting per extrusion

using the frosted lens option

extrusion	LED Model
KXLC, ALS20, K45VC	ND
mCove, mCove Rect	ND
RO	ND
CALC	ND
Kilo	ND
KMC	ND



Clear Dotting (**CD**) Slight Dotting (**SD**) NO Dotting (**ND**)

Installation

All mounting channels are field cuttable using miter saw with circular blade suitable for cutting aluminum.

Ordering

Extrusions are sold separately. View respective specsheets for details on ordering extrusions and their accessories (endcaps, mounting brackets, etc).

Power Supplies

See Power Supply instructions and spec sheet for wiring information. For a complete list of compatible dimmers, see Compatible Dimming Chart on the Resources page.

Universal Power Supply 1% 120VAC - 277VAC

MODEL	POWER	OUTPUT
PDCU-D - IP20 Dry Series	30 - 30 W 60 - 60 W 96 - 96 W 3X96 - 3X96 W	24 - 24 VDC
PDCU-W - IP66 Wet Series	96 - 96 W 3X96 - 3X96 W	

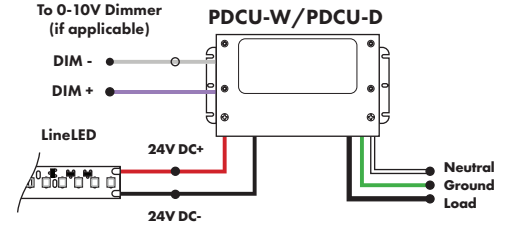

0-10V dims down to 1%, MLV/ELV/TRIAC dims down to 1%.
For a complete list of compatible dimmers, see [Compatible Dimming Chart](#) on the Resources page.

MODELS	PDCU-W 96W	PDCU-W 3X96W	PDCU-D 30W	PDCU-D 60W	PDCU-D 96W	PDCU-D 3X96W
Length	8.66"	11.85"	6.10"	7.93"	8.25"	9.57"
Width	3.73"	4.32"	3.35"	3.35"	4.10"	5.94"
Depth	1.61"	1.81"	1.33"	1.32"	1.56"	1.13"

0-10V Dimming Power Supplies 0.1% 120VAC - 277VAC

MODEL	POWER	OUTPUT	DIMMING
PS010V - 0-10V Power Supply dims down to 0.1%	96 - 96 Watt 3X96 - 3 X 96 Watt	24 - 24 VDC	LIN - Linear LOG - Logarithmic

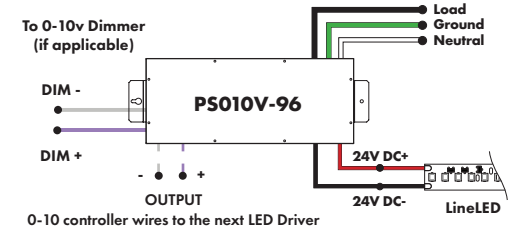

MODELS	96W	3X96
Length	14.40"	15.75"
Width	5.20"	6.62"
Depth	2.60"	4.95"

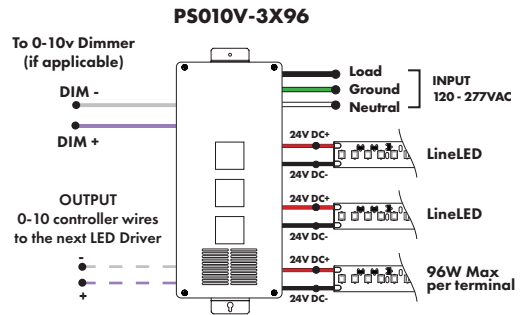

Triac, MLV, ELV, & PWM Compatible Dimmers

MODEL	POWER	OUTPUT
PDC - (IP20) Power Supply	96 - 96 Watts	24 - 24 VDC

MODELS	96W
Length	8.25"
Width	4.10"
Depth	1.56"

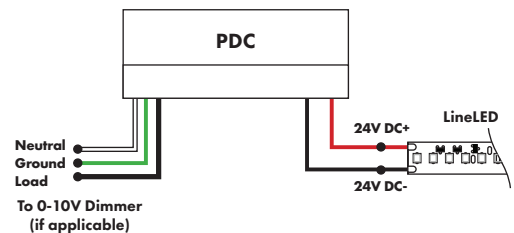

Power Supplies

See Power Supply instructions and spec sheet for wiring information. For a complete list of compatible dimmers, see Compatible Dimming Chart on the Resources page.

DMX Dimming Power Supplies 120VAC - 277VAC

MODEL	POWER	OUTPUT
PSDMX - DMX Power Supply dims down to 0%	96 - 96 Watt 3X96 - 3 X 96 Watt	24 - 24 VDC

Features eldoLED's LINEARdrive configurable dimmable drivers

MODELS	96W	3X96
Length	14.40"	15.75"
Width	5.20"	6.62"
Depth	2.60"	4.95"

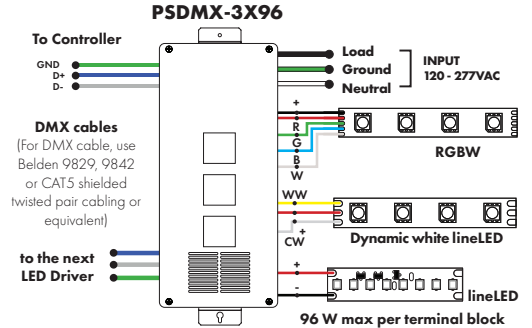
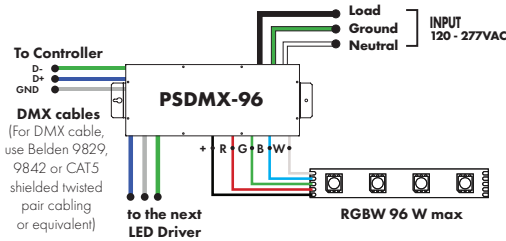

DALI 0% Dimming Power Supplies 120VAC - 277VAC

MODEL	POWER	OUTPUT
PSDALI - DALI Power Supply dims down to 0%	96 - 96 Watt 3X96 - 3 X 96 Watt	24 - 24 VDC

Features eldoLED's LINEARdrive configurable dimmable drivers

Model	96W	3X96
Length	14.40"	15.75"
Width	5.20"	6.62"
Depth	2.60"	4.95"

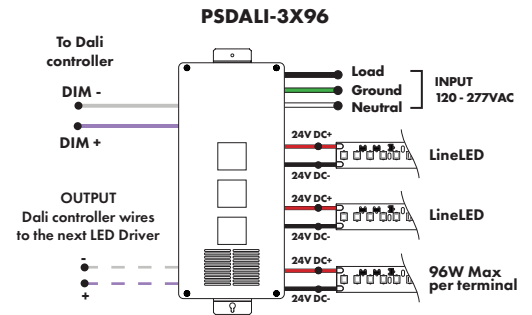
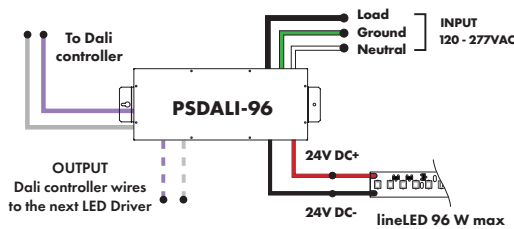

Enlighted Enabled Dimming Power Supplies 120VAC - 277VAC

MODEL	POWER	OUTPUT	DIMMING	LOCATION
PSV - PSV Series	96 - 96 Watt	24 - 24 VDC	ENL - Enlighted Dimming dims down to 0%	D - Damp

Model	96W
Length	14.40"
Width	5.20"
Depth	2.60"

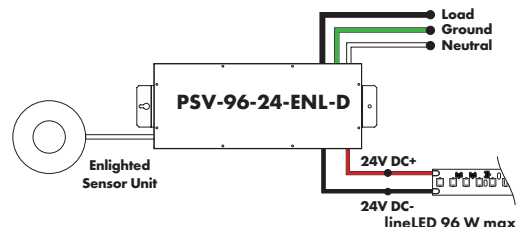

Power Supplies

See Power Supply instructions and spec sheet for wiring information. For a complete list of compatible dimmers, see Compatible Dimming Chart on the Resources page.

Non-Dimming Power Supply 120VAC - 277VAC

MODEL	POWER	OUTPUT	DIMMING	LOCATION
PSV - PSV Series	96 - 96 Watt	24 - 24 VDC	U2ND - Non Dimming	D - Damp

MODELS	96W
Length	14.40"
Width	5.20"
Depth	2.60"

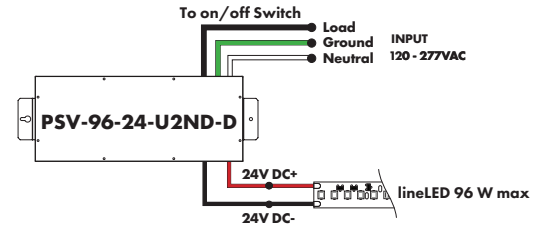

Luminii is a Lutron OEM Advantage Partner

Lutron Power Supplies 1%

MODEL	MODEL
LTEA4U1UKL-CV240	L3DA4U1UKL-CV240
Lutron - HiLume™ 1% 2-wire LED Driver 40W max	HiLume™ 1% EcoSystem Voltage LED driver 40W max
(120V forward phase only)	

MODELS	LTEA4U1UKL-CV240	L3DA4U1UKL-CV240
Length	4.89"	4.98"
Width	4.00"	4.00"
Depth	2.62"	2.62"

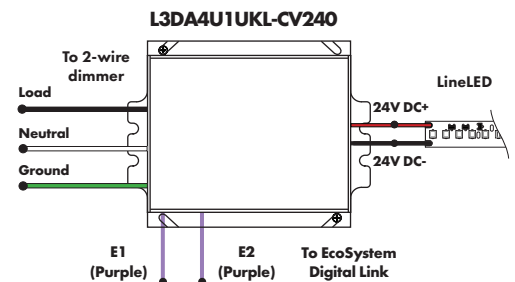
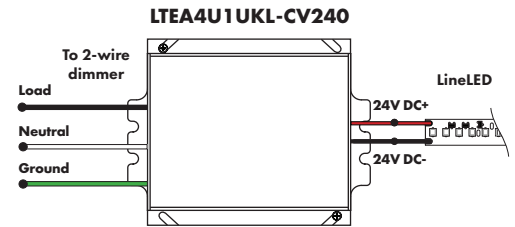

Luminii is a Lutron OEM Advantage Partner

Lutron Power Supplies 0.1%

MODEL
L3D0-96W24V-U
HiLume™ 0.1% EcoSystem Voltage LED Driver with Soft-On, Fade-to-Black™ 96W max

MODELS	L3D0
Length	10.50"
Width	5.50"
Depth	2.00"

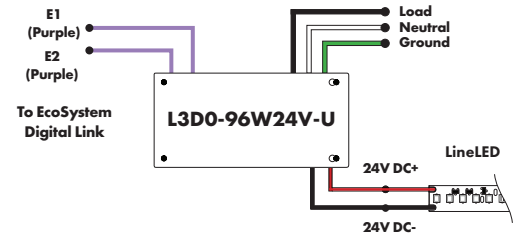

In-Ground Power Supplies

MODEL	POWER	OUTPUT	INPUT
IG - In ground CVE Series	CVE - ELV Dimming DALI - eidoLED Dali dimming Both dims down to 0%	96X2 - 2 X 96 Watt	24 - 24 VDC
			Blank - 120 V 277 - 240/277 V

MODELS	Dual Circuit
Length	8.40"
Width	8.30"
Depth	8.10"

