



The High Efficacy (LLHE48) Wet Tube series is a small form factor high performance constant voltage LED strip. Designed to deliver best in class efficacy while operating at low temperature, LLHE48 Wet Tube delivers constant light output, outstanding color consistency and dimming performance without the need of an additional heat sink. Available in 3 different outputs with a tight LED pitch of 0.25", LLHE48 Wet Tube offers a clean dot free illumination in most Luminii profiles when paired with our frosted lenses.

To maintain IP65, IP67, and IP68 rating, LLHE48 Wet Tube is factory sealed and bonded. Order in exact lengths required for install, LineLED Wet Tube is not field cuttable. IP rating of strip is equal to the lowest IP rating of section start and end options.

Applications: outdoor / wet location, above cabinet, cove lighting, counter accent, architectural accents, under banisters, decks, gazebos, barbeque stations and wet bars.

**Mounting**  
LED strip is equipped with 3M™ VHB™ adhesive transfer tape.

**Approvals**  
IP65, IP67, and IP68 rated

**Operating Environment Temperature**  
-30°C (-22°F) to 50°C (122°F)

**Operating voltage**  
24 VDC

**Lumen Maintenance:**  
Calculated L90 at 173,000 hours for High Output

**Warranty**  
3 years



Technical information

MODEL	LO	SO	MO
LEDS/ft	48	48	48
Light output 3000K	231 lum/ft	330 lum/ft	441 lum/ft
Average power consumption (for 4' section)	1.9 W/ft	2.8 W/ft	3.5 W/ft
Ordering increment	1.97	1.97	1.97
Efficacy lum/watt	122 lm/W	118 lm/W	126 lm/W
Maximum run length (in series)	48 ft	42 ft	33ft

Dimensions 0.53"W x 0.24" H

Color Temperature	Multiplier (referenced from 3000K)	CRI	R <sub>f</sub>	R <sub>g</sub>	R <sub>9</sub>
2700K	0.94	92	90	99	58
3000K	1.00	92	89	99	57
3500K	1.02	92	89	99	60
4000K	1.02	92	86	94	71

SECTION START/END OPTIONS

**SL65**

72" Soldered Leads, IP65 rated

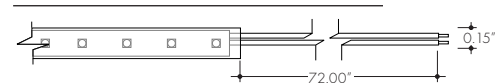

**SL68**

72" Soldered Leads, IP68 rated

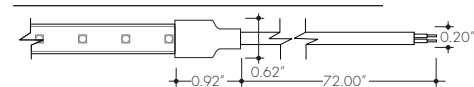

**F**

Female Quick Connect End, IP67 rated

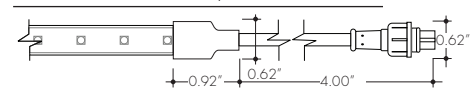

**M**

Male Quick Connect End, IP67 rated

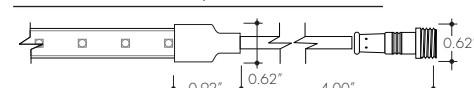

**NC**

No Connector

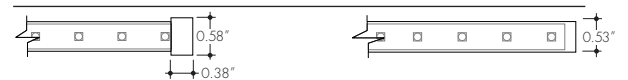

IP68 rated when used with SL68 selection

IP65 rated when used with SL65 selection  
IP67 rated when used with M or F selection

Ordering code

MODEL	ENCLOSURE	OUTPUT <sup>1</sup>	CCT	SECTION START	SECTION END <sup>2</sup>	LENGTH
LLHE48WET	T - Tube	LO - Low SO - Standard MO - Medium	27K - 2700K 30K - 3000K 35K - 3500K 40K - 4000K	SL65 - IP65 Soldered lead wires (72") SL68 - IP68 Soldered lead wires (72") F - IP67 Female Quick Connect M - IP67 Male Quick Connect NC - No Connector	SL65 - IP65 Soldered lead wires (72") SL68 - IP68 Soldered lead wires (72") F - IP67 Female Quick Connect M - IP67 Male Quick Connect NC - No Connector	2" increments

1 - All outputs and CCTs combination be used to comply with Title 24 JAB.

2 - IP rating of strip is equal to the lowest IP rating of section and start end options.

Power consumption per linear foot - loads tested with PSD series

Accessories

LLHE48WET

Length of Strip (LF)	LO		SO		MO	
	W/ft	Total wattage	W/ft	Total wattage	W/ft	Total wattage
1	1.7	1.7	2.5	2.5	3.5	3.5
2	1.9	3.7	2.7	5.4	3.5	7.0
3	2.0	5.7	2.8	8.2	3.5	10.2
4	1.8	7.1	2.8	11.2	3.5	13.9
5	1.8	9.0	3.0	14.6	3.6	17.6
6	1.9	11.3	2.9	17.9	3.5	21.4
7	1.8	13.1	2.9	20.8	3.5	25.1
8	1.8	14.7	2.9	23.3	3.6	28.5
9	1.8	16.4	2.9	25.9	3.5	31.9
10	1.8	18.1	2.9	28.6	3.5	35.5
11	1.7	19.1	2.8	31.2	3.5	38.9
12	1.7	20.4	2.9	34.4	3.5	42.3
13	1.7	22.1	2.8	36.8	3.5	45.7
14	1.6	22.8	2.8	39.3	3.5	48.8
15	1.6	23.5	2.8	41.9	3.5	52.1
16	1.6	25.6	2.8	45.3	3.5	56.5
17	1.7	28.5	2.8	48.1	3.5	59.4
18	1.7	30.4	2.8	51.0	3.5	62.8
19	1.8	33.6	2.8	53.3	3.5	65.8
20	1.8	35.8	2.8	56.0	3.5	69.0
21	1.8	37.7	2.8	59.4	3.4	71.4
22	1.8	39.5	2.8	61.3	3.3	73.5
23	1.8	41.4	2.8	64.4	3.3	75.4
24	1.8	43.1	2.8	66.0	3.2	77.2
25	1.9	46.2	2.7	68.1	3.2	78.8
26	1.9	48.2	2.7	70.7	3.1	79.8
27	1.9	50.4	2.7	72.0	3.0	81.4
28	1.9	52.2	2.6	73.6	3.0	82.9
29	1.9	53.9	2.6	74.7	2.9	84.2
30	1.9	57.7	2.5	76.1	2.9	86.1
31	1.9	59.6	2.5	77.0	2.8	87.6
32	1.9	61.4	2.4	77.7	2.8	89.2
33	1.9	63.3	2.4	78.9	2.7	90.7
34	1.9	65.0	2.3	78.0		
35	1.9	65.4	2.2	78.1		
36	1.9	67.1	2.2	79.5		
37	1.9	69.3	2.2	80.4		
38	1.9	71.1	2.1	80.9		
39	1.9	73.0	2.1	81.0		
40	1.9	74.7	2.0	81.2		
41	1.9	76.0	2.0	82.6		
42	1.8	77.3	2.0	83.0		
43	1.8	78.6				
44	1.8	79.9				
45	1.8	81.1				
46	1.8	81.8				
47	1.8	82.5				
48	1.7	83.1				

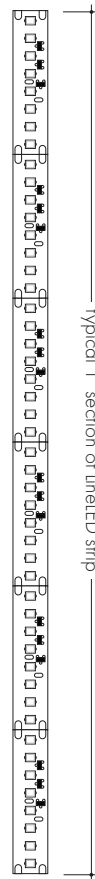

Mounting clip:  
recommended at every 12" when  
LineLED strip is facing down.

Part # CL-2

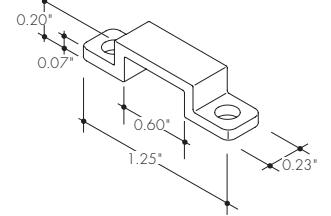

Splice Box:  
Wet rated, low voltage  
splice box, gray

Part # LVSP-WET

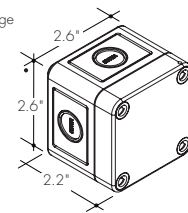

Connector:  
Low voltage splice box wet cable  
management gray

Part # LVSP-WET-CM

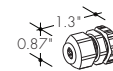

Male/Female Joiner:  
linking and extension cable in 12" or 48"

Part # IP68-12  
IP68-48

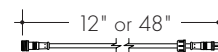

Lens options / light transmission percentage per lens

- C** Clear
- HF** Half (50%) Frosted
- G** Graze
- SI** Satin Ice
- S** Square Frosted
- Q** Rounded Square Frosted
- F** Frosted
- M** Medium beam frosted
- R** Raised
- C36** Clear 36° beam angle
- C10** Clear 10° beam angle

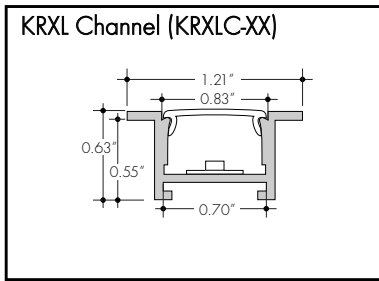

- C**  
74%
- F**  
46%
- HF**  
61%

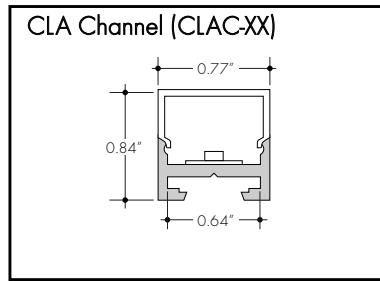

- S**  
62%
- Q**  
63%

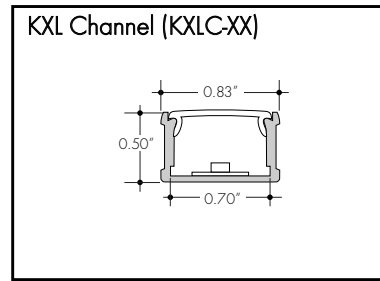

- C**  
74%
- F**  
46%
- HF**  
61%

\*Not compatible with IP68 connectors

**Installation**

All mounting channels are field cuttable using miter saw with circular blade suitable for cutting aluminum.

**Ordering**

Extrusions are sold separately. View respective specsheets for details on ordering extrusions and their accessories (endcaps, mounting brackets, etc).

**Discontinued Extrusion Reference Link**

<https://www.luminii.com/media/4351/extrusion-update-02.pdf>

**LED Dotting per extrusion**

using the frosted lens option

extrusion	LED Model
KXLC, KRXLC	LLHE48WET
KLC, KRLC	ND
CLAC	ND



Clear Dotting (CD)      Slight Dotting (SD)      NO Dotting (ND)

## Power Supplies

See Power Supply instructions and spec sheet for wiring information. For a complete list of compatible dimmers, see Compatible Dimming Chart on the Resources page.

### Universal Power Supply 1% 120VAC - 277VAC

MODEL	POWER	OUTPUT
PDCU-D - IP20 Dry Series	30 - 30 W 60 - 60 W 96 - 96 W 3X96 - 3X96 W	24 - 24 VDC
PDCU-W - IP66 Wet Series	96 - 96 W 3X96 - 3X96 W	

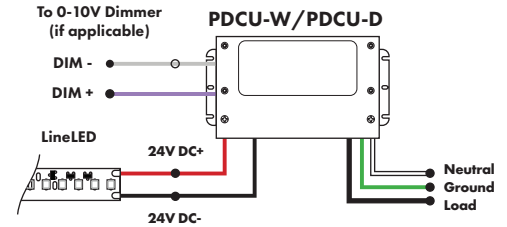

0-10V dims down to 1%, MLV/ELV/TRIAC dims down to 1%.  
For a complete list of compatible dimmers, see [Compatible Dimming Chart](#) on the Resources page.

MODELS	PDCU-W 96W	PDCU-W 3X96W	PDCU-D 30W	PDCU-D 60W	PDCU-D 96W	PDCU-D 3X96W
<b>Length</b>	8.66"	11.85"	6.10"	7.93"	8.25"	9.57"
<b>Width</b>	3.73"	4.32"	3.35"	3.35"	4.10"	5.94"
<b>Depth</b>	1.61"	1.81"	1.33"	1.32"	1.56"	1.13"

### 0-10V Dimming Power Supplies 0.1% 120VAC - 277VAC

MODEL	POWER	OUTPUT	DIMMING
PS010V - 0-10V Power Supply dims down to 0.1%	96 - 96 Watt 3X96 - 3 X 96 Watt	24 - 24 VDC	LIN - Linear LOG - Logarithmic

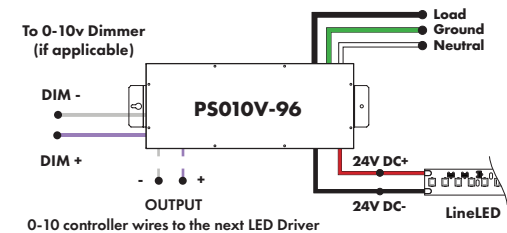

MODELS	96W	3X96
<b>Length</b>	14.40"	15.75"
<b>Width</b>	5.20"	6.62"
<b>Depth</b>	2.60"	4.95"

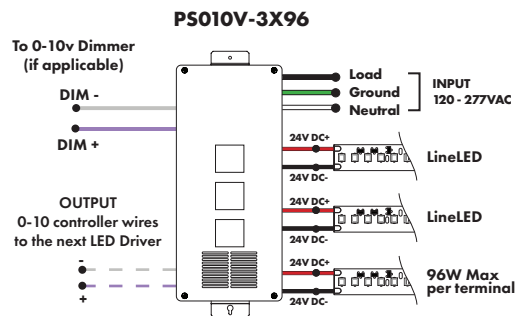

### Triac, MLV, ELV, & PWM Compatible Dimmers

MODEL	POWER	OUTPUT
PDC - (IP20) Power Supply	96 - 96 Watts	24 - 24 VDC

MODELS	96W
<b>Length</b>	8.25"
<b>Width</b>	4.10"
<b>Depth</b>	1.56"

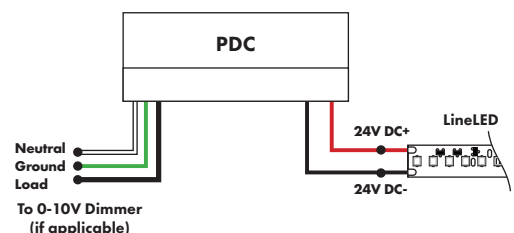

**Power Supplies**

See Power Supply instructions and spec sheet for wiring information. For a complete list of compatible dimmers, see Compatible Dimming Chart on the Resources page.

**DMX Dimming Power Supplies 120VAC - 277VAC**

MODEL	POWER	OUTPUT
PSDMX - DMX Power Supply dims down to 0%	96 - 96 Watt 3X96 - 3 X 96 Watt	24 - 24 VDC

Features eldoLED's LINEARdrive configurable dimmable drivers

MODELS	96W	3X96
<b>Length</b>	14.40"	15.75"
<b>Width</b>	5.20"	6.62"
<b>Depth</b>	2.60"	4.95"

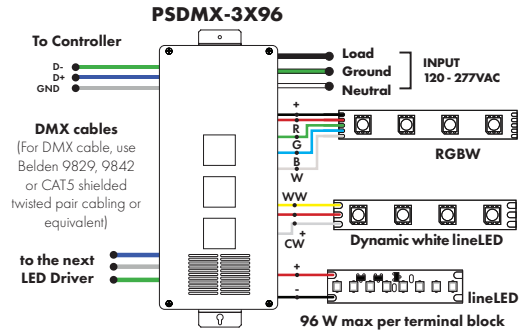
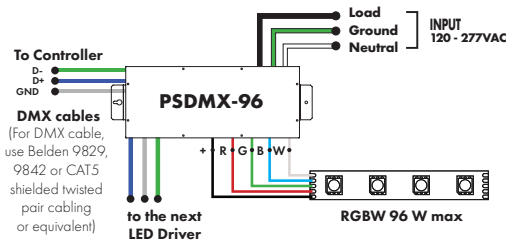

**DALI 0% Dimming Power Supplies 120VAC - 277VAC**

MODEL	POWER	OUTPUT
PSDALI - DALI Power Supply dims down to 0%	96 - 96 Watt 3X96 - 3 X 96 Watt	24 - 24 VDC

Features eldoLED's LINEARdrive configurable dimmable drivers

Model	96W	3X96
<b>Length</b>	14.40"	15.75"
<b>Width</b>	5.20"	6.62"
<b>Depth</b>	2.60"	4.95"

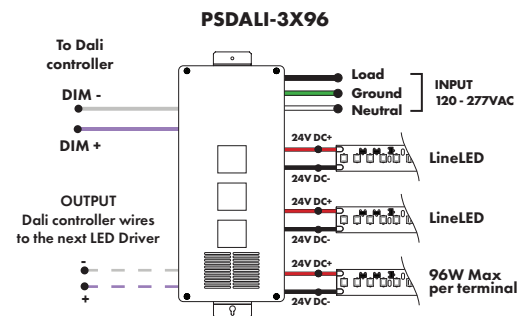
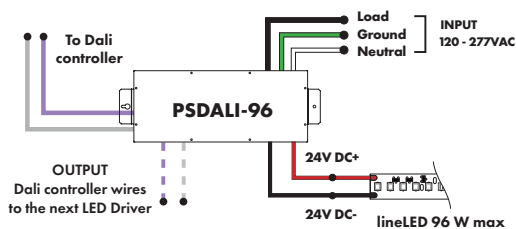

**Enlighted Enabled Dimming Power Supplies 120VAC - 277VAC**

MODEL	POWER	OUTPUT	DIMMING	LOCATION
PSV - PSV Series	96 - 96 Watt	24 - 24 VDC	ENL - Enlighted Dimming dims down to 0%	D - Damp

Model	96W
<b>Length</b>	14.40"
<b>Width</b>	5.20"
<b>Depth</b>	2.60"

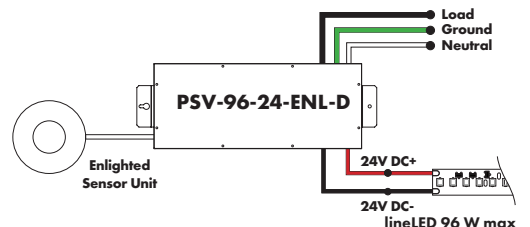

**Power Supplies**

See Power Supply instructions and spec sheet for wiring information. For a complete list of compatible dimmers, see Compatible Dimming Chart on the Resources page.

**Non-Dimming Power Supply 120VAC - 277VAC**

MODEL	POWER	OUTPUT	DIMMING	LOCATION
PSV - PSV Series	96 - 96 Watt	24 - 24 VDC	U2ND - Non Dimming	D - Damp

MODELS	96W
<b>Length</b>	14.40"
<b>Width</b>	5.20"
<b>Depth</b>	2.60"

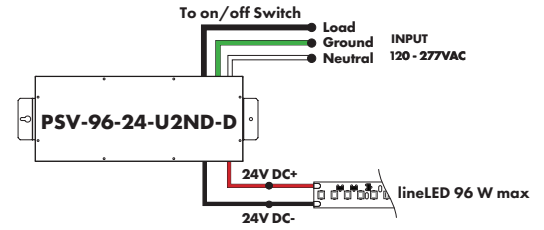

Luminii is a Lutron OEM Advantage Partner

**Lutron Power Supplies 1%**

MODEL	MODEL
<b>LTEA4U1UKL-CV240</b>	<b>L3DA4U1UKL-CV240</b>
Lutron - HiLume™ 1% 2-wire LED Driver 40W max	HiLume™ 1% EcoSystem Voltage LED driver 40W max
(120V forward phase only)	

MODELS	LTEA4U1UKL-CV240	L3DA4U1UKL-CV240
<b>Length</b>	4.89"	4.98"
<b>Width</b>	4.00"	4.00"
<b>Depth</b>	2.62"	2.62"

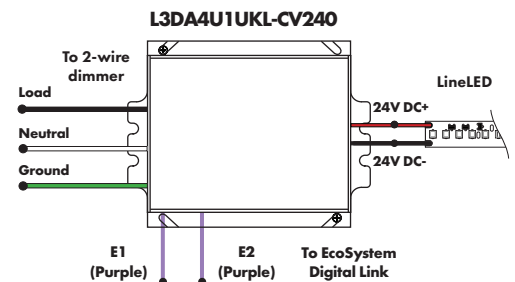
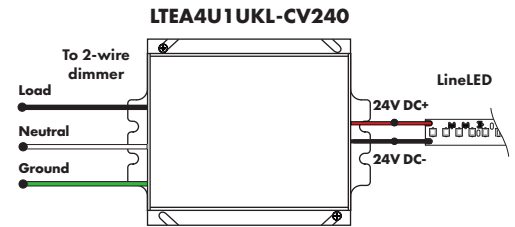

Luminii is a Lutron OEM Advantage Partner

**Lutron Power Supplies 0.1%**

MODEL
<b>L3D0-96W24V-U</b>
HiLume™ 0.1% EcoSystem Voltage LED Driver with Soft-On, Fade-to-Black™ 96W max

MODELS	L3D0
<b>Length</b>	10.50"
<b>Width</b>	5.50"
<b>Depth</b>	2.00"

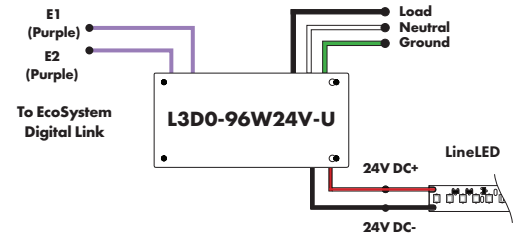

**In-Ground Power Supplies**

MODEL	POWER	OUTPUT	INPUT
IG - In ground CVE Series	CVE - ELV Dimming DALI - eidoLED Dali dimming Both dims down to 0%	96X2 - 2 X 96 Watt	24 - 24 VDC
			Blank - 120 V 277 - 240/277 V

MODELS	Dual Circuit
<b>Length</b>	8.40"
<b>Width</b>	8.30"
<b>Depth</b>	8.10"

