

LineLED 24V - Installation Instructions

Models LLDW52-

Please read all instructions prior to installation and keep for future reference!

1. Product should be installed by a qualified electrician.
2. Prior to installation ensure power is off at fuse box to prevent electrical shock.
3. Use only with Class 2 power unit. *Utiliser seulement avec Classe 2 unite d'alimentation electrique.*
4. Suitable for Damp Locations. *Convient Aux Emplacements Humides.*
5. For under-cabinet or shelf mount.



Page 1 of 3

Attention: Always test LineLED operation before installing.
Connect LineLED to power supply to ensure it is working properly and no damage has occurred during shipping.

1 Clean the area thoroughly where the LineLED will be installed.

Remove the paper backing from the LineLED and firmly press down making sure there are no air bubbles that can cause surface irregularities. **Do not remove the adhesive, removing the adhesive may cause arcing of the Line LED tape.**

NOTE - When removing backing & laying LineLED to surface avoid installing with ripples & bending over 90°.

NOTE - Avoid bending near 1" on both side of the soldered joints.

2 If length of LineLED needs to be adjusted on site, simply cut the LED strip in between solder pads. Always cut from end with no wire leads.

3 Always ensure power to power supply is off! Follow diagrams on page 2 to connect power feed wires to power supply.

LineLED 24V - Installation Instructions

Models LLDW52-

Please read all instructions prior to installation and keep for future reference!

1. Product should be installed by a qualified electrician.
2. Prior to installation ensure power is off at fuse box to prevent electrical shock.
3. Use only with Class 2 power unit. *Utiliser seulement avec Classe 2 unite d'alimentation electrique.*
4. Suitable for Damp Locations. *Convient Aux Emplacements Humides.*
5. For under-cabinet or shelf mount.



Page 2 of 3

Wiring Diagrams

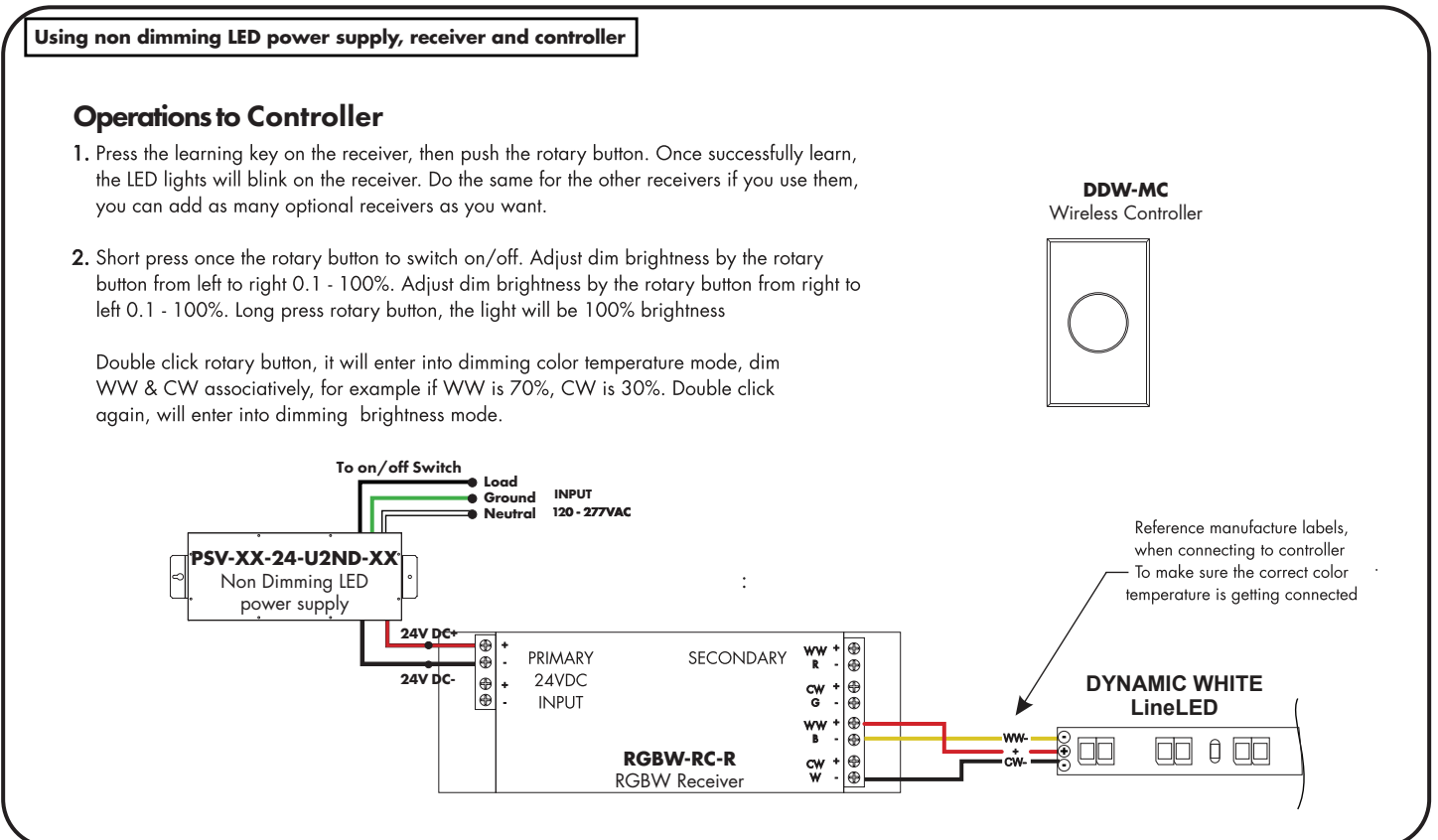
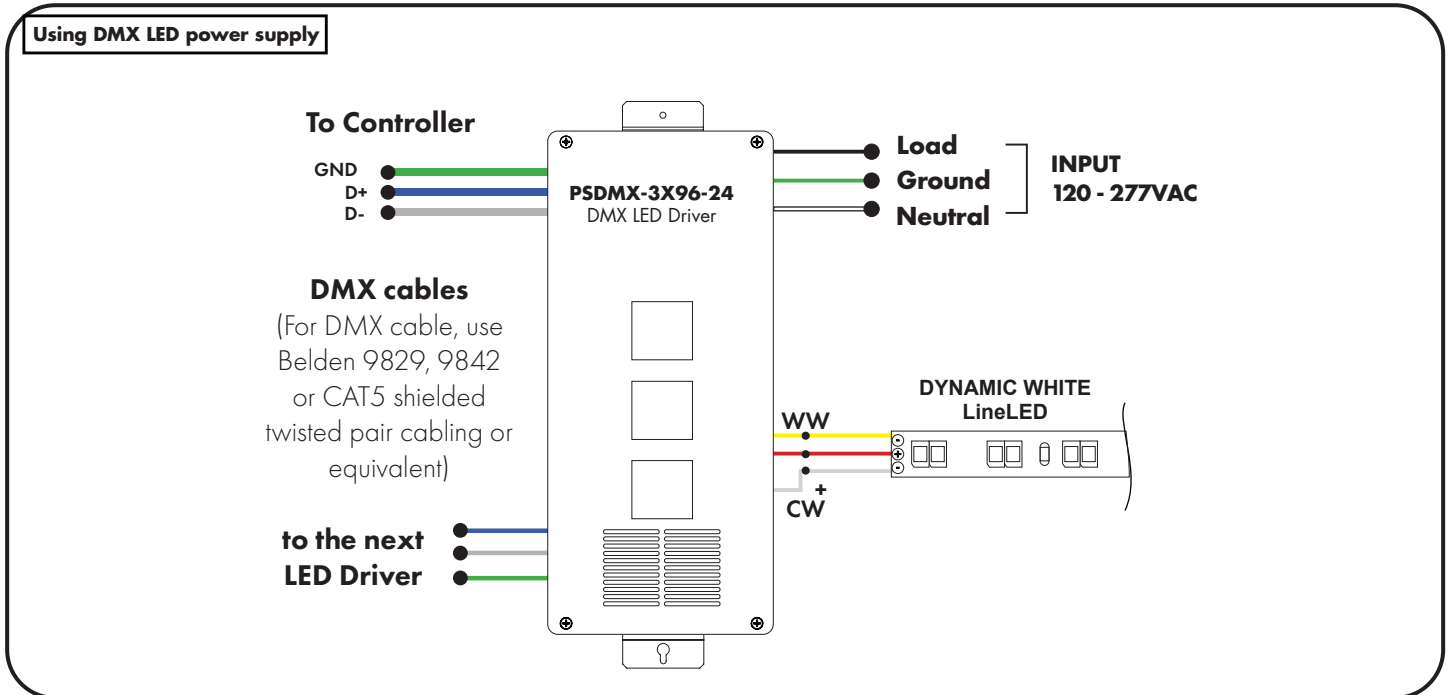

LineLED 24V - Installation Instructions

Models LLDW52-

Please read all instructions prior to installation and keep for future reference!

1. Product should be installed by a qualified electrician.
2. Prior to installation ensure power is off at fuse box to prevent electrical shock.
3. Use only with Class 2 power unit. *Utiliser seulement avec Classe 2 unite d'alimentation electrique.*
4. Suitable for Damp Locations. *Convient Aux Emplacements Humides.*
5. For under-cabinet or shelf mount.



Page 3 of 3

Using warm dim LED power supply

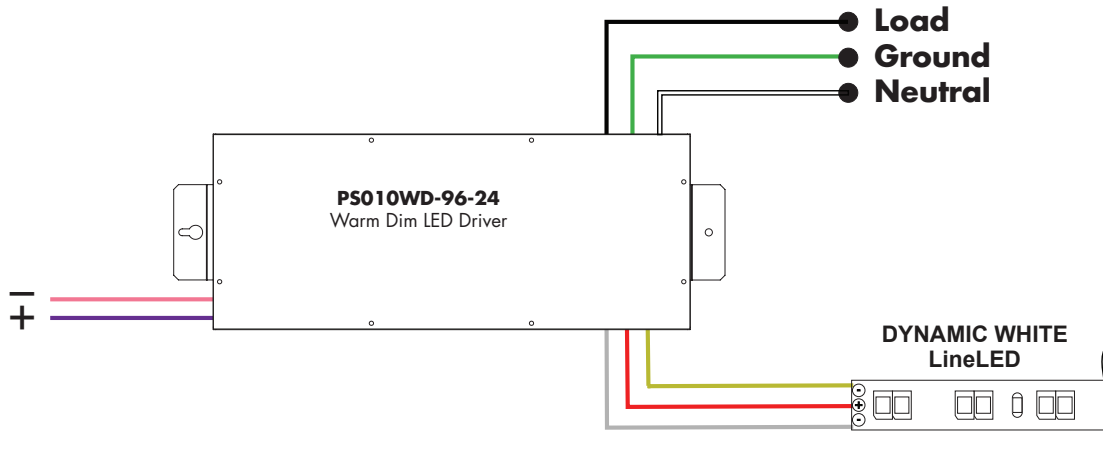

Using tunable white LED power supply

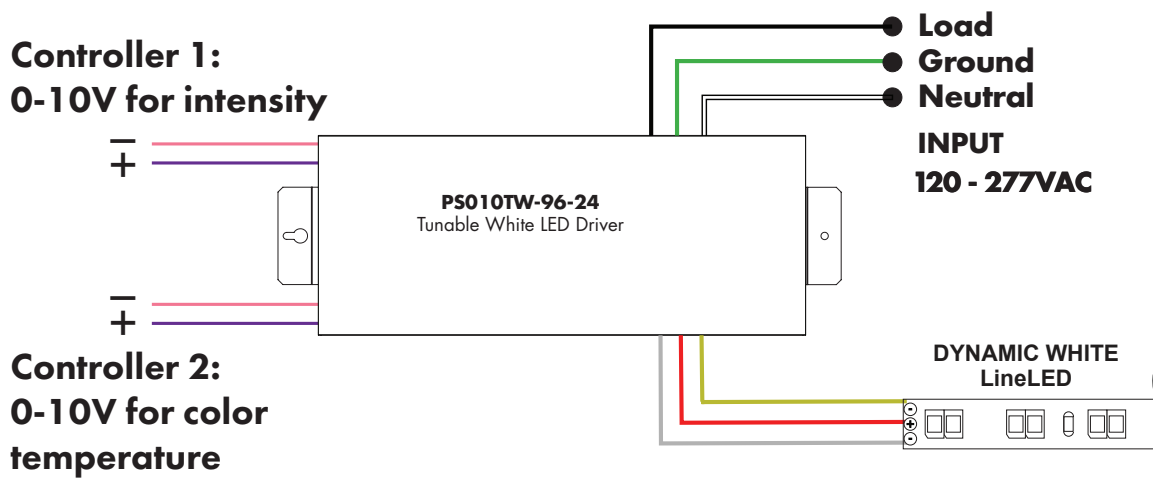

LineLED 24V - Installation Instructions

Models LLDW52-

Please read all instructions prior to installation and keep for future reference!

1. Product should be installed by a qualified electrician.
2. Prior to installation ensure power is off at fuse box to prevent electrical shock.
3. Use only with Class 2 power unit. *Utiliser seulement avec Classe 2 unite d'alimentation electrique.*
4. Suitable for Damp Locations. *Convient Aux Emplacements Humides.*
5. For under-cabinet or shelf mount.



Page 4 of 3

Using non dimming LED power supply, decoder and controller

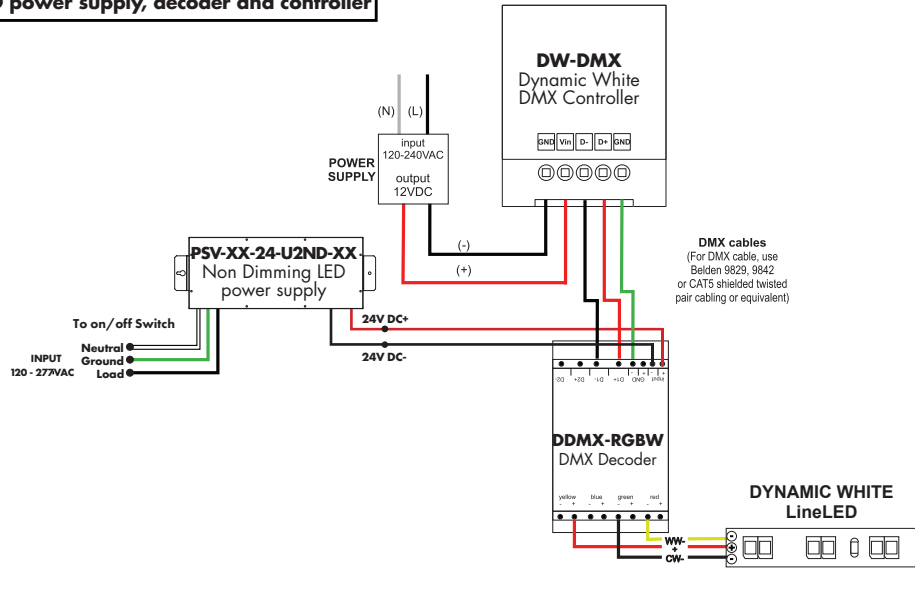

Using non dimming LED power supply and decoder

