



Features

LineLED Wet Tube is a small profile, energy efficient LED strip for IP65, IP67, and IP68 rated wet installations. LineLED Wet Tube offers excellent color quality with CRI and R9 values up to 97 as well as multiple output options and a wide angle 120° beam. With a durable but flexible circuit board, LineLED Wet Tube is also easy to install.

To maintain IP65, IP67, and IP68 rating, LineLED Wet Tube is factory sealed and bonded. Order in exact lengths required for install, LineLED Wet Tube is not field cuttable. IP rating of strip is equal to the lowest IP rating of section start and end options.

Mounting

LED strip is equipped with 3M™ adhesive transfer tape (9472LE).

Applications

Outdoor and wet locations - cove lighting, architectural accent, handrail, wet bars

Approvals

IP65, IP67, and IP68 rated

Operating voltage

24 VDC

Life (L70)

50,000 hours

Warranty

3 years



Technical information

Model	LL42 WET		
Output Options	SO	HO	VHO
Light Output (3000K)	120 lm/ft	200 lm/ft	290 lm/ft
Average Power Consumption (for a 4' section)	1.4 W/ft	2.4 W/ft	3.6 W/ft
Efficacy	93 lm/W	94 lm/W	88 lm/W
Cutting Increment (in)	1.97"		
Pitch Length	0.28"		
Max Run Length (in series)	55 ft	45 ft	35 ft
Dimensions	0.47"W x 0.24" H		

CCT	Multiplier (reference - 3000K)	CRI	TM-30		
			R _f	R _g	R ₉
2700K	0.74	97	96	101	91
3000K	1.00	97	95	104	97
3500K	1.02	97	94	105	97
4100K	1.07	97	90	99	97

SECTION START/END OPTIONS

SL65

72" Soldered Leads, IP65 rated

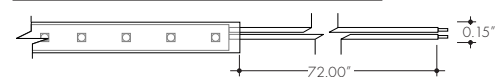

SL68

72" Soldered Leads, IP68 rated

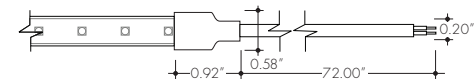

F

Female Quick Connect End, IP67 rated

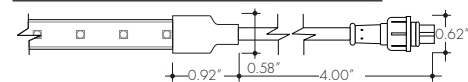

M

Male Quick Connect End, IP67 rated

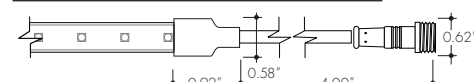

NC

No Connector



IP68 rated when used with SL68 selection
IP67 rated when used with M or F selection

IP65 rated when used with SL65 selection

Ordering code

MODEL	ENCLOSURE	OUTPUT ¹	CCT	SECTION START ²	SECTION END ²	LENGTH
LL42WET-LineLED LL42 Wet	T-Tube	SO-Standard HO-High VHO-Very High	27K-2700K 30K-3000K 35K-3500K 41K-4100K	SL65-IP65 Soldered lead wires (72") SL68-IP68 Soldered lead wires (72") F-IP67 Female Quick Connect M-IP67 Male Quick Connect NC-No Connector	SL65-IP65 Soldered lead wires (72") SL68-IP68 Soldered lead wires (72") F-IP67 Female Quick Connect M-IP67 Male Quick Connect NC-No Connector	view table above for order increment options and maximum run length

1 - All outputs and CCTs combination be used to comply Title 24 JA8.

2 - IP rating of strip is equal to the lowest IP rating of section start and end options.

Accessories

LVSP-WET

Splice box: wet rated, low voltage, gray

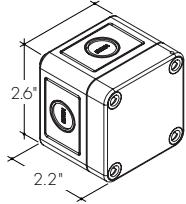

LVSP-WET-CM

Connector for splice box, low voltage for cable management, gray.

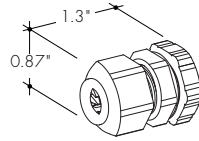

CL2

Mounting clip recommended every 12" when LineLED strip is facing down

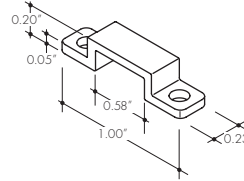

LL.ZIP

Strain relief clip for wire management

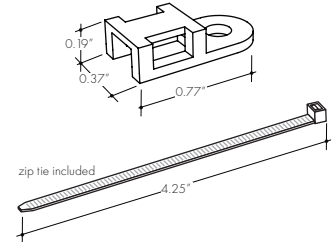

Lens Options / Light Transmission

- C**
Clear
- HF**
Half (50%)
Frosted
- G**
Graze
- SI**
Satin Ice
- S**
Square
Frosted
- Q**
Round Square
Frosted
- F**
Frosted
- M**
Medium Beam
Frosted
- R**
Raised
- C36**
Clear 36°
Beam Angle
- C10**
Clear 10°
Beam Angle

<p>KM Channel (KMC-XX)</p> <p>C 71% F 42% HF 58% C10 67% R 39%</p>	<p>K45V Channel (K45VC-XX)</p> <p>C 71% F 42% HF 58% C10 67%</p>	<p>K45R Channel (K45RC-XX)</p> <p>F 42%</p>	<p>KXL Channel (KXLC-XX)</p> <p>C 74% F 46% HF 61%</p>	<p>CLA Channel (CLAC-XX)</p> <p>S 62% Q 63%</p>
<p>KRM Channel (KRMC-XX)</p> <p>C 71% F 42% HF 58%</p>	<p>KRXL Channel (KRXLC-XX)</p> <p>C 74% F 46% HF 61%</p>	<p>ALS20 Channel (ALS20-XX)</p> <p>C 78% F 43%</p>		

Installation

All mounting channels are field cuttable using miter saw with circular blade suitable for cutting aluminum.

Ordering

Extrusions are sold separately. View respective specsheets for details on ordering extrusions and their accessories (endcaps, mounting brackets, etc).

LED Dotting per extrusion

using the frosted lens option

Extrusion	LL42
KMC, KRMC, K45VC, K45RC	ND
KXLC, KRXLC	ND
ALS20	ND
CLAC	ND



Power Consumption

Per linear foot, tested at full power with PSD Series power supplies

Nominal Length	LL42											
	SO		HO		VHO		SO		HO		VHO	
	W/ft	Total wattage	W/ft	Total wattage	W/ft	Total wattage	W/ft	Total wattage	W/ft	Total wattage	W/ft	Total wattage
1	1.2	1.2	2.2	2.2	3.2	3.2	37	1.2	44.0	1.8	66.3	
2	1.2	2.4	2.5	4.9	3.2	6.4	38	1.2	44.8	1.8	67.4	
3	1.4	4.2	2.4	7.2	3.5	10.4	39	1.2	45.7	1.8	68.4	
4	1.4	5.4	2.4	9.4	3.6	14.4	40	1.2	46.6	1.7	69.4	
5	1.4	7.2	2.3	11.5	3.6	18.1	41	1.2	47.3	1.7	70.3	
6	1.4	8.6	2.3	13.6	3.6	21.3	42	1.1	48.0	1.7	71.3	
7	1.4	9.9	2.3	15.9	3.6	25.3	43	1.1	48.8	1.7	72.2	
8	1.4	11.1	2.3	18.1	3.6	28.9	44	1.1	49.5	1.7	73.2	
9	1.4	12.4	2.3	20.3	3.5	31.6	45	1.1	50.2	1.6	74.1	
10	1.4	13.9	2.3	23.0	3.5	34.7	46	1.1	50.9			
11	1.4	15.4	2.3	25.0	3.4	37.3	47	1.1	51.6			
12	1.4	16.4	2.3	27.2	3.3	40.0	48	1.1	52.4			
13	1.4	17.9	2.2	29.1	3.3	42.7	49	1.1	53.1			
14	1.4	19.1	2.2	31.1	3.3	45.6	50	1.1	53.8			
15	1.4	20.3	2.2	32.6	3.2	48.2	51	1.1	54.4			
16	1.4	21.6	2.2	35.0	3.2	51.1	52	1.1	55.0			
17	1.3	22.6	2.1	36.5	3.1	53.5	53	1.1	55.7			
18	1.3	23.8	2.1	37.9	3.1	55.6	54	1.0	56.3			
19	1.3	25.0	2.1	39.8	3.1	58.1	55	1.0	56.9			
20	1.3	26.5	2.2	43.4	3.0	60.1						
21	1.3	27.5	2.1	45.0	3.0	62.3						
22	1.3	28.8	2.1	46.6	2.9	64.6						
23	1.3	30.0	2.1	48.2	2.9	67.0						
24	1.3	31.3	2.1	49.8	2.9	69.3						
25	1.3	32.5	2.1	51.4	2.9	71.6						
26	1.3	33.5	2.0	52.7	2.8	73.2						
27	1.3	34.5	2.0	54.1	2.8	74.8						
28	1.3	35.6	2.0	55.4	2.7	76.5						
29	1.3	36.6	2.0	56.8	2.7	78.1						
30	1.3	37.6	1.9	58.1	2.7	79.7						
31	1.2	38.5	1.9	59.3	2.6	81.1						
32	1.2	39.4	1.9	60.6	2.6	82.5						
33	1.2	40.4	1.9	61.8	2.5	83.8						
34	1.2	41.3	1.9	63.1	2.5	85.2						
35	1.2	42.2	1.8	64.3	2.5	86.6						
36	1.2	43.1	1.8	65.3								

Power Supplies

See Power Supply instructions and spec sheet for wiring information. For a complete list of compatible dimmers, see Compatible Dimming Chart on the Resources page.

Universal Power Supply 1% 120VAC - 277VAC

MODEL	POWER	OUTPUT
PDCU-D - IP20 Dry Series	30 - 30 W 60 - 60 W 96 - 96 W 3X96 - 3X96 W	24 - 24 VDC
PDCU-W - IP66 Wet Series	96 - 96 W 3X96 - 3X96 W	

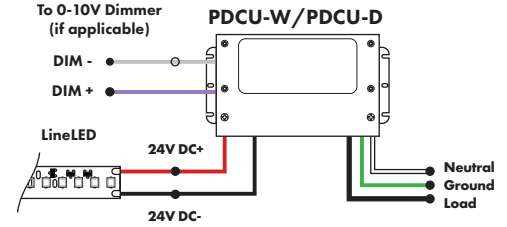

0-10V dims down to 1%, MLV/ELV/TRIAC dims down to 1%.
For a complete list of compatible dimmers, see [Compatible Dimming Chart](#) on the Resources page.

MODELS	PDCU-W 96W	PDCU-W 3X96W	PDCU-D 30W	PDCU-D 60W	PDCU-D 96W	PDCU-D 3X96W
Length	8.66"	11.85"	6.10"	7.93"	8.25"	9.57"
Width	3.73"	4.32"	3.35"	3.35"	4.10"	5.94"
Depth	1.61"	1.81"	1.33"	1.32"	1.56"	1.13"

0-10V Dimming Power Supplies 0.1% 120VAC - 277VAC

MODEL	POWER	OUTPUT	DIMMING
PS010V - 0-10V Power Supply dims down to 0.1%	96 - 96 Watt 3X96 - 3 X 96 Watt	24 - 24 VDC	LIN - Linear LOG - Logarithmic

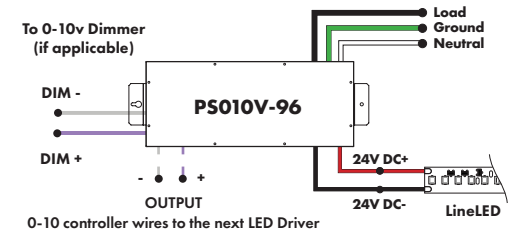

MODELS	96W	3X96
Length	14.40"	15.75"
Width	5.20"	6.62"
Depth	2.60"	4.95"

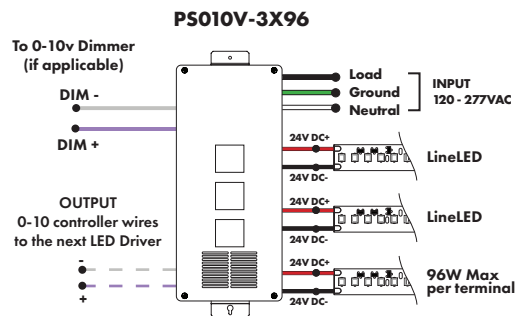

Triac, MLV, ELV, & PWM Compatible Dimmers

MODEL	POWER	OUTPUT
PDC - (IP20) Power Supply	96 - 96 Watts	24 - 24 VDC

MODELS	96W
Length	8.25"
Width	4.10"
Depth	1.56"

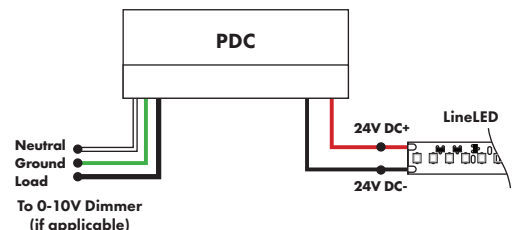

Power Supplies

See Power Supply instructions and spec sheet for wiring information. For a complete list of compatible dimmers, see Compatible Dimming Chart on the Resources page.

DMX Dimming Power Supplies 120VAC - 277VAC

MODEL	POWER	OUTPUT
PSDMX - DMX Power Supply dims down to 0%	96 - 96 Watt 3X96 - 3 X 96 Watt	24 - 24 VDC

Features eldoLED's LINEARdrive configurable dimmable drivers

MODELS	96W	3X96
Length	14.40"	15.75"
Width	5.20"	6.62"
Depth	2.60"	4.95"

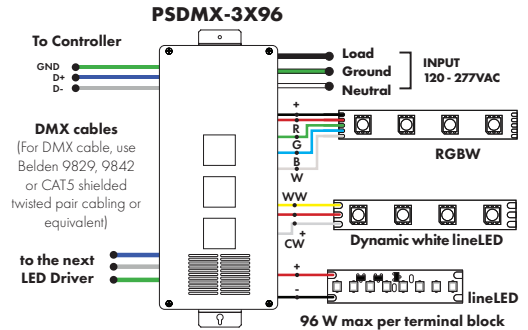
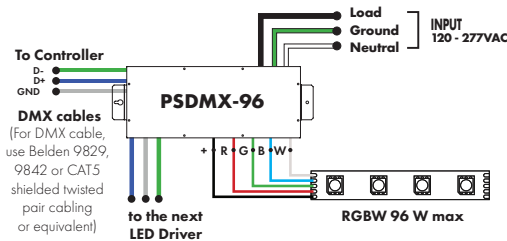

DALI 0% Dimming Power Supplies 120VAC - 277VAC

MODEL	POWER	OUTPUT
PSDALI - DALI Power Supply dims down to 0%	96 - 96 Watt 3X96 - 3 X 96 Watt	24 - 24 VDC

Features eldoLED's LINEARdrive configurable dimmable drivers

Model	96W	3X96
Length	14.40"	15.75"
Width	5.20"	6.62"
Depth	2.60"	4.95"

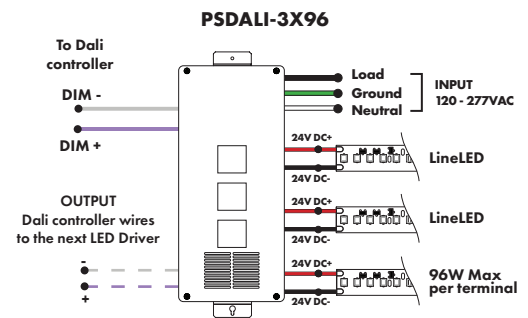
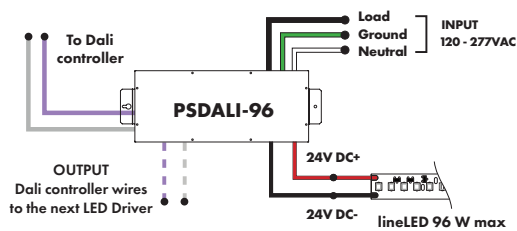

Enlighted Enabled Dimming Power Supplies 120VAC - 277VAC

MODEL	POWER	OUTPUT	DIMMING	LOCATION
PSV - PSV Series	96 - 96 Watt	24 - 24 VDC	ENL - Enlighted Dimming dims down to 0%	D - Damp

Model	96W
Length	14.40"
Width	5.20"
Depth	2.60"

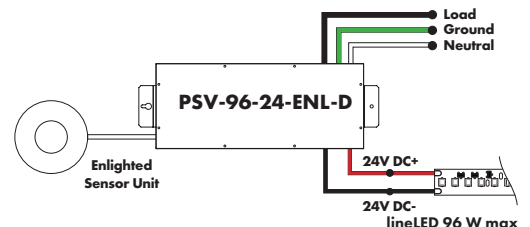

Power Supplies

See Power Supply instructions and spec sheet for wiring information. For a complete list of compatible dimmers, see Compatible Dimming Chart on the Resources page.

Non-Dimming Power Supply 120VAC - 277VAC

MODEL	POWER	OUTPUT	DIMMING	LOCATION
PSV - PSV Series	96 - 96 Watt	24 - 24 VDC	U2ND - Non Dimming	D - Damp

MODELS	96W
Length	14.40"
Width	5.20"
Depth	2.60"

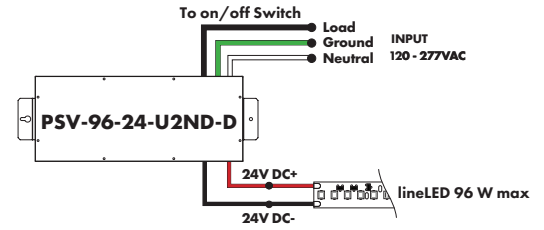

Luminii is a Lutron OEM Advantage Partner

Lutron Power Supplies 1%

MODEL	MODEL
LTEA4U1UKL-CV240	L3DA4U1UKL-CV240
Lutron - HiLume™ 1% 2-wire LED Driver 40W max	HiLume™ 1% EcoSystem Voltage LED driver 40W max
(120V forward phase only)	

MODELS	LTEA4U1UKL-CV240	L3DA4U1UKL-CV240
Length	4.89"	4.98"
Width	4.00"	4.00"
Depth	2.62"	2.62"

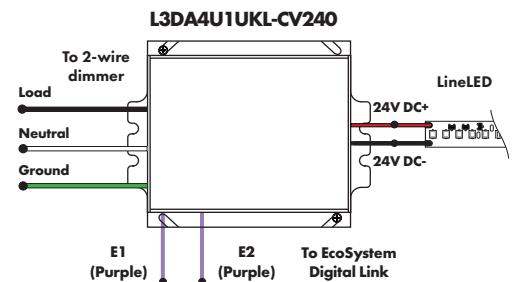
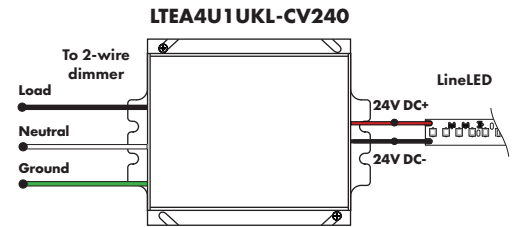

Luminii is a Lutron OEM Advantage Partner

Lutron Power Supplies 0.1%

MODEL
L3D0-96W24V-U
HiLume™ 0.1% EcoSystem Voltage LED Driver with Soft-On, Fade-to-Black™ 96W max

MODELS	L3D0
Length	10.50"
Width	5.50"
Depth	2.00"

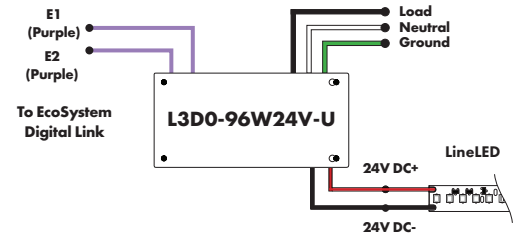

In-Ground Power Supplies

MODEL	POWER	OUTPUT	INPUT
IG - In ground CVE Series	CVE - ELV Dimming DALI - eidoLED Dali dimming Both dims down to 0%	96X2 - 2 X 96 Watt	24 - 24 VDC
			Blank - 120 V 277 - 240/277 V

MODELS	Dual Circuit
Length	8.40"
Width	8.30"
Depth	8.10"

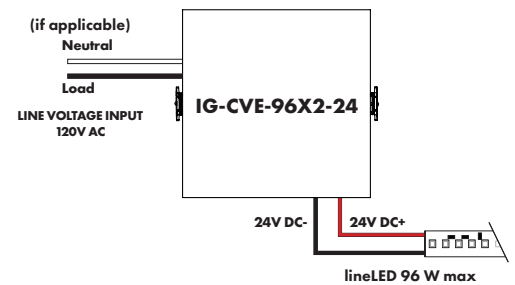

Legacy Conversion

	Legacy LL Tapes			NEW LL Tapes			
	lm/ft	W/ft	LPW	lm/ft	W/ft	LPW	
LL18WET-T	121	1.5	81	LL42WET-T-SO	130	1.4	93
LL30WET-T	190	2.5	76	LL42WET-T-HO	225	2.4	94
LL36WET-T	244	3.0	81				
LL54WET-T	353	4.5	78	LL42WET-T-VHO	320	3.6	88
LLX18WET-T	371	4.9	80				