

LETO 44 PLUS WM UD MID

WALL MOUNT LED UPLIGHT AND DOWNLIGHT

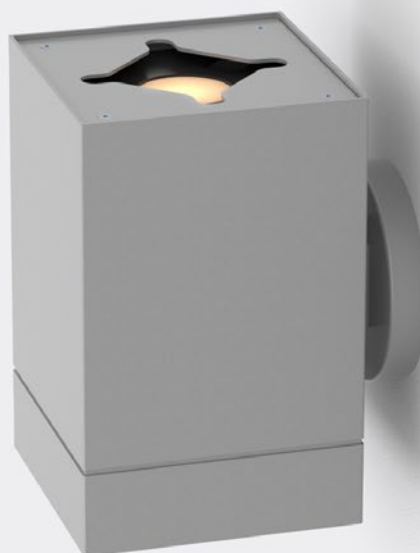

Leto 44 Plus WM UD MID - Wall Mount LED Light. Leto 44 Plus WM UD MID is a wall mounted cylinder LED fixture designed to provide a space with indirect up and down lighting.

Ordering Code

Fixture	722							
	1	2	3	4	5	6	7	8
Driver			--	--				
	1	2	3	4				

Product Specifications

SAMPLE: Fixture **722 - A90 - 61015 - 27 - 0707 - HO - 08 - 01** | Driver **STD - 120 - A90 - 07**

1 - Model	2 - LED	3 - Optic		4 - CCT	5 - Lumen	6 - Accessory*1
722 · Leto 44 Plus Direct and Indirect Medium Wall Mount	A90 · 93+ CRI Accuracy	<i>Direct</i> 610 · 10° 618 · 18° 630 · 30° 645 · 45° 660 · 60°	<i>Indirect</i> 15 · 15° 24 · 24° 60 · 60°	25 · 2500K 27 · 2700K 30 · 3000K 35 · 3500K 40 · 4000K 65 · 6500K	<i>Direct / Indirect</i> 0707 · 700/700 1010 · 1000/1000 <i>For other direct / indirect possibilities please contact factory team</i> Wattage on page 3	00 · No Accessory DL · Diffusing Lens HO · Honeycomb SL · Solite Lens <i>Fixed Diffusing lens for indirect optic</i>

7 - Body Color		8 - Baffle Color		1 - Driver	Dim Level	Dim Level
<i>Standard</i> 01 · White 02 · Black 08 · Silver	<i>Premium</i> 52 · Mocha 53 · Charcoal 54 · Cerulean 55 · Firebrick XX · RAL	<i>Standard</i> 01 · White 02 · Black 08 · Silver	<i>Premium</i> 52 · Mocha 53 · Charcoal 54 · Cerulean 55 · Firebrick XX · RAL	STD · Non Dimming LCS · 0 - 10 Volt Protocol DIM · Phase*2 ELDOLC · EldoLED 0 - 10 Volt DALI · Dali Protocol	N/A 1% 1% 0.1% 0.1%	LUTES · Hilume Ecodigital 1% DMX · Senso EMG · Emergency Driver*3/4 CSMB · Casambi Wireless Control*3/4

2 - Voltage	3 - LED	4 - Lumen		
120 · 120V 277 · 277V 347 · 347V*3/5	Same as Fixture	Same as Fixture	*1 available on downlight only *2 120V only *3 remote mount *4 second driver required *5 not available with ELDO, Lutron or DMX	Project : _____ Quantity : _____ Type : _____ Notes : _____

LETO 44 PLUS WM UD MID

WALL MOUNT LED UPLIGHT AND DOWNLIGHT

Reflector

Faceted Reflector

Senso metal spun faceted reflectors are specifically designed to retain as much light as possible. This results in a more power efficient fixture with a higher delivered lumen.



Installation

- Mounting plate included
- Easy, single motion installation method

Construction / Finish

- High quality, scratch resistant powder coated finish in standard, premium or custom colors
- Aluminum extruded Body
- Made in Canada

Dimensions

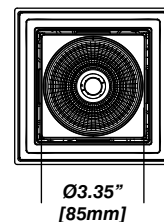
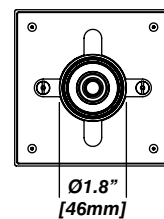
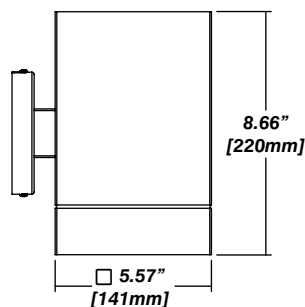

Accessories

Diffusing Lens

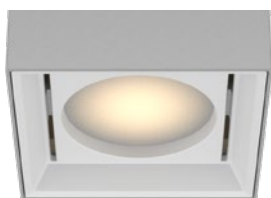

Honeycomb Mesh

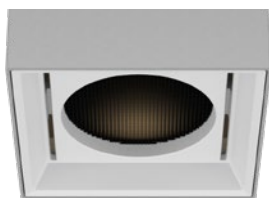

Solite Lens

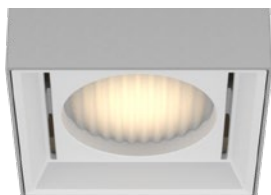

LETO 44 PLUS WM UD MID

WALL MOUNT LED UPLIGHT AND DOWNLIGHT

Senso's in-house photometric testing ensures that our lighting design can match your needs precisely. Our Goniophotometer and testing lab produces on-demand photometry files based on any specified fixture, including LM-79 Test reports, IES Files, and CRI/CCT measurements. See Sensolighting.com for more information.

**Full photometric Reports and IES files available for every configuration*

Leto 44 Light Distribution

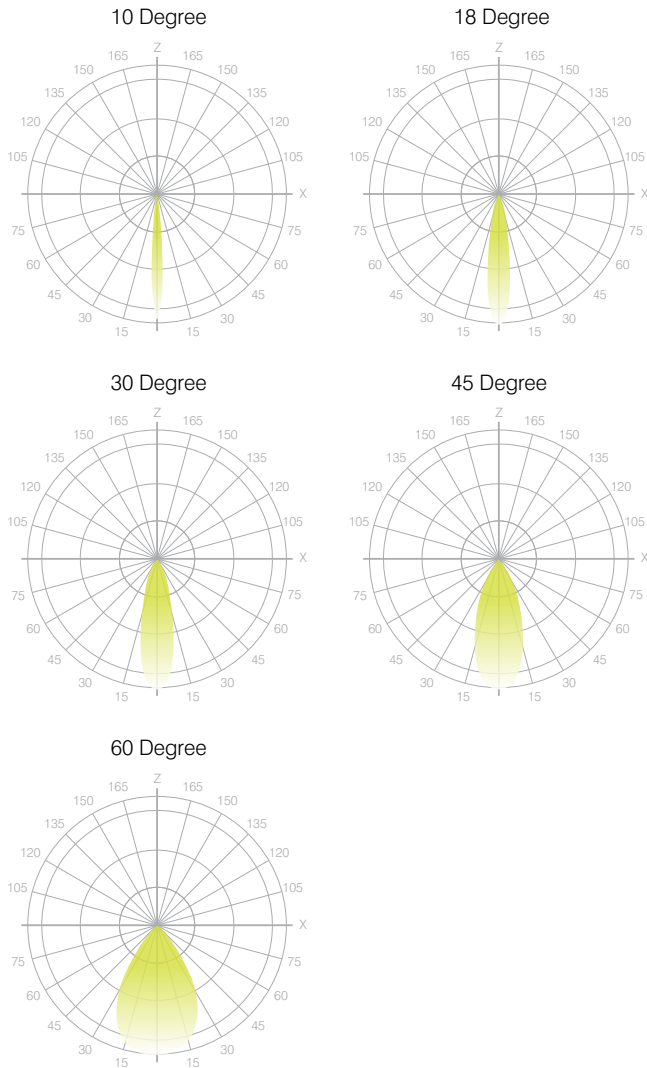

Color Metrics

TM 30-15

Our clients deserve the best information possible about their lighting choices. That's why Senso has invested in the Illuminating Engineering Society (IES) TM 30-15, a new system that measures an LED light source's color rendering properties. Using Senso's state-of-the-art goniophotometer, this method identifies the optimal light source for your project and helps evaluate the trade-offs between efficacy and color rendering. Senso can provide TM 30-15 data for all of our products.

**Full Color Metric Info Available at Sensolighting.com*

LED Module Performance

Output: Up to 101 lumen/Watt

Efficacy: Color consistency within a 3-MacAdam Ellipse

CCT: 2500K - 6500K

Color Rendering: 90+ CRI

Min. R Values: R⁹ - 60 R¹ - 90 R⁹ - 100

Driver and Power Consumption

Dimming: 1% dimming standard with 0.1% option

Casambi wireless control available

Ripple: Industry leading Low ripple

Efficiency: Power Factor >0.9

Efficiency over 85%

Class 2 output for safety

Integral Drivers: STD, LCS, DIM, ELDOLC, DALI, LUTES

All other drivers require remote mounting

Lumen Option	700/700	1000/1000
Fixture Wattage	15W	20W
Delivered Lumen	1312lm	2070lm