

LETO 44 P UD LRG

DIRECT AND INDIRECT LED PENDANT



Leto 44 P UD LRG - Direct and Indirect LED Pendant. Solid, striking and bold, the Leto 44 P UD LRG is the flagship of the Leto 44 Range with the added versatility of a secondary uplight.

Ordering Code

Fixture	723								
	1	2	3	4	5	6	7	8	
Driver							--	--	
	1	2	3	4	5	6	7	8	

Product Specifications

SAMPLE: Fixture **723 - A90 - 615 - 27 - 0707 - 00 - 08 - 01** | Driver **952 - 01 - 02 - 01 - STD - 120 - A90 - 0707**

1 - Model	2 - LED	3 - Optic Direct	4 - CCT	5 - Lumen	6 - Accessory Direct ¹
723 · Leto 44 Large Direct and Indirect Pendant	A90 · 93+ CRI Accuracy	615 · 15° 630 · 30° 645 · 45° 660 · 60° <i>Fixed 40° indirect optic</i>	25 · 2500K 27 · 2700K 30 · 3000K 35 · 3500K 40 · 4000K 65 · 6500K	<i>Direct / Indirect</i> 0707 · 700/700 1010 · 1000/1000 <i>For other direct / indirect possibilities please contact factory team</i> <i>Wattage on page 3</i>	00 · No Accessory DL · Diffusing Lens HO · Honeycomb SL · Solite Lens <i>Fixed Diffusing lens for indirect optic</i>

7 - Body Color	8 - Baffle Color	1 - Canopy Style	2 - Canopy Color	3 - Suspension (6' incl.)	
<i>Standard</i> 01 · White 02 · Black 08 · Silver	<i>Premium</i> 52 · Mocha 53 · Charcoal 54 · Cerulean 55 · Firebrick XX · RAL	<i>Standard</i> 01 · White 02 · Black 08 · Silver	<i>Premium</i> 52 · Mocha 53 · Charcoal 54 · Cerulean 55 · Firebrick XX · RAL	956 · Square	<i>Standard</i> 01 · White 02 · Black 08 · Silver
				<i>Premium</i> 52 · Mocha 53 · Charcoal 54 · Cerulean 55 · Firebrick XX · RAL	
				02 · 2 Aircraft + Feed Cable 05 · 2 Powered Aircraft ² <i>Contact Senso for custom length</i>	

4 - Feed Cable	5 - Driver	Dim Level	5 - Driver	Dim Level	6 - Voltage	7 - LED	8 - Lumen
00 · None ² 01 · White 02 · Black 03 · Clear XX · Custom	STD · Non Dimming LCS · 0 - 10 Volt Protocol DIM · Phase ³ ELDOLC · EldoLED 0 - 10 Volt DALI · Dali Protocol	N/A 1% 1% 0.1% 0.1%	LUTES · Hilume Ecodigital DMX · Senso ⁴ EMG · Emergency Driver ^{4/5} CSMB · Casambi Wireless Control ^{4/5}	1% 1% 4/5 4/5	120 · 120V 277 · 277V 347 · 347V ^{4/6}	Same as Fixture	Same as Fixture

¹ available on downlight only

² no feed cable color option for **05** - 2 Powered Aircraft

³ 120V only

⁴ remote mount

⁵ second driver required

⁶ not available with ELDO, Lutron or DMX

LETO 44 P U D LRG

DIRECT AND INDIRECT LED PENDANT



Canopy

Square Canopy: W/L - 5.67" [144mm] / H - 2.28" [58mm]

Drivers mounted in the Square Canopy: **STD, LCS, DIM, ELDOLC, DALI, LUTES**

Drivers remote mounted: **DMX, EMG, CSMB**

2 Aircraft Cable
w/ Feed Cable

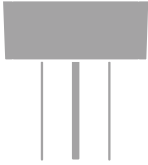

2 Powered
Aircraft Cable

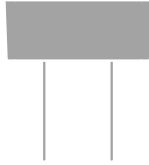

Suspension

Double Aircraft Cable

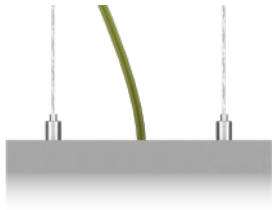

Powered Aircraft

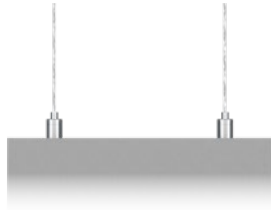

Body Accessories

Diffusing Lens

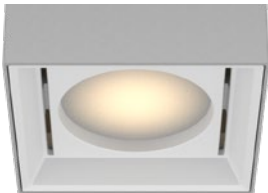

Honeycomb Mesh

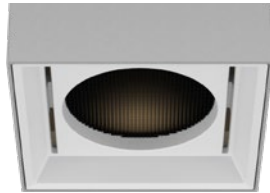

Solite Lens

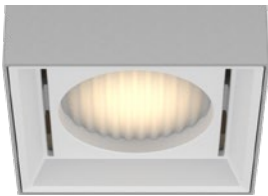

Installation

- The included canopy fits on a standard junction box
- Height adjustable aircraft cable and feed cable
- Electrical feed cable included

Construction / Finish

- High quality, scratch resistant powder coated finish in standard, premium or custom colors
- Aluminum extruded Body
- Made in Canada

Dimensions

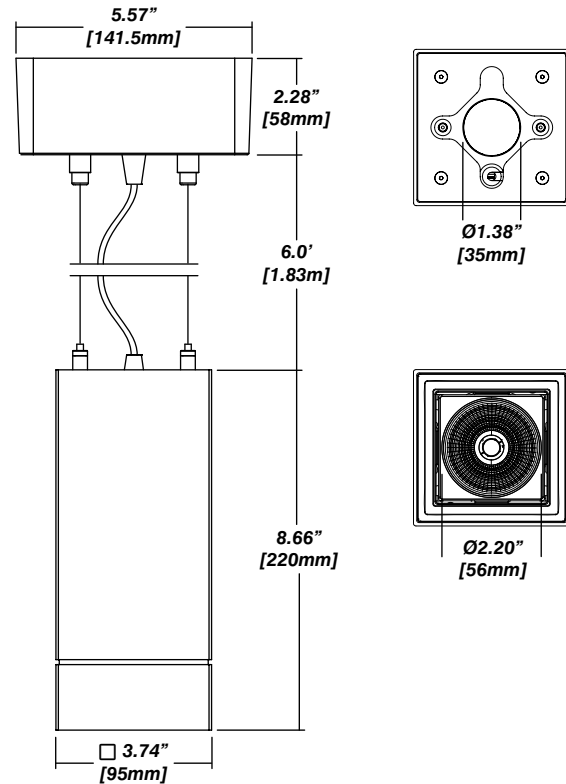

Reflector

Senso metal spun faceted reflectors are specifically designed to retain as much light as possible. This results in a more power efficient fixture with a higher delivered lumen.

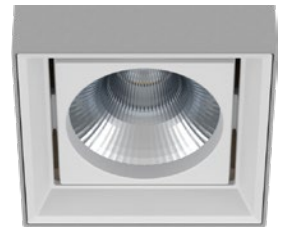

LETO 44 P U D LRG

DIRECT AND INDIRECT LED PENDANT



Photometrics

Senso's in-house photometric testing ensures that our lighting design can match your needs precisely. Our Goniophotometer and testing lab produces on-demand photometry files based on any specified fixture, including LM-79 Test reports, IES Files, and CRI/CCT measurements. See Sensolighting.com for more information.

**Full photometric Reports and IES files available for every configuration*

Leto 44 Light Distribution

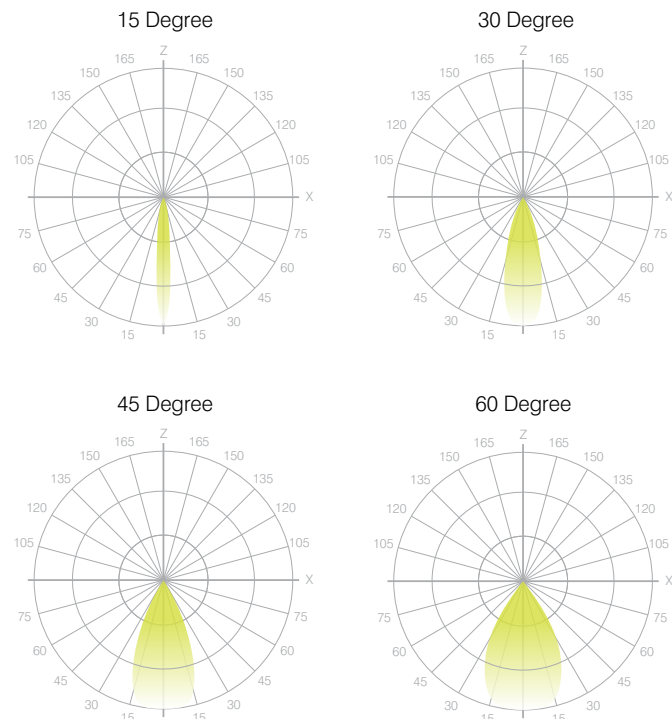

Color Metrics

TM 30-15

Our clients deserve the best information possible about their lighting choices. That's why Senso has invested in the Illuminating Engineering Society (IES) TM 30-15, a new system that measures an LED light source's color rendering properties. Using Senso's state-of-the-art goniophotometer, this method identifies the optimal light source for your project and helps evaluate the trade-offs between efficacy and color rendering. Senso can provide TM 30-15 data for all of our products.

**Full Color Metric Info Available at Sensolighting.com*

LED Module Performance

- Output:** Up to 103 lumen/Watt
- Efficacy:** Color consistency within a 3-MacAdam Ellipse
- CCT:** 2500K - 6500K
- Color Rendering:** 90+ CRI
- Min. R Values:** R⁹ - 60 R^f - 90 R^a - 100

Driver and Power Consumption

- Dimming:** 1% dimming standard with 0.1% option
Casambi wireless control available
- Ripple:** Industry leading Low ripple
- Efficiency:** Power Factor >0.9
Efficiency over 85%
Class 2 output for safety
- Installation:** Canopy or remote mounted

Lumen Option	700/700	1000/1000
Fixture Wattage	15W	20W
Delivered Lumen	1312lm	2070lm