

LETO 44 Mini S

SURFACE MOUNT LED DOWNLIGHT

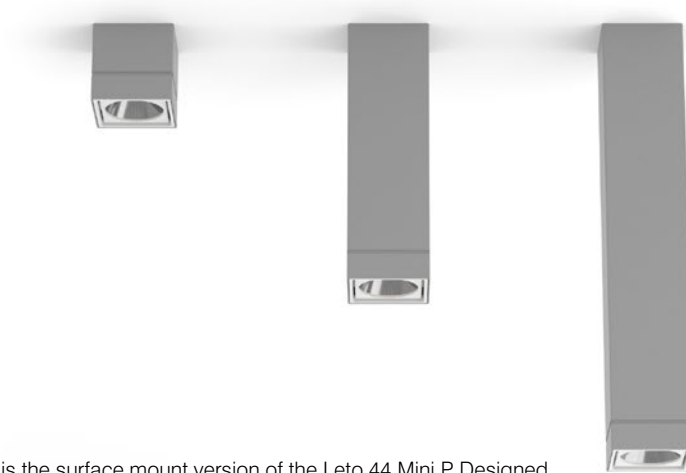

LETO 44 Mini S - Surface LED Light. Leto 44 Mini S is the surface mount version of the Leto 44 Mini P. Designed as an all purpose light, it's perfect for creating even light throughout your space without distracting from your design.

Ordering Code

Fixture	657								
	1	2	3	4	5	6	7	8	9
Driver					--	--			
	1	2	3	4	5	6			

Product Specifications

SAMPLE: Fixture **657 - S - A90 - 617 - 27 - 07 - 00 - 08 - 01** | Driver **STD - 120 - A90 - 07**

1 - Model	2 - Size	3 - CRI/LED	4 - Optic	5 - CCT	6 - Lumen	7 - Accessory
657 · Leto 44 Mini Surface Mount	S · Small (73mm) ² M · Medium (209mm) L · Large (346mm)	A90 · Accuracy	617 · 17° 624 · 24° 660 · 60°	25 · 2500K 27 · 2700K 30 · 3000K 35 · 3500K 40 · 4000K 65 · 6500K	07 · 700 (6W) 10 · 1000 (9W) 15 · 1500 (14W)	00 · No Accessory DL · Diffusing Foil HO · Honeycomb ¹

8 - Body Color		9 - Baffle Color		1 - Canopy Style	2 - Canopy Color	
<i>Standard</i>	<i>Premium</i>	<i>Standard</i>	<i>Premium</i>	955 · Round Slim ^{2/3} 954 · Round Semi-Recessed	<i>Standard</i>	<i>Premium</i>
01 · White 02 · Black 08 · Silver	52 · Mocha 53 · Charcoal 54 · Cerulean 55 · Firebrick XX · RAL	01 · White 02 · Black 08 · Silver	52 · Mocha 53 · Charcoal 54 · Cerulean 55 · Firebrick XX · RAL		01 · White 02 · Black 08 · Silver	52 · Mocha 53 · Charcoal 54 · Cerulean 55 · Firebrick XX · RAL

3 - Driver		Dim Level	Dim Level	4 - Voltage	5 - CRI/LED	6 - Lumen
STD · Non Dimming	N/A	DALI · Dali Protocol ⁵	0.1%	120 · 120V	Same as Fixture	Same as Fixture
LCS · 0 - 10 Volt Protocol	1%	LUTES · Hilume Ecodigital ⁵	1%	277 · 277V		
DIM · Phase ⁴	1%	LUT2W · 2 Wire for phase ^{4/5}	1%	347 · 347V ^{5/6}		
ELDOLC · EldoLED 0 - 10 Volt ⁵	0.1%	LUT5S · 5 Series Eco System ⁵	5%			

*1 accessories not available with small size

*4 120V only

*2 driver mounted in junction box with 955 canopy and Small size

*5 remote mount

*3 10mm stem required for Round Slim see page 2 Canopy section

*6 not available with DALI or Lutron drivers

LETO 44 Mini S

SURFACE MOUNT LED DOWNLIGHT



Light Engine

- Output:** up to 1500lm
- High Efficacy:** up to 150 lumen/Watt
- Color Options (CCT):** 2500K, 2700K, 3000K, 3500K, 4000K, 6500K
- Color Consistency:** Range within a 3-MacAdam Ellipse
- Color rendering (CRI):** 90 CRI & 50+ R9 Value

Driver

- Dimming:** 1% dimming standard with 0.1% option
- Ripple:** Industry leading Low ripple
- Efficiency:** Power Factor >0.9
Efficiency over 85%
Class 2 output for safety

Dimensions

L - Large

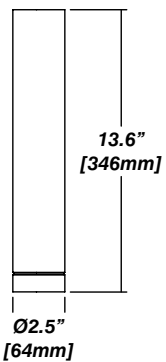

M - Medium

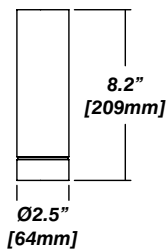

S - Small

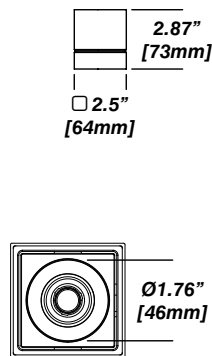

Accessories

Frosted Lens



Honeycomb

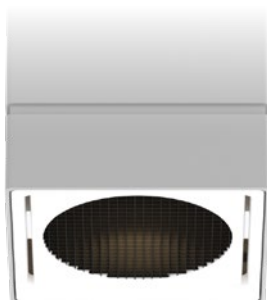

Installation

- Pre-assembled for quick and easy installation
- Flush mount to ceiling for gapless appearance

Construction

- Machined aluminum construction
- High quality, scratch resistant powder coated finish in standard, premium or custom colors
- Made in Canada

Canopy

955 - Round Slim

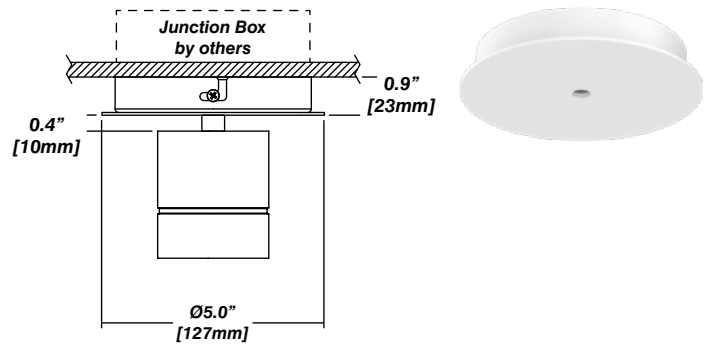

954 - Semi-Recessed + Cylinder Driver Housing

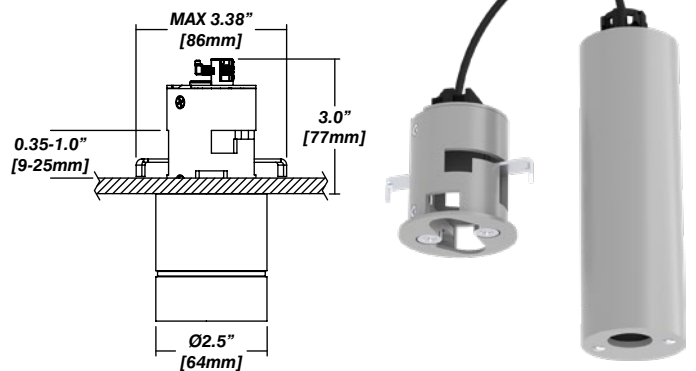

Ø2.125"
[54mm]

CUT-OUT

LETO 44 Mini S

SURFACE MOUNT LED DOWNLIGHT

Senso Driver Housings

910 - Single Remote Driver Housing

- Fits Standard, LCS or DIM drivers
- Galvanized steel enclosure
- Installed in remote location

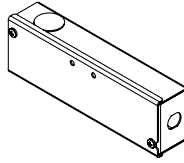

Dimensions

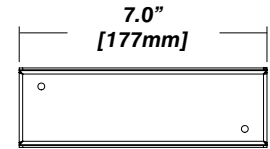
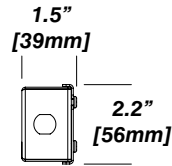

910 - Double Remote Driver Housing

- Fits all drivers
- Galvanized steel enclosure
- Installed in remote location

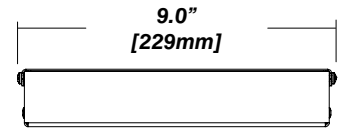
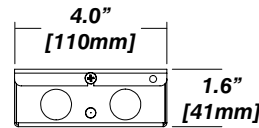
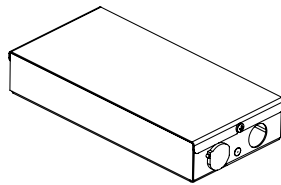

954 - Cylinder Driver Housing

- Supplied standard with every semi-recessed canopy
- Fits Standard, LCS or DIM drivers
- Extruded aluminum enclosure with strain relief to fixture
- Installed in ceiling beside canopy

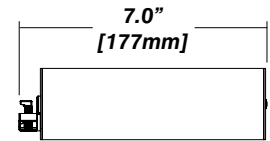
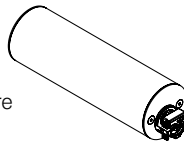

954 Driver Layouts

954 with Cylinder Driver Housing

- Installed in ceiling beside canopy
- Driver mounted inside cylinder
- Dimming control wired from Cylinder Driver Housing

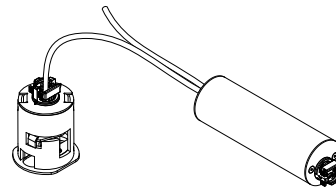

954 with Cylinder Driver Housing

+ 910 Single Driver Housing

- Driver remotely mounted inside 910 housing
- Fed directly to 954 cylinder for DC connections (wire and strain reliefs supplied by others)

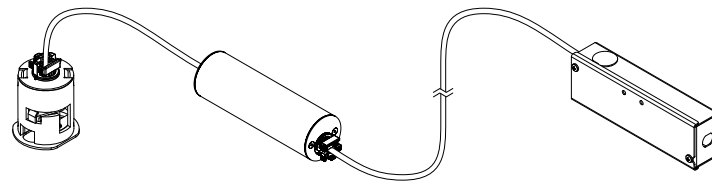

954 with Cylinder Driver Housing

+ 910 Double Driver Housing

- Driver remotely mounted inside 910 housing
- Fed directly to 954 cylinder for DC connections (wire and strain reliefs supplied by others)

