

# LETO 11 Mini MP

SURFACE LED SPOTLIGHT



**LETO 11 Mini MP - Surface Mount Spotlight.** Leto 11 Mini MP offers an articulating, short-stem spotlight combined with a versatile and efficient LED. Excels in display based spaces like galleries, industrial and retail.

## Ordering Code

Fixture	<b>625</b>								
	1	2	3	4	5	6	7		
Driver								--	--
	1	2	3	4	5	6	7	8	9

## Product Specifications

**SAMPLE:** Fixture **625 - A90 - 717 - 27 - 07 - 08 - 01** | Driver **955 - 08 - 03 - 01 - 06 - STD - 120 - A90 - 07**

1 - Model	2 - LED	3 - Optic	4 - CCT	5 - Lumen	6 - Body Color
<b>625</b> · Leto 11 Mini Monopoint	<b>A90</b> · 93+ CRI Accuracy <b>CT</b> · Color Tuning <sup>*CT</sup> (90 CRI) <b>WD</b> · Warm Dimming <sup>*WD</sup> (90 CRI)	<b>717</b> · 17° <b>724</b> · 24° <b>760</b> · 60°	<b>25</b> · 2500K <b>27</b> · 2700K <b>30</b> · 3000K <b>35</b> · 3500K <b>40</b> · 4000K <b>65</b> · 6500K <b>2765</b> · 2700K - 6500K <sup>*CT</sup>	<b>07</b> · 700 (6.1W) <sup>*WD</sup> <b>10</b> · 1000 (9.1W) <sup>*WD/*CT</sup> <b>15</b> · 1500 (14W)	<i>Standard</i> <b>01</b> · White <b>02</b> · Black <b>08</b> · Silver  <i>Premium</i> <b>52</b> · Mocha <b>53</b> · Charcoal <b>54</b> · Cerulean <b>55</b> · Firebrick <b>BZ</b> · Bronze <b>WN</b> · Warm Nickel <b>AB</b> · Aged Brass <b>XX</b> · RAL
7 - Baffle Color	1 - Canopy Style	2 - Canopy Color	3 - Suspension Type	4 - Stem Color	
<i>Standard</i> <b>01</b> · White <b>02</b> · Black <b>08</b> · Silver  <i>Premium</i> <b>52</b> · Mocha <b>53</b> · Charcoal <b>54</b> · Cerulean <b>55</b> · Firebrick <b>BZ</b> · Bronze <b>WN</b> · Warm Nickel <b>AB</b> · Aged Brass <b>XX</b> · RAL	<b>955</b> · Round Slim <b>965</b> · Square Slim <b>955F</b> · Round Flangeless <b>954</b> · Round Semi-Recessed	<i>Standard</i> <b>01</b> · White <b>02</b> · Black <b>08</b> · Silver  <i>Premium</i> <b>52</b> · Mocha <b>53</b> · Charcoal <b>54</b> · Cerulean <b>55</b> · Firebrick <b>BZ</b> · Bronze <b>WN</b> · Warm Nickel <b>AB</b> · Aged Brass <b>XX</b> · RAL	<b>03</b> · Solid Stem	<i>Standard</i> <b>01</b> · White <b>02</b> · Black <b>08</b> · Silver  <i>Premium</i> <b>52</b> · Mocha <b>53</b> · Charcoal <b>54</b> · Cerulean <b>55</b> · Firebrick <b>BZ</b> · Bronze <b>WN</b> · Warm Nickel <b>AB</b> · Aged Brass <b>XX</b> · RAL	
5 - Stem Height	6 - Driver	Dim Level	7 - Voltage	8 - LED	9 - Lumen
<b>01</b> · 1" <b>06</b> · 6" <b>12</b> · 12" <b>24</b> · 24" <b>XX</b> · Custom (in inches)	<b>STD</b> · Non Dimming <sup>*4</sup> <b>LCS</b> · 0 - 10 Volt Protocol <sup>*4</sup> <b>DIM</b> · Phase <sup>*1/4</sup> <b>ELDOLC</b> · EldoLED 0 - 10 Volt <sup>*2/CT</sup> <b>DALI</b> · Dali Protocol <sup>*2/CT</sup> <b>LUTES</b> · Hilume Ecodigital <sup>*2</sup> <b>LUT2W</b> · 2 Wire for phase <sup>*1/2</sup> <b>CSMB</b> · Casambi Wireless Control <sup>*2/CT</sup>	N/A 1% 1% 0.1% 0.1% 1% 1%	<b>120</b> · 120V <b>277</b> · 277V <b>347</b> · 347V <sup>*2/3</sup>	Same as Fixture	Same as Fixture

\*1 120V only

\*2 remote mount

\*3 not available with DALI or Lutron drivers

\*4 can be junction box mount

# LETO 11 Mini MP

SURFACE LED SPOTLIGHT



## Light Engine: A90 Accuracy

- Output:** up to 1000lm
- High Efficacy:** up to 110 lumen/Watt
- Color Options (CCT):** 2500K, 2700K, 3000K, 3500K, 4000K,
- Color Consistency:** Range within a 3-MacAdam Ellipse
- Color rendering (CRI):** 93+ CRI & 50+ R9 Value

### Driver

- Dimming:** 1% dimming standard with 0.1% option
- Ripple:** Industry leading Low ripple
- Efficiency:** Power Factor >0.9  
Efficiency over 85%  
Class 2 output for safety

## Light Engine: Warm Dimming

- Output:** 1000lm
- High Efficacy:** up to 98 lumen/Watt
- Color Temperature (CCT):** 3000K dimmed to 1800K
- Color Consistency:** Range within a 3-MacAdam Ellipse
- Color rendering (CRI):** 90 CRI

### Driver

- Dimming:** 1% dimming standard with 0.1% option  
Dimmer switch must be capable of dimming less than 5% (Lutron DIVA is recommended)
- Ripple:** Industry leading Low ripple
- Efficiency:** Power Factor >0.9  
Efficiency over 85%  
Class 2 output for safety
- Installation:** Small Footprint allows retrofit installations

## Light Engine: Color Tuning

- Output:** up to 1000lm
- High Efficacy:** up to 95 lumen/Watt
- Color Temperature (CCT):** 2700K up to 6500K
- Color Consistency:** Range within a 3-MacAdam Ellipse
- Color rendering (CRI):** 90 CRI

### Driver

- Dimming:** EldoDA, DALI, Casambi
- Ripple:** Industry leading Low ripple
- Efficiency:** Power Factor >0.9  
Efficiency over 85%  
Class 2 output for safety
- Installation:** Small Footprint allows retrofit installations

## Installation

- 330° of rotation and 80° of tilt
- Preset stem height between 1" and 24" OR custom heights available

## Construction

- Machined aluminum construction
- Scratch resistant, satin powder coat finish
- Made in Canada

## Dimensions

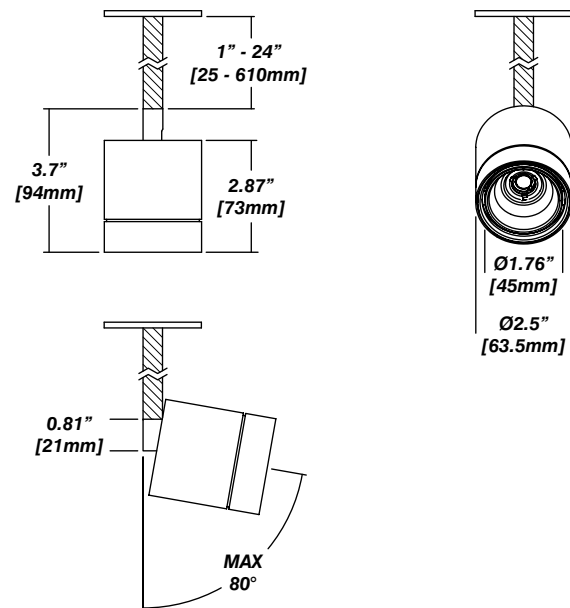

## Driver Placement

- **Standard, LCS, and Phase dimming** drivers may be mounted in the junction box.
- Minimum volume required to mount drivers in junction box:

**70mm x 40mm x 30mm**

J-box - BC54151-LD or equivalent 1.5" x 4"  STD / LCS / DIM Driver

Canopy Mounting Bracket for:  
955 Round Slim Canopy  
965 Square Slim Canopy

# LETO 11 Mini MP

SURFACE LED SPOTLIGHT



## Standard Finishes

01 - White

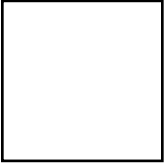

02 - Black



08 - Silver



## Premium Finishes

55 - Mocha



56 - Charcoal



57 - Cerulean



58 - Firebrick



BZ - Bronze



WN - Warm Nickle



AB - Aged Brass

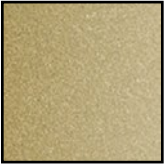

## Canopy

955 - Round Slim

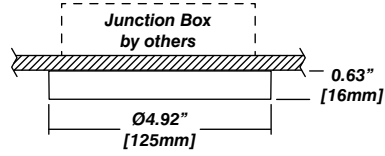

965 - Square Slim

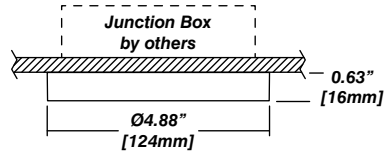

955F - Round Flangeless

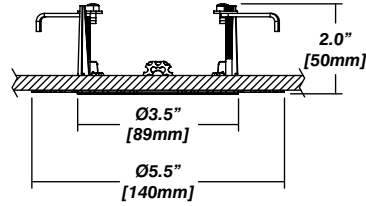

954 - Semi-Recessed + Cylinder Driver Housing

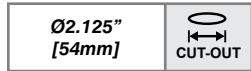
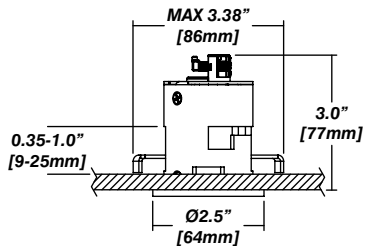

# LETO 11 Mini MP

SURFACE LED SPOTLIGHT



## Senso Driver Housings

### 910 - Single Remote Driver Housing

- Fits Standard, LCS or DIM drivers
- Galvanized steel enclosure
- Installed in remote location

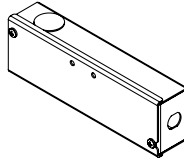

## Dimensions

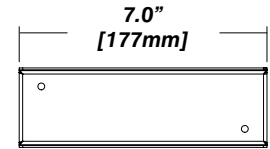
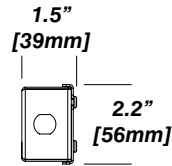

### 910 - Double Remote Driver Housing

- Fits all drivers
- Galvanized steel enclosure
- Installed in remote location

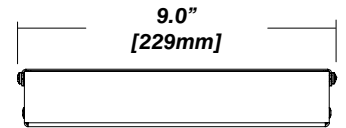
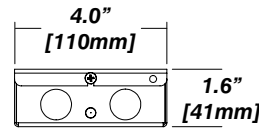
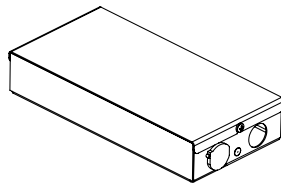

### 954 - Cylinder Driver Housing

- Supplied standard with every semi-recessed canopy
- Fits Standard, LCS or DIM drivers
- Extruded aluminum enclosure with strain relief to fixture
- Installed in ceiling beside canopy

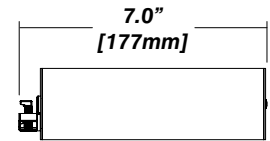
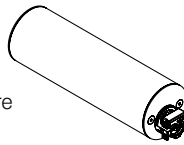

## 954 Driver Layouts

### 954 with Cylinder Driver Housing

- Installed in ceiling beside canopy
- Driver mounted inside cylinder
- Dimming control wired from Cylinder Driver Housing

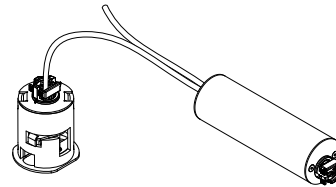

### 954 with Cylinder Driver Housing

#### + 910 Single Driver Housing

- Driver remotely mounted inside 910 housing
- Fed directly to 954 cylinder for DC connections (wire and strain reliefs supplied by others)

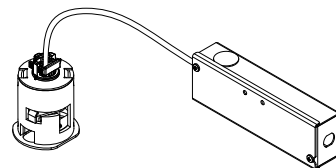

### 954 with Cylinder Driver Housing

#### + 910 Double Driver Housing

- Driver remotely mounted inside 910 housing
- Fed directly to 954 cylinder for DC connections (wire and strain reliefs supplied by others)

