

The KXL Channel linear aluminum extrusion has been designed to fit many LED lighting needs. Multiple mounting and lens options allow for great flexibility and adaptability for any application. Extrusion and diffuser lenses are also field cuttable. Substantial aluminum mass in profile provides excellent heat sink for high power LEDs. Mounting brackets and endcaps are available in multiple finishes and sold separately.

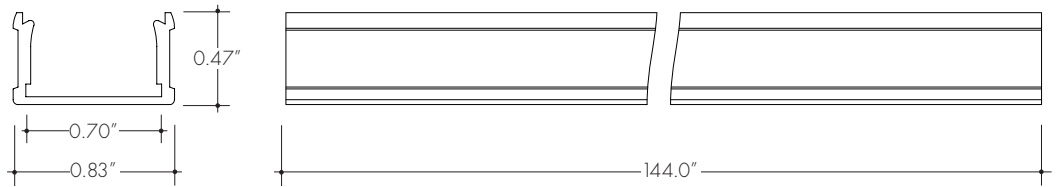
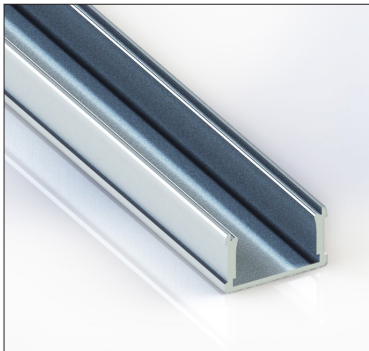

Technical information

Finish: Silver anodized, White

Diffuser lens: polycarbonate, snap-in-place, UV resistant

Mounting: multiple mounting brackets (page 2)

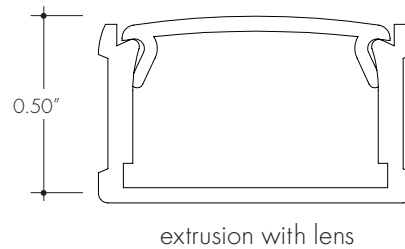

Lens Options	
Actual length	48", 72", 96", & 144"
Available lenses	- clear - frosted - half frosted

Ordering code

MODEL	LENGTH	DIFFUSER	FINISH
KXLC	48	C	SA
KXLC - KXL Channel	48 - 48" 72 - 72" 96 - 96" 144 - 144"	C - Clear F - Frosted HF - Half Frosted	SA - Silver anodized WH - White

NOTE: For Channels and Lenses over 90", incremental shipping charges will apply

All accessories sold separately.

Mounting brackets

MB-KXLC-SS Stainless steel screw-in mounting bracket

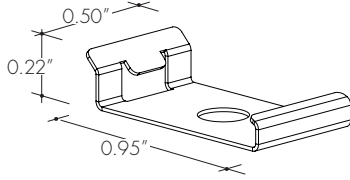

MB-KXLC-45-SS Stainless steel screw-in 45° mounting bracket

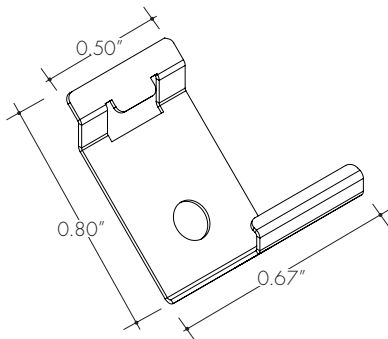

MB-KXLC-A-SA Silver anodized adjustable mounting bracket

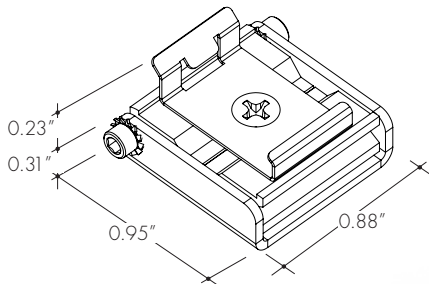

End-caps

EC-KXLC-F-H4-SA Silver anodized w/powerfeed opening
EC-KXLC-F-H4-WH White w/powerfeed opening

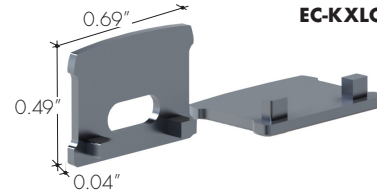

EC-KXLC-F-H3-SA Silver anodized
EC-KXLC-F-H3-WH White

