

## Features

Kurba Max Horizontal is a direct view, high output, energy efficient and flexible LED strip suitable for wet locations capable of horizontal/side bends up to 2.5" radius. Built with robust factory made power feeds or joiners, Kurba Max Horizontal mounts to a specifically designed aluminum extruded channel. Note: Color temperature of Kurba Max may not exactly match other profiles.

### Applications

Outdoor wet location

### Operating Voltage

24VDC

### Operating Temperature

-40°F to 113°F (-40°C to 45°C)

### Average Life

50,000 hours

### Dimming

Low voltage dimmer and class 2 dimming power supply required

### Approvals

Class 2 wet listed, IP67

### Warranty

3 years



## Technical Information

KBX-SF-	H	H-HO	CCT INFO / LUMEN MULTIPLIER	
			Color Temperature	Multiplier (ref. - 3000K)
LEDs/ft	43			
Light Output at 3000K	335 lm/ft	490 lm/ft		
Average Power Consumption at 4'	5.0 W/ft			
Ordering Increment	1.97"	2.19"		
Maximum Run Length (In Series)	18 ft			
			2200K	0.98
			2700K	1.01
			3000K	1.00
			3500K	1.08
			4000K	1.04

## Constraints

### Bend Direction

Bend LED in these positions only to avoid damage

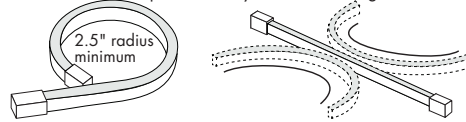

Illuminated surface shown in gray

### Prohibited Bends

Twisting or bending LED in these positions will cause damage

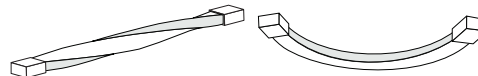

Illuminated surface shown in gray

Note: for horizontal bends refer to Luminii KBM series  
Do not make sharp bends near the endcap

## Power Feed Locations

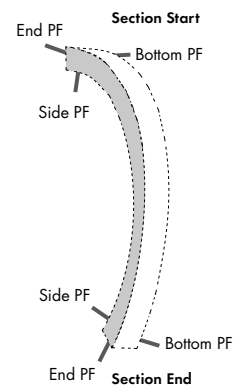

## Section Start/End Power Feed Options

### Injection Molded End Cap (IEC)

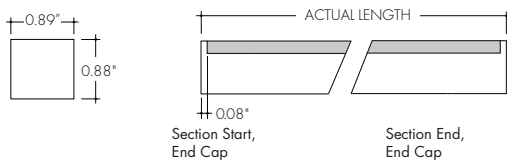

### Injection Molded Bottom Power Feed (IBPF)

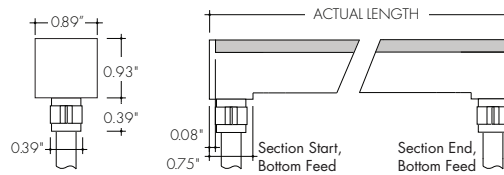

### Injection Molded End Power Feed (IEPF)

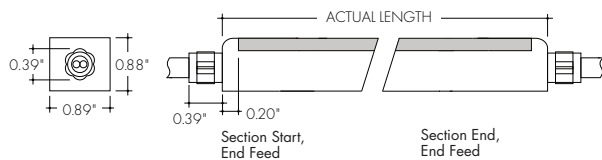

### Injection Molded Side Power Feed (ISPF)

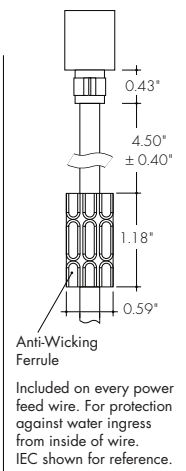
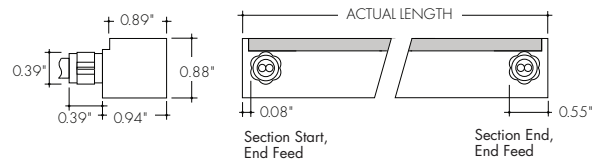

## Ordering Code

MODEL	CCT	SECTION START	SECTION END	ACTUAL LENGTH
KBX-SF-H - Kurba Max, Flat, Horizontal/Side Bend KBX-SF-H-HO - Kurba Max, Flat, Horizontal/Side Bend, High Output	22K - 2200K 27K - 2700K 30K - 3000K 35K - 3500K 40K - 4000K	IEC - Injection Molded End cap <sup>1</sup> IEPF - Injection Molded End power feed (9' wire lead) <sup>1</sup> IBPF - Injection Molded Bottom power feed (9' wire lead) <sup>1</sup> ISPF - Injection Molded Side power feed (9' wire lead) <sup>1, 2</sup>	IEC - Injection Molded End cap <sup>1</sup> IEPF - Injection Molded End power feed (9' wire lead) <sup>1</sup> IBPF - Injection Molded Bottom power feed (9' wire lead) <sup>1</sup> ISPF - Injection Molded Side power feed (9' wire lead) <sup>1, 2</sup>	See Power Consumption table on page 3 for available lengths.

1 - 6-8 weeks lead time. Kurba injected-molded orders are non-cancellable. IEPF, IBPF, ISPF cannot be mixed and matched from Start to End except with IEC.

2 - ISPF Side power feeds selected for both Section Start and End will be located on the same side of the strip.

Mounting Accessories & Optional Connectors

**MC-NFS-KBX-F-78**

Mounting Channel with Grip, 78"

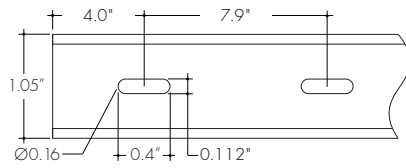
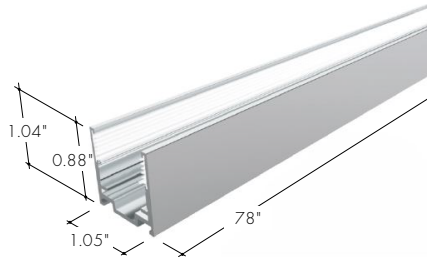

Aluminum mounting channel providing grip. For use with light strip mounted to the ceiling.

**MB-KBX-F-ST**

Mounting Bracket with Grip, 78"

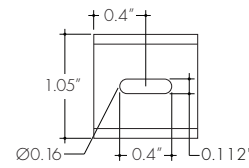
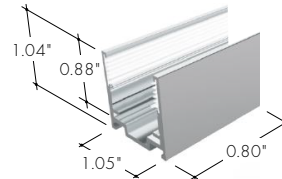

Aluminum mounting bracket providing grip. For use with light strip mounted to the ceiling. 1 recommended every 8 in.

**LVSP-WET**

Splice Box

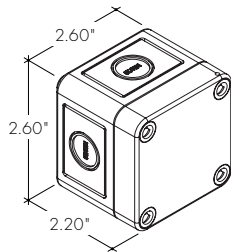

Wet rated, low voltage splice box, gray.

**LVSP-WET-CM**

Connector

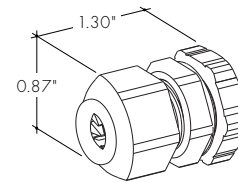

Low voltage splice box wet cable management, gray.

**Power Consumption Per Fixture Length**

Based on operation with PDCU series of power supplies. Use Actual Length for Order Code Entry  
 Tolerance for Actual Lengths less than 6 ft is +/- 0.2", Actual Lengths between 6 ft and 16 ft is +/- 0.3", and Actual Lengths greater than 16 ft is +/- 0.6"

**Kurba Max Horizontal Standard Output (KBX-SF-H)**

Actual Length (in)					Actual Length (in)					Actual Length (in)					Actual Length (in)				
Nominal Length (in)	W	IEPF IEPF	IEC IEPF	IEC IBPF ISPF	Nominal Length (in)	W	IEPF IEPF	IEC IEPF	IEC IBPF ISPF	Nominal Length (in)	W	IEPF IEPF	IEC IEPF	IEC IBPF ISPF	Nominal Length (in)	W	IEPF IEPF	IEC IEPF	IEC IBPF ISPF
2	-	-	-	-	65	27.4	<b>65.4</b>	<b>65.2</b>	<b>65.1</b>	128	53.8	<b>128.4</b>	<b>128.2</b>	<b>128.1</b>	195	81.9	<b>195.3</b>	<b>195.2</b>	<b>195</b>
4	-	-	-	-	67	28.2	<b>67.3</b>	<b>67.2</b>	<b>67.1</b>	130	54.6	<b>130.3</b>	<b>130.2</b>	<b>130.1</b>	197	82.7	<b>197.3</b>	<b>197.1</b>	<b>197</b>
6	2.6	<b>6.3</b>	<b>6.2</b>	<b>6.1</b>	69	29.1	<b>69.3</b>	<b>69.2</b>	<b>69.1</b>	(11 ft) 132	55.5	<b>132.3</b>	<b>132.2</b>	<b>132</b>	199	83.5	<b>199.2</b>	<b>199.1</b>	<b>199</b>
8	3.5	<b>8.3</b>	<b>8.2</b>	<b>8</b>	(6 ft) 71	29.9	<b>71.3</b>	<b>71.1</b>	<b>71</b>	134	56.3	<b>134.3</b>	<b>134.1</b>	<b>134</b>	201	84.3	<b>201.2</b>	<b>201.1</b>	<b>200.9</b>
10	4.3	<b>10.2</b>	<b>10.1</b>	<b>10</b>	73	30.7	<b>73.2</b>	<b>73.1</b>	<b>73</b>	140	58.8	<b>140.2</b>	<b>140</b>	<b>139.9</b>	199	83.5	<b>199.2</b>	<b>199.1</b>	<b>199</b>
(1 ft) 12	5.1	<b>12.2</b>	<b>12.1</b>	<b>12</b>	75	31.5	<b>75.2</b>	<b>75.1</b>	<b>75</b>	142	59.6	<b>142.1</b>	<b>142</b>	<b>141.9</b>	201	84.3	<b>201.2</b>	<b>201.1</b>	<b>200.9</b>
14	5.9	<b>14.2</b>	<b>14.1</b>	<b>13.9</b>	77	32.4	<b>77.2</b>	<b>77.1</b>	<b>76.9</b>	(12 ft) 144	60.4	<b>144.1</b>	<b>144</b>	<b>143.9</b>	(17 ft) 203	85.2	<b>203.2</b>	<b>203</b>	<b>202.9</b>
16	6.8	<b>16.1</b>	<b>16</b>	<b>15.9</b>	79	33.2	<b>79.1</b>	<b>79</b>	<b>78.9</b>	146	61.2	<b>146.1</b>	<b>145.9</b>	<b>145.8</b>	205	86	<b>205.1</b>	<b>205</b>	<b>204.9</b>
18	7.6	<b>18.1</b>	<b>18</b>	<b>17.9</b>	81	34	<b>81.1</b>	<b>81</b>	<b>80.9</b>	148	62.1	<b>148</b>	<b>147.9</b>	<b>147.8</b>	207	86.8	<b>207.1</b>	<b>207</b>	<b>206.9</b>
20	8.4	<b>20.1</b>	<b>20</b>	<b>19.8</b>	(7 ft) 83	34.8	<b>83.1</b>	<b>83</b>	<b>82.8</b>	150	62.9	<b>150</b>	<b>149.9</b>	<b>149.8</b>	209	87.6	<b>209.1</b>	<b>208.9</b>	<b>208.8</b>
22	9.2	<b>22.1</b>	<b>21.9</b>	<b>21.8</b>	85	35.7	<b>85</b>	<b>84.9</b>	<b>84.8</b>	152	63.7	<b>152</b>	<b>151.9</b>	<b>151.7</b>	211	88.5	<b>211</b>	<b>210.9</b>	<b>210.8</b>
(2 ft) 24	10.1	<b>24</b>	<b>23.9</b>	<b>23.8</b>	87	36.5	<b>87</b>	<b>86.9</b>	<b>86.8</b>	154	64.5	<b>153.9</b>	<b>153.8</b>	<b>153.7</b>	213	89.3	<b>213</b>	<b>212.9</b>	<b>212.8</b>
26	10.9	<b>26</b>	<b>25.9</b>	<b>25.8</b>	89	37.3	<b>89</b>	<b>88.9</b>	<b>88.7</b>	(13 ft) 156	65.4	<b>155.9</b>	<b>155.8</b>	<b>155.7</b>	215	90.1	<b>215</b>	<b>214.8</b>	<b>214.7</b>
28	11.7	<b>28</b>	<b>27.8</b>	<b>27.7</b>	91	38.1	<b>91</b>	<b>90.8</b>	<b>90.7</b>	158	66.2	<b>157.9</b>	<b>157.8</b>	<b>157.6</b>	(18 ft) 217	90.9	<b>216.9</b>	<b>216.8</b>	<b>216.7</b>
30	12.5	<b>29.9</b>	<b>29.8</b>	<b>29.7</b>	93	39	<b>92.9</b>	<b>92.8</b>	<b>92.7</b>	160	67	<b>159.8</b>	<b>159.7</b>	<b>159.6</b>					
32	13.4	<b>31.9</b>	<b>31.8</b>	<b>31.7</b>	95	39.8	<b>94.9</b>	<b>94.8</b>	<b>94.6</b>	162	67.8	<b>161.8</b>	<b>161.7</b>	<b>161.6</b>					
34	14.2	<b>33.9</b>	<b>33.7</b>	<b>33.6</b>	(8 ft) 97	40.6	<b>96.9</b>	<b>96.7</b>	<b>96.6</b>	164	68.7	<b>163.8</b>	<b>163.7</b>	<b>163.5</b>					
(3 ft) 36	15	<b>35.8</b>	<b>35.7</b>	<b>35.6</b>	99	41.4	<b>98.8</b>	<b>98.7</b>	<b>98.6</b>	166	69.5	<b>165.8</b>	<b>165.6</b>	<b>165.5</b>					
38	15.8	<b>37.8</b>	<b>37.7</b>	<b>37.6</b>	101	42.3	<b>100.8</b>	<b>100.7</b>	<b>100.6</b>	(14 ft) 168	70.3	<b>167.7</b>	<b>167.6</b>	<b>167.5</b>					
40	16.7	<b>39.8</b>	<b>39.7</b>	<b>39.5</b>	103	43.1	<b>102.8</b>	<b>102.6</b>	<b>102.5</b>	170	71.1	<b>169.7</b>	<b>169.6</b>	<b>169.5</b>					
42	17.5	<b>41.7</b>	<b>41.6</b>	<b>41.5</b>	105	43.9	<b>104.7</b>	<b>104.6</b>	<b>104.5</b>	172	72	<b>171.7</b>	<b>171.5</b>	<b>171.4</b>					
44	18.3	<b>43.7</b>	<b>43.6</b>	<b>43.5</b>	107	44.7	<b>106.7</b>	<b>106.6</b>	<b>106.5</b>	174	72.8	<b>173.6</b>	<b>173.5</b>	<b>173.4</b>					
46	19.1	<b>45.7</b>	<b>45.6</b>	<b>45.4</b>	(9 ft) 109	45.6	<b>108.7</b>	<b>108.5</b>	<b>108.4</b>	176	73.6	<b>175.6</b>	<b>175.5</b>	<b>175.4</b>					
(4 ft) 48	20	<b>47.6</b>	<b>47.5</b>	<b>47.4</b>	111	46.4	<b>110.6</b>	<b>110.5</b>	<b>110.4</b>	178	74.4	<b>177.6</b>	<b>177.4</b>	<b>177.3</b>					
50	20.8	<b>49.6</b>	<b>49.5</b>	<b>49.4</b>	113	47.2	<b>112.6</b>	<b>112.5</b>	<b>112.4</b>	(15 ft) 180	75.3	<b>179.5</b>	<b>179.4</b>	<b>179.3</b>					
52	21.6	<b>51.6</b>	<b>51.5</b>	<b>51.3</b>	115	48	<b>114.6</b>	<b>114.5</b>	<b>114.3</b>	182	76.1	<b>181.5</b>	<b>181.4</b>	<b>181.3</b>					
54	22.4	<b>53.5</b>	<b>53.4</b>	<b>53.3</b>	117	48.9	<b>116.5</b>	<b>116.4</b>	<b>116.3</b>	183	76.9	<b>183.5</b>	<b>183.4</b>	<b>183.2</b>					
56	23.3	<b>55.5</b>	<b>55.4</b>	<b>55.3</b>	119	49.7	<b>118.5</b>	<b>118.4</b>	<b>118.3</b>	185	77.7	<b>185.4</b>	<b>185.3</b>	<b>185.2</b>					
57	24.1	<b>57.5</b>	<b>57.4</b>	<b>57.2</b>	(10 ft) 120	50.5	<b>120.5</b>	<b>120.4</b>	<b>120.2</b>	187	78.6	<b>187.4</b>	<b>187.3</b>	<b>187.2</b>					
(5 ft) 59	24.9	<b>59.5</b>	<b>59.3</b>	<b>59.2</b>	122	51.3	<b>122.4</b>	<b>122.3</b>	<b>122.2</b>	189	79.4	<b>189.4</b>	<b>189.3</b>	<b>189.1</b>					
61	25.7	<b>61.4</b>	<b>61.3</b>	<b>61.2</b>	124	52.2	<b>124.4</b>	<b>124.3</b>	<b>124.2</b>	(16 ft) 191	80.2	<b>191.3</b>	<b>191.2</b>	<b>191.1</b>					
63	26.6	<b>63.4</b>	<b>63.3</b>	<b>63.2</b>	126	53	<b>126.4</b>	<b>126.3</b>	<b>126.1</b>	193	81	<b>193.3</b>	<b>193.2</b>	<b>193.1</b>					

Injection Molded End Cap (IEC)

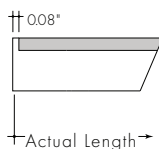

Injection Molded End Power Feed (IEPF)

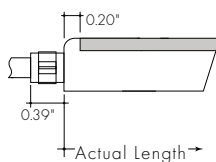

Injection Molded Bottom Power Feed (IBPF)

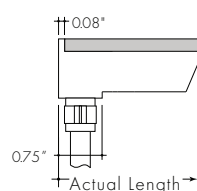

Injection Molded Side Power Feed (ISPF)

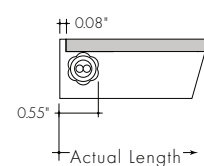

**Power Consumption Per Fixture Length**

Based on operation with PDCU series of power supplies. Use Actual Length for Order Code Entry  
 Tolerance for Actual Lengths less than 6 ft is +/- 0.2", Actual Lengths between 6 ft and 16 ft is +/- 0.3", and Actual Lengths greater than 16 ft is +/- 0.6"

**Kurba Max Horizontal High Output (KBX-SF-H-HO)**

Nominal Length (in)	W	Actual Length (in)			Nominal Length (in)	W	Actual Length (in)			Nominal Length (in)	W	Actual Length (in)		
		IEPF IEPF	IEC IEPF	IEC IBFP ISPF			IEPF IEPF	IEC IEPF	IEC IBFP ISPF			IEPF IEPF	IEC IEPF	IEC IBFP ISPF
2	-	-	-	-	75	31.3	<b>74.8</b>	<b>74.7</b>	<b>74.5</b>	147	61.6	<b>147.0</b>	<b>146.8</b>	<b>146.7</b>
4	-	-	-	-	77	32.3	<b>77.0</b>	<b>76.8</b>	<b>76.7</b>	149	62.5	<b>149.1</b>	<b>149.0</b>	<b>148.9</b>
7	2.9	<b>7.0</b>	<b>6.8</b>	<b>6.7</b>	79	33.2	<b>79.1</b>	<b>79.0</b>	<b>78.9</b>	151	63.4	<b>151.3</b>	<b>151.2</b>	<b>151.1</b>
9	3.8	<b>9.1</b>	<b>9.0</b>	<b>8.9</b>	81	34.1	<b>81.3</b>	<b>81.2</b>	<b>81.1</b>	(13 ft) 156	64.4	<b>153.5</b>	<b>153.4</b>	<b>153.3</b>
(1 ft) 11	4.8	<b>11.3</b>	<b>11.2</b>	<b>11.1</b>	(7 ft) 84	35.0	<b>83.5</b>	<b>83.4</b>	<b>83.3</b>	158	65.3	<b>155.7</b>	<b>155.6</b>	<b>155.5</b>
14	5.7	<b>13.5</b>	<b>13.4</b>	<b>13.3</b>	86	35.9	<b>85.7</b>	<b>85.6</b>	<b>85.5</b>	160	66.2	<b>157.9</b>	<b>157.8</b>	<b>157.7</b>
16	6.6	<b>15.7</b>	<b>15.6</b>	<b>15.5</b>	88	36.8	<b>87.9</b>	<b>87.8</b>	<b>87.7</b>	162	67.1	<b>160.1</b>	<b>160.0</b>	<b>159.8</b>
18	7.5	<b>17.9</b>	<b>17.8</b>	<b>17.7</b>	90	37.8	<b>90.1</b>	<b>90.0</b>	<b>89.8</b>	165	68.0	<b>162.3</b>	<b>162.1</b>	<b>162.0</b>
20	8.4	<b>20.1</b>	<b>20.0</b>	<b>19.8</b>	92	38.7	<b>92.3</b>	<b>92.2</b>	<b>92.0</b>	(14 ft) 167	68.9	<b>164.5</b>	<b>164.3</b>	<b>164.2</b>
22	9.3	<b>22.3</b>	<b>22.2</b>	<b>22.0</b>	(8 ft) 95	39.6	<b>94.5</b>	<b>94.3</b>	<b>94.2</b>	169	69.9	<b>166.6</b>	<b>166.5</b>	<b>166.4</b>
(2 ft) 24	10.3	<b>24.5</b>	<b>24.3</b>	<b>24.2</b>	97	40.5	<b>96.6</b>	<b>96.5</b>	<b>96.4</b>	171	70.8	<b>168.8</b>	<b>168.7</b>	<b>168.6</b>
27	11.2	<b>26.6</b>	<b>26.5</b>	<b>26.4</b>	99	41.4	<b>98.8</b>	<b>98.7</b>	<b>98.6</b>	173	71.7	<b>171.0</b>	<b>170.9</b>	<b>170.8</b>
29	12.1	<b>28.8</b>	<b>28.7</b>	<b>28.6</b>	101	42.3	<b>101.0</b>	<b>100.9</b>	<b>100.8</b>	176	72.6	<b>173.2</b>	<b>173.1</b>	<b>173.0</b>
31	13.0	<b>31.0</b>	<b>30.9</b>	<b>30.8</b>	103	43.3	<b>103.2</b>	<b>103.1</b>	<b>103.0</b>	178	73.5	<b>175.4</b>	<b>175.3</b>	<b>175.2</b>
33	13.9	<b>33.2</b>	<b>33.1</b>	<b>33.0</b>	105	44.2	<b>105.4</b>	<b>105.3</b>	<b>105.2</b>	(15 ft) 180	74.4	<b>177.6</b>	<b>177.5</b>	<b>177.3</b>
(3 ft) 35	14.8	<b>35.4</b>	<b>35.3</b>	<b>35.2</b>	(9 ft) 108	45.1	<b>107.6</b>	<b>107.5</b>	<b>107.3</b>	182	75.4	<b>179.8</b>	<b>179.6</b>	<b>179.5</b>
38	15.8	<b>37.6</b>	<b>37.5</b>	<b>37.3</b>	110	46.0	<b>109.8</b>	<b>109.7</b>	<b>109.5</b>	184	76.3	<b>182.0</b>	<b>181.8</b>	<b>181.7</b>
40	16.7	<b>39.8</b>	<b>39.7</b>	<b>39.5</b>	112	46.9	<b>112.0</b>	<b>111.8</b>	<b>111.7</b>	186	77.2	<b>184.1</b>	<b>184.0</b>	<b>183.9</b>
42	17.6	<b>42.0</b>	<b>41.8</b>	<b>41.7</b>	114	47.9	<b>114.1</b>	<b>114.0</b>	<b>113.9</b>	189	78.1	<b>186.3</b>	<b>186.2</b>	<b>186.1</b>
44	18.5	<b>44.1</b>	<b>44.0</b>	<b>43.9</b>	116	48.8	<b>116.3</b>	<b>116.2</b>	<b>116.1</b>	(16 ft) 191	79.0	<b>188.5</b>	<b>188.4</b>	<b>188.3</b>
(4 ft) 46	19.4	<b>46.3</b>	<b>46.2</b>	<b>46.1</b>	(10 ft) 119	49.7	<b>118.5</b>	<b>118.4</b>	<b>118.3</b>	193	79.9	<b>190.7</b>	<b>190.6</b>	<b>190.5</b>
49	20.3	<b>48.5</b>	<b>48.4</b>	<b>48.3</b>	121	50.6	<b>120.7</b>	<b>120.6</b>	<b>120.5</b>	195	80.9	<b>192.9</b>	<b>192.8</b>	<b>192.7</b>
51	21.3	<b>50.7</b>	<b>50.6</b>	<b>50.5</b>	123	51.5	<b>122.9</b>	<b>122.8</b>	<b>122.7</b>	197	81.8	<b>195.1</b>	<b>195.0</b>	<b>194.8</b>
53	22.2	<b>52.9</b>	<b>52.8</b>	<b>52.7</b>	125	52.4	<b>125.1</b>	<b>125.0</b>	<b>124.8</b>	200	82.7	<b>197.3</b>	<b>197.1</b>	<b>197.0</b>
55	23.1	<b>55.1</b>	<b>55.0</b>	<b>54.8</b>	127	53.4	<b>127.3</b>	<b>127.1</b>	<b>127.0</b>	202	83.6	<b>199.5</b>	<b>199.3</b>	<b>199.2</b>
57	24.0	<b>57.3</b>	<b>57.2</b>	<b>57.0</b>	130	54.3	<b>129.5</b>	<b>129.3</b>	<b>129.2</b>	(17 ft) 204	84.5	<b>201.6</b>	<b>201.5</b>	<b>201.4</b>
(5 ft) 60	24.9	<b>59.5</b>	<b>59.3</b>	<b>59.2</b>	(11 ft) 132	55.2	<b>131.6</b>	<b>131.5</b>	<b>131.4</b>	206	85.4	<b>203.8</b>	<b>203.7</b>	<b>203.6</b>
62	25.8	<b>61.6</b>	<b>61.5</b>	<b>61.4</b>	134	56.1	<b>133.8</b>	<b>133.7</b>	<b>133.6</b>	208	86.4	<b>206.0</b>	<b>205.9</b>	<b>205.8</b>
64	26.8	<b>63.8</b>	<b>63.7</b>	<b>63.6</b>	136	57.0	<b>136.0</b>	<b>135.9</b>	<b>135.8</b>	211	87.3	<b>208.2</b>	<b>208.1</b>	<b>208.0</b>
66	27.7	<b>66.0</b>	<b>65.9</b>	<b>65.8</b>	138	57.9	<b>138.2</b>	<b>138.1</b>	<b>138.0</b>	213	88.2	<b>210.4</b>	<b>210.3</b>	<b>210.2</b>
68	28.6	<b>68.2</b>	<b>68.1</b>	<b>68.0</b>	140	58.9	<b>140.4</b>	<b>140.3</b>	<b>140.2</b>	(18 ft) 215	89.1	<b>212.6</b>	<b>212.5</b>	<b>212.3</b>
(6 ft) 70	29.5	<b>70.4</b>	<b>70.3</b>	<b>70.2</b>	(12 ft) 143	59.8	<b>142.6</b>	<b>142.5</b>	<b>142.3</b>	98	90.0	<b>214.8</b>	<b>214.6</b>	<b>214.5</b>
73	30.4	<b>72.6</b>	<b>72.5</b>	<b>72.3</b>	145	60.7	<b>144.8</b>	<b>144.6</b>	<b>144.5</b>					

Injection Molded End Cap (IEC)

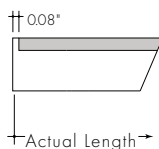

Injection Molded End Power Feed (IEPF)

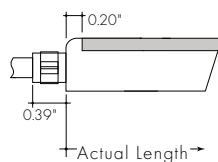

Injection Molded Bottom Power Feed (IBPF)

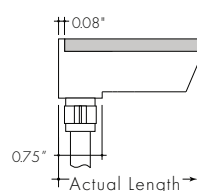

Injection Molded Side Power Feed (ISPF)

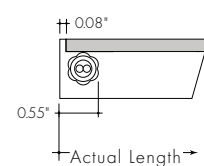

## Power Supplies

See Power Supply instructions and spec sheet for wiring information. For a complete list of compatible dimmers, see Compatible Dimming Chart on the Resources page.

### Universal Power Supply 1% 120VAC - 277VAC

MODEL	POWER	OUTPUT
PDCU-D - IP20 Dry Series	30 - 30 W 60 - 60 W 96 - 96 W 3X96 - 3X96 W	24 - 24 VDC
PDCU-W - IP66 Wet Series	96 - 96 W 3X96 - 3X96 W	

0-10V dims down to 1%, MLV/ELV/TRIAC dims down to 1%.  
For a complete list of compatible dimmers, see [Compatible Dimming Chart](#) on the Resources page.

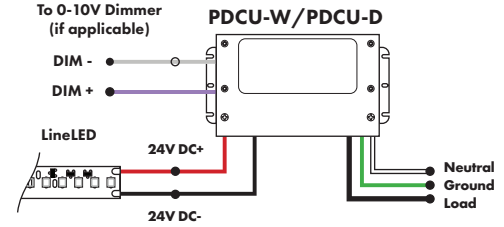

MODELS	PDCU-W 96W	PDCU-W 3X96W	PDCU-D 30W	PDCU-D 60W	PDCU-D 96W	PDCU-D 3X96W
<b>Length</b>	8.66"	11.85"	6.10"	7.93"	8.25"	9.57"
<b>Width</b>	3.73"	4.32"	3.35"	3.35"	4.10"	5.94"
<b>Depth</b>	1.61"	1.81"	1.33"	1.32"	1.56"	1.13"

### 0-10V Dimming Power Supplies 0.1% 120VAC - 277VAC

MODEL	POWER	OUTPUT	DIMMING
PSO10V - 0-10V Power Supply dims down to 0.1%	96 - 96 Watt 3X96 - 3 X 96 Watt	24 - 24 VDC	LIN - Linear LOG - Logarithmic

MODELS	96W	3X96
<b>Length</b>	14.40"	15.75"
<b>Width</b>	5.20"	6.62"
<b>Depth</b>	2.60"	4.95"

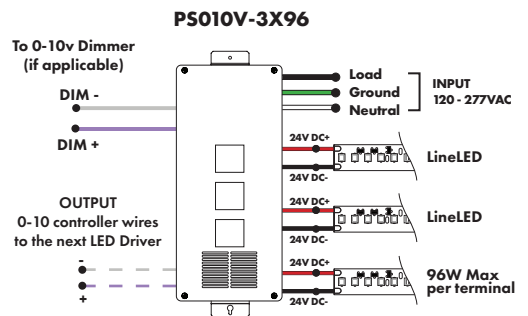
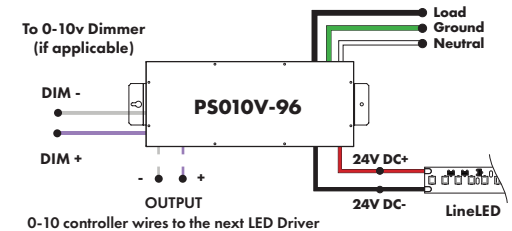

### Triac, MLV, & ELV Compatible Dimmers

MODEL	POWER	OUTPUT
PDC - (IP20) Power Supply	96 - 96 Watts	24 - 24 VDC

MODELS	96W
<b>Length</b>	8.25"
<b>Width</b>	4.10"
<b>Depth</b>	1.56"

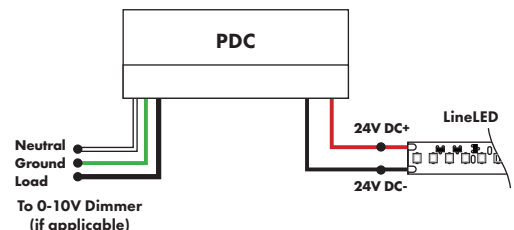

## Power Supplies

See Power Supply instructions and spec sheet for wiring information. For a complete list of compatible dimmers, see Compatible Dimming Chart on the Resources page.

### DMX Dimming Power Supplies 120VAC - 277VAC

MODEL	POWER	OUTPUT
PSDMX - DMX Power Supply dims down to 0%	96 - 96 Watt 3X96 - 3 X 96 Watt	24 - 24 VDC

Features eldoLED's LINEARdrive configurable dimmable drivers

MODELS	96W	3X96
<b>Length</b>	14.40"	15.75"
<b>Width</b>	5.20"	6.62"
<b>Depth</b>	2.60"	4.95"

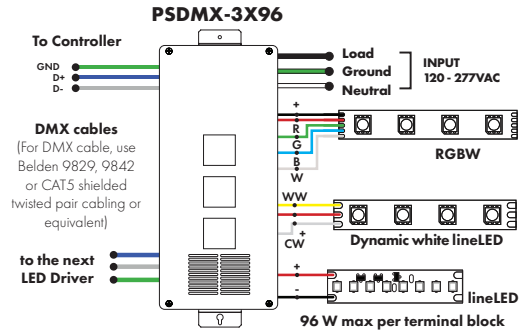
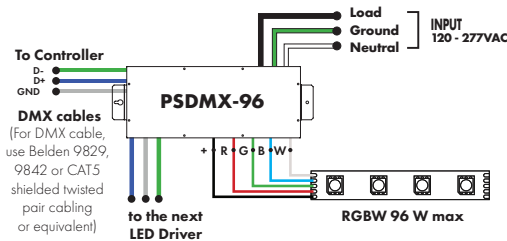

### DALI 0% Dimming Power Supplies 120VAC - 277VAC

MODEL	POWER	OUTPUT
PSDALI - DALI Power Supply dims down to 0%	96 - 96 Watt 3X96 - 3 X 96 Watt	24 - 24 VDC

Features eldoLED's LINEARdrive configurable dimmable drivers

Model	96W	3X96
<b>Length</b>	14.40"	15.75"
<b>Width</b>	5.20"	6.62"
<b>Depth</b>	2.60"	4.95"

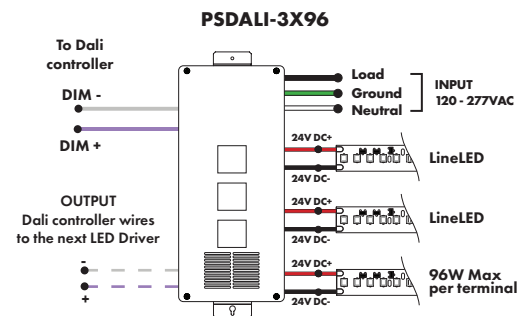
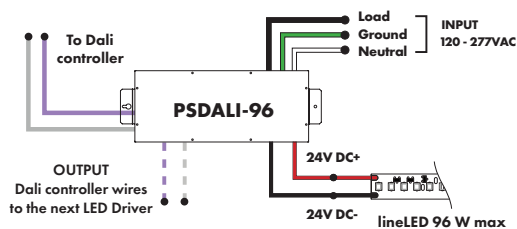

### Enlighted Enabled Dimming Power Supplies 120VAC - 277VAC

MODEL	POWER	OUTPUT	DIMMING	LOCATION
PSV - PSV Series	96 - 96 Watt	24 - 24 VDC	ENL - Enlighted Dimming dims down to 0%	D - Damp

Model	96W
<b>Length</b>	14.40"
<b>Width</b>	5.20"
<b>Depth</b>	2.60"

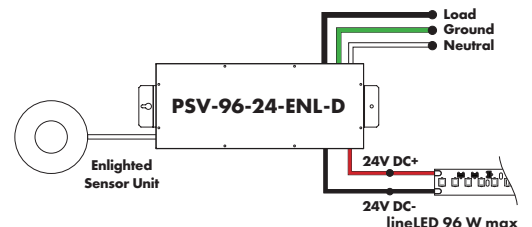

## Power Supplies

See Power Supply instructions and spec sheet for wiring information. For a complete list of compatible dimmers, see Compatible Dimming Chart on the Resources page.

### Non-Dimming Power Supply 120VAC - 277VAC

MODEL	POWER	OUTPUT	DIMMING	LOCATION
PSV - PSV Series	96 - 96 Watt	24 - 24 VDC	ND - Non Dimming	D - Damp

MODELS	96W
Length	14.40"
Width	5.20"
Depth	2.60"

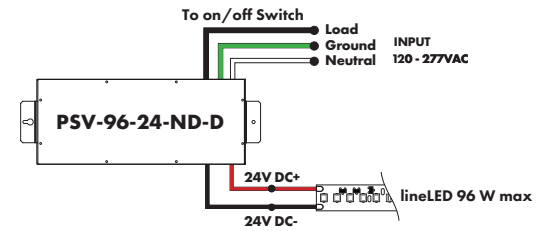

Luminii is a Lutron OEM Advantage Partner

### Lutron Power Supplies 1%

MODEL
L3DA4U1UKL-CV240

HiLume™ 1% EcoSystem Voltage LED driver  
40W max

MODELS	L3DA4U1UKL-CV240
Length	4.98"
Width	4.00"
Depth	2.62"

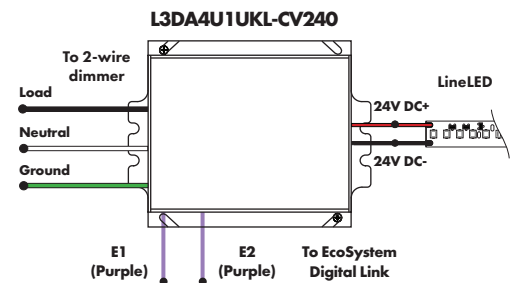

Luminii is a Lutron OEM Advantage Partner

### Lutron Power Supplies 0.1%

MODEL
L3D0-96W24V-U

HiLume™ 0.1% EcoSystem Voltage LED Driver with Soft-On, Fade-to-Black™  
96W max

MODELS	L3D0
Length	10.50"
Width	5.50"
Depth	2.00"

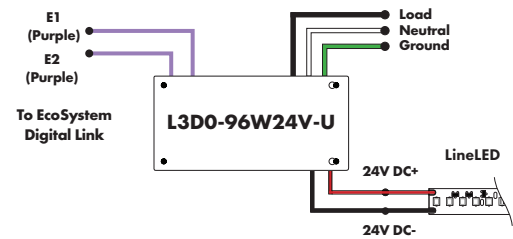

### In-Ground Power Supplies

MODEL	POWER	OUTPUT	INPUT
IG - In ground CVE Series	CVE - ELV Dimming DALI - eldoLED Dali dimming Both dims down to 0%	96X2 - 2 X 96 Watt	24 - 24 VDC
			Blank - 120 V 277 - 240/277 V

MODELS	Dual Circuit
Length	8.40"
Width	8.30"
Depth	8.10"

