

The K45V Channel is a linear aluminum extrusion that has been designed to fit many LED lighting needs and specifically corner applications. Multiple configuration options allow for great flexibility in any installation. Substantial aluminum mass in profile provides excellent heat sink for high power LEDs. K45V Channel is available with frosted lens. Extrusion and lenses are field cuttable. Mounting bracket and end-caps can be ordered separately (page 2).

### Finish

- Silver anodized
- White

### Mounting

Mounting bracket

### Diffuser lens

- Polycarbonate
- Snap-in-place,
- UV resistant



## Product dimensions

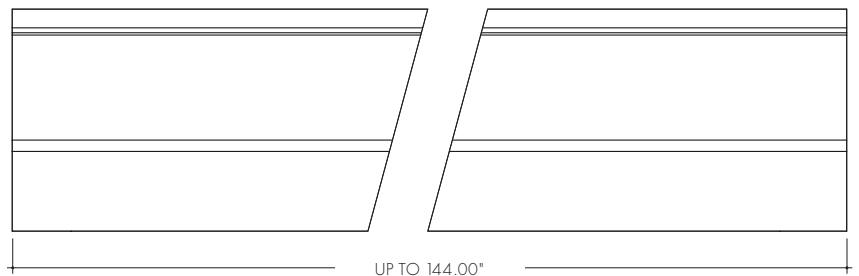
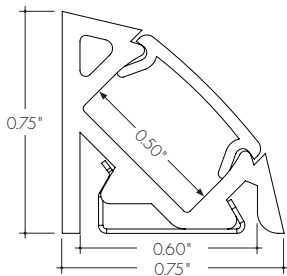

Lens	
Actual Length	48", 72", 96", & 144"
Available Lens	<ul style="list-style-type: none"> <li>• Clear</li> <li>• Frosted</li> <li>• Half Frosted</li> <li>• Clear 10° beam angle</li> <li>• Flat Frosted Gel</li> </ul>

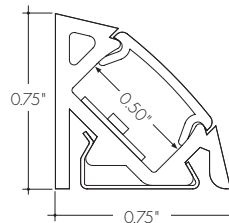

Clear, Frosted, & Half Frosted lens

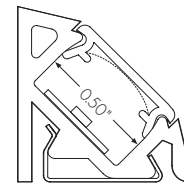

Flat Frosted Gel Lens

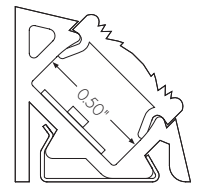

Clear 10° Lens

## Ordering code

MODEL	LENGTH	LENS	FINISH
<b>K45VC</b>	<b>48</b>	<b>C</b>	<b>SA</b>
K45VC - K45V Channel	48 - 48" 72 - 72" 96 - 96" 144 - 144"	C - Clear F - Frosted HF - Half Frosted C10 - Clear 10° beam angle FFG - Flat Frosted Gel	SA - Silver anodized WH - White

NOTE: For Channels and Lenses over 90", incremental shipping charges will apply

All accessories sold separately.

**Mounting Bracket**

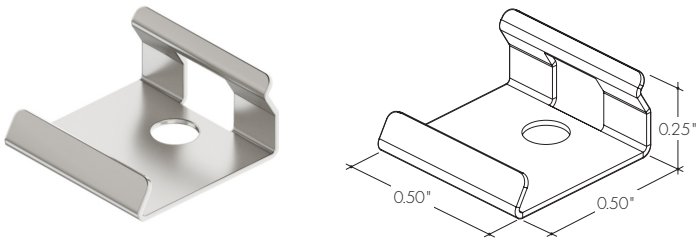

ORDERING CODE

**MB-K45VC-SS**

**MB-K45VC-SS** - Stainles steel screw-in mounting bracket

**End Caps**

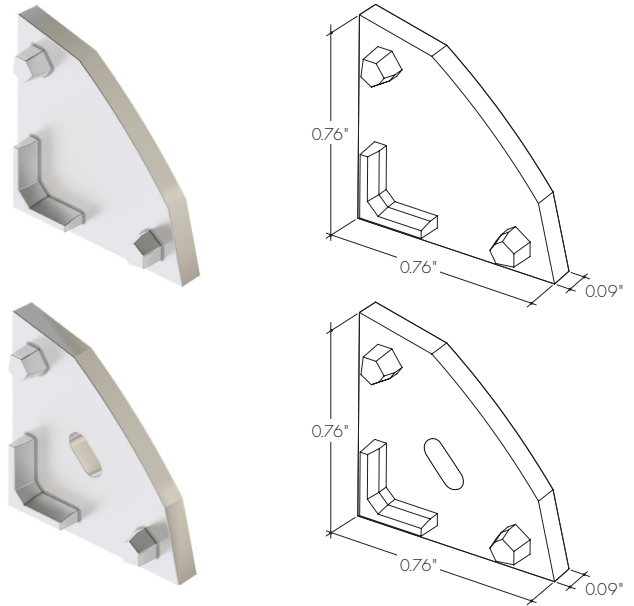

ORDERING CODE

**EC** - **K45VC** - **H3** - **SA**

**EC-K45VC** - K45V Channel End Cap

**H3** - w/o hole  
**H4** - w/hole

**SA** - Silver Anodized  
**WH** - White

