

GLADIUS



Gladius - Linear LED Lighting. The Gladius, with its round section, is designed for applications where the profile is mounted with a distance relative to the mounting surface.

Ordering Code

Fixture	555	715					
	1	2	3	4	5	6	7

Product Specifications

SAMPLE : Fixture 555 - 715 - 500 - LO - 27 - E36 - 6'

1 - Type	2 - Model	3 - Lens	4 - LED Style*1	
555 · Profile	715 · Gladius	504 · Round Frosted	Static White LO1W · LLHE48LO-1W 1 Watt LO · LLHE48LO Low Output SO · LLHE48SO Standard Output MO · LLHE48MO Medium Output 271 · 271 Style LED Strip	Dynamic Color*2 DWSO · LLDW68SO Dynamic White Standard Output DWHO · LLDW68HO Dynamic White High Output RGBSO · LLRGB42SO Color changing Standard Output RGBWSO · LL-RGBW36-SO Color changing Standard Output
5 - CCT		6 - Feed Length	7 - Fixture Length*1	
Static White 22 · 2200K 25 · 2500K 27 · 2700K 30 · 3000K 35 · 3500K 40 · 4000K 50 · 5000K	Dynamic Color*2 1935 · 1900K - 3500K*3 98 · RGB Color changing 99 · RGB+W Color changing	B36 · 36" Back Fed E36 · 36" End Fed BXX · Custom Back Fed EXX · Custom End Fed	XX · Custom (XX.XX") <i>Continuous runs will be made in equal sections no more than 8' long</i> NOTE: For Channels and Lenses over 90", incremental shipping charges will apply	
			*1 Refer to page 2 for LED cut length intervals and available CCT *2 DMX driver required *3 Please ask about different CCT ranges Project : _____ Quantity : _____ Type : _____ Notes : _____	

LED Technical Information

	STYLE	WATT/FT	DELIVERED LM/FT FROSTED	CRI	MAX. LENGTH	Color TEMPERATURE
Static White	LLHE48LO-1W	1.0	84	92	60'	2200K, 2500K, 2700K, 3000K, 3500K, 4000K
	LLHE48LO	1.9	169	92	48'	
	LLHE48SO	2.8	242	92	42'	
	LLHE48MO	3.5	323	92	33'	
	271	7.3	588	90	9.8'	2700K, 3000K, 3500K, 4000K, 5000K
Dynamic Color	LLDW68SO-1935	4.1	312	95	32'	1900K - 3500K
	LLDW68HO-1935	5.2	287	96	32'	
	LLRGB42SO	4.4	109	---	28'	Red/Green/Blue
	LLRGBW36SO	4.1	110	97	26'	Red/Green/Blue White LED 97 CRI / 3000K

* Lumen output calculations based on 3500K.
For LED strip information, See the page for:

LLHE48 [HERE](#).
LLDW68 [HERE](#).
LLRGB42 [HERE](#).
LLRGBW36 [HERE](#)

Lens/Light Distribution

part number **504** (frosted 65% transparent)

- PMMA construction
- Easily clipped in profile
- Comes precut to match profile length
- Flush

Round Frosted Lens

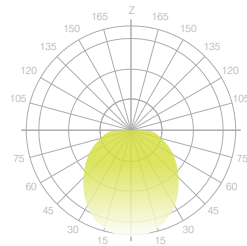

Construction

- Housing: Aluminum extrusion
- Made in Canada

Installation

- Factory assembled for easy and fast installation
- Electrical wire included

Dimensions

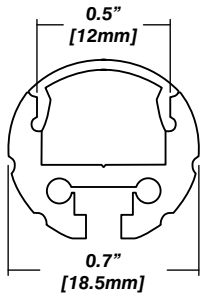

Flush Mount Clip

part number **555-715-20**

- Steel construction
- Profile is mounted flush to surface
- Not visible once installed

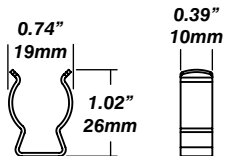

Mounting Magnet

part number **555-915-14**

- Used to install profiles on metallic surfaces
- Profile is mounted flush to surface
- Pre-installed

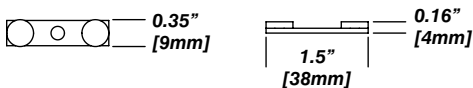

Standard Adjustable Bracket

part number **555-915-11-02** (black)
555-915-11-08 (silver)

- Tilts up to 130°
- Aluminum construction

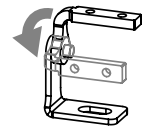
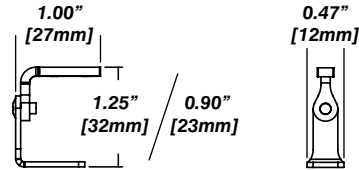

Long Adjustable Bracket

part number **555-915-12-02** (black)
555-915-12-08 (silver)

- Allows the profile to be mounted further from the surface: approx. 3" [75mm] depending on orientation of profile
- Aluminum construction

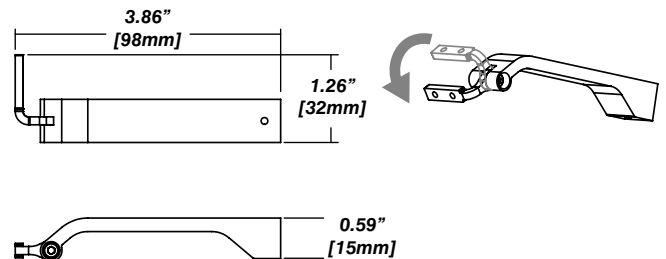

Joining Sections

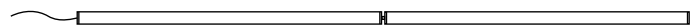

Universal Power Supply 1% 120VAC - 277VAC

Universal Power Supply 1% 120VAC - 277VAC

MODEL	POWER	OUTPUT
PDCU-D - IP20 Dry Series	30 - 30 W 60 - 60 W 96 - 96 W	24 - 24 VDC

PDCU-W - IP66 Wet Series 96 - 96 W

0-10V dims down to 1%, MLV/ELV/TRIAC dims down to 1%.
Contact Senso to specify 347V transformer.
For a complete details on the Universal Power Supply, see Spec Sheet, Compatible Dimming and Install Guide on the [Resources page](#).

MODELS	PDCU-W 96W	PDCU-D 30W	PDCU-D 60W	PDCU-D 96W
Length	8.66"	6.10"	7.93"	8.25"
Width	3.73"	3.35"	3.35"	4.10"
Depth	1.61"	1.33"	1.32"	1.56"

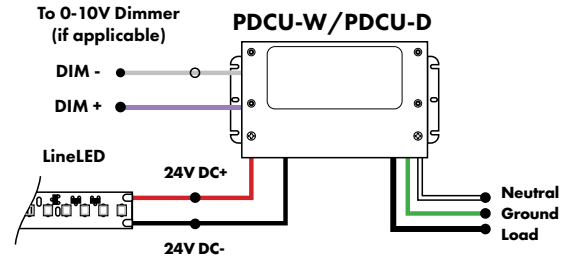

30W/60W 347V Transformer
attaches directly to PDCU box

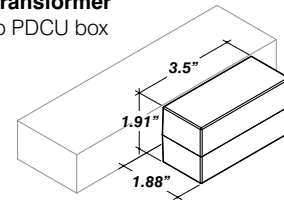

96W 347V Transformer
wired to PDCU box

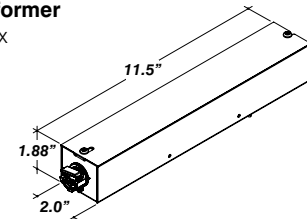

DMX Dimming Power Supply 120VAC - 277VAC

DMX Dimming Power Supplies 120VAC - 277VAC

MODEL	POWER	OUTPUT
PSDMX - DMX Power Supply dims down to 0%	96 - 96 Watt 3X96 - 3 X 96 Watt	24 - 24 VDC

Features eldoLED's LINEARdrive configurable dimmable drivers. For a complete details on the DMX Dimming Power Supply, see Spec Sheet on the [Resources page](#).

MODELS	96W	3X96
Length	14.40"	15.75"
Width	5.20"	6.62"
Depth	2.60"	4.95"

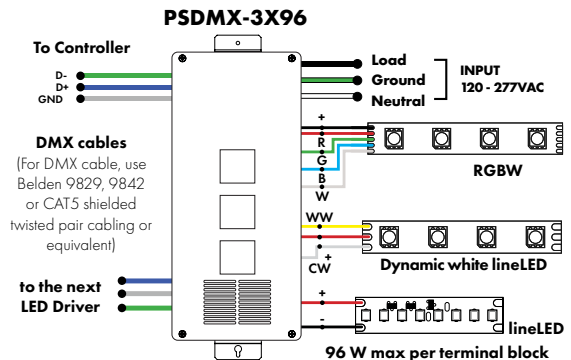
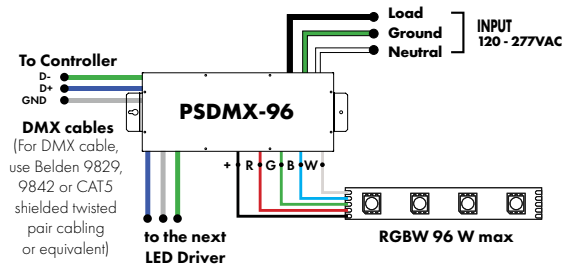

LUTRON®

Luminii is a Lutron OEM Advantage Partner
Lutron Power Supplies 1%

MODEL

LTEA4U1UKL - CV240

Lutron - Hi-lume™ 1% 2-wire LED Driver
40W max

(120V forward phase only)

MODEL

L3DA4U1UKL - CV240

Hi-lume™ 1% EcoSystem Voltage LED driver
40W max

MODELS	LTEA4U1UKL-CV240	L3DA4U1UKL-CV240
Length	4.89"	4.98"
Width	4.00"	4.00"
Depth	2.62"	2.62"

For a complete details on the Lutron Power Supply, see Spec Sheet and Install Guide on the [Resources page](#).

LUTRON®

Luminii is a Lutron OEM Advantage Partner
Lutron Power Supplies 0.1%

MODEL

L3D0-96W24V-U

Hi-lume™ 0.1% EcoSystem Voltage LED Driver with Soft-On, Fade-to-Black™
96W max

MODELS	L3D0
Length	10.50"
Width	5.50"
Depth	2.00"

