

# EXCALIBUR

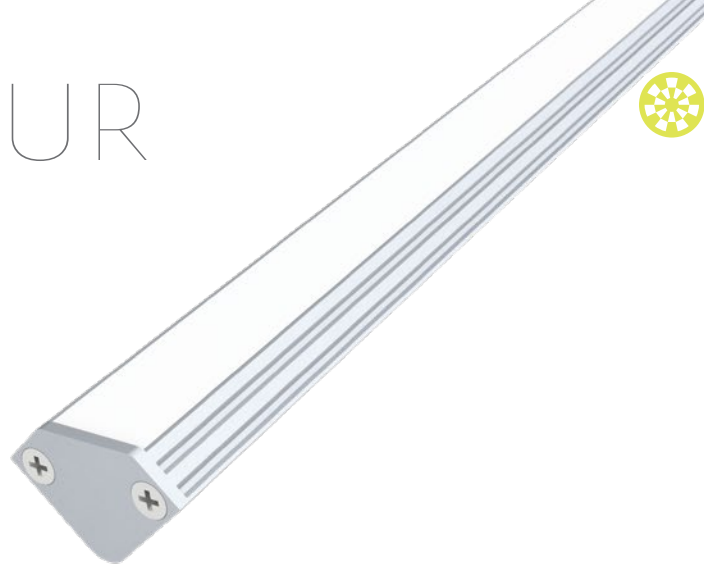

**Excalibur - Linear LED Lighting.** The Excalibur is a 45 degree surface mount profile that allows you to have specific directional light for your applications.

## Ordering Code

|         |            |            |   |   |   |   |   |
|---------|------------|------------|---|---|---|---|---|
| Fixture | <b>555</b> | <b>315</b> |   |   |   |   |   |
|         | 1          | 2          | 3 | 4 | 5 | 6 | 7 |

## Product Specifications

**SAMPLE :** Fixture 555 - 315 - 500 - LO - 27 - E36 - 6'

| 1 - Type  | 2 - Model  | 3 - Lens                                   | 4 - LED Style*1   |  |
|---|--|--|---|--|
| <b>555</b> · Profile  | <b>315</b> · Excalibur   | <b>500</b> · Frosted<br><b>502</b> · Clear | Static White<br><b>L01W</b> · LLHE48LO-1W 1 Watt<br><b>LO</b> · LLHE48LO Low Output<br><b>SO</b> · LLHE48SO Standard Output<br><b>MO</b> · LLHE48MO Medium Output<br><b>HO</b> · LLHE48HO High Output<br><b>271</b> · 271 Style LED Strip<br><b>382</b> · 382 Style LED Strip | Dynamic Color*2<br><b>CT1</b> · Tunable White<br><b>RGB</b> · RGB Color changing<br><b>RGBW</b> · RGB+W Color changing |
| 5 - CCT   | 6 - Feed Point   |  | 7 - Fixture Length*1  |  |
| Static White<br><b>22</b> · 2200K<br><b>25</b> · 2500K<br><b>27</b> · 2700K<br><b>30</b> · 3000K<br><b>35</b> · 3500K<br><b>40</b> · 4000K<br><b>50</b> · 5000K | Dynamic Color*2<br><b>CT</b> · Tunable White<br><b>98</b> · RGB Color changing<br><b>99</b> · RGB+W Color changing |  | <b>B36</b> · 36" Back Fed<br><b>E36</b> · 36" End Fed<br><b>BXX</b> · Custom Back Fed<br><b>EXX</b> · Custom End Fed  |  |
|   |  |  | <b>XX</b> · Custom (XX.XX)<br><i>Continuous runs will be made in equal sections no more than 8' long</i><br><b>NOTE:</b> For Channels and Lenses over 90", incremental shipping charges will apply  |  |

\*1 Refer to page 2 for LED cut length intervals and available CCT

\*2 DMX driver required

\*3 Anodized finish

## LED Technical Information

|               | STYLE       | WATT/FT | DELIVERED LM/FT<br>CLEAR | DELIVERED LM/FT<br>FROSTED | CRI   | MAX. LENGTH | Color TEMPERATURE                           |                        |
|---------------|-------------|---------|--------------------------|----------------------------|-------|-------------|---|------------------------|
| Static White  | LLHE48LO-1W | 1.0     | 103                      | 65                         | 92    | 60'         | 2200K, 2500K, 2700K,<br>3000K, 3500K, 4000K |                        |
|               | LLHE48LO    | 1.9     | 207                      | 131                        | 92    | 48'         |   |                        |
|               | LLHE48SO    | 2.8     | 296                      | 187                        | 92    | 42'         |   |                        |
|               | LLHE48MO    | 3.5     | 395                      | 249                        | 92    | 33'         |   |                        |
|               | LLHE48HO    | 6.5     | 634                      | 400                        | 92    | 21'         |   |                        |
|               | 271         | 7.3     | 720                      | 454                        | 80/90 | 9.8'        |   | 80 CRI<br>2200K, 2500K |
|               | 382         | 10.2    | 977                      | 616                        | 80/90 | 6.55'       |   |                        |
| Dynamic Color | CT1         | 10.67   | ---                      | ---                        | 85    | 14.75'      | 2000K - 5700K                               |                        |
|               | RGB         | 4.4     | ---                      | ---                        | ---   | 16.4'       | Red/Green/Blue                              |                        |
|               | RGB+W       | 5.85    | ---                      | ---                        | 90    | 13.1'       | Red/Green/Blue<br>White LED 90 CRI / 3000K  |                        |
|               |             |         |                          |                            |       |             |   |                        |

\* Lumen output calculations based on 3500K. For LED strip information, See the LLHE48 spec sheet [HERE](#).

## Lens/Light Distribution

part number **500** (frosted 65% transparent)  
**502** (clear 95% transparent)

- PMMA construction
- Easily clipped in profile
- Comes precut to match profile length
- Flush

Clear Lens

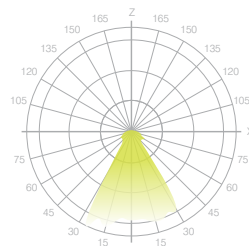

Frosted Lens

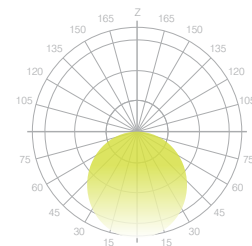

## Construction

- Housing: Aluminum extrusion
- Made in Canada

## Installation

- Factory assembled for easy and fast installation
- Electrical wire included

## Dimensions

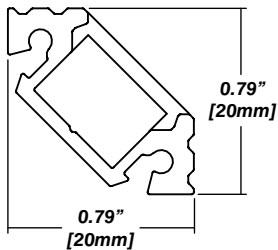

## 45° Mount Clip

part number **555-315-20**

- Steel construction
- Profile is mounted flush to surface
- Not visible once installed

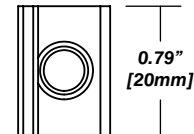
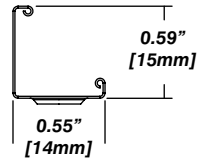

## Joining Sections

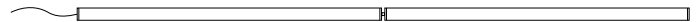

## Universal Power Supply 1% 120VAC - 277VAC

### Universal Power Supply 1% 120VAC - 277VAC

| MODEL                    | POWER  | OUTPUT      |
|--------------------------|--|-------------|
| PDCU-D - IP20 Dry Series | 30 - 30 W<br>60 - 60 W<br>96 - 96 W<br>3X96 - 3X96 W | 24 - 24 VDC |
| PDCU-W - IP66 Wet Series | 96 - 96 W<br>3X96 - 3X96 W                           |             |

0-10V dims down to 1%, MLV/ELV/TRIAC dims down to 1%.  
 Contact Senso to specify 347V transformer.  
 For a complete details on the Universal Power Supply, see Spec Sheet, Compatible Dimming and Install Guide on the [Resources page](#).

| MODELS | PDCU-W 96W | PDCU-W 3X96W | PDCU-D 30W | PDCU-D 60W | PDCU-D 96W | PDCU-D 3X96W |
|--------|------------|--------------|------------|------------|------------|--------------|
| Length | 8.66"      | 11.85"       | 6.10"      | 7.93"      | 8.25"      | 9.57"        |
| Width  | 3.73"      | 4.32"        | 3.35"      | 3.35"      | 4.10"      | 5.94"        |
| Depth  | 1.61"      | 1.81"        | 1.33"      | 1.32"      | 1.56"      | 1.13"        |

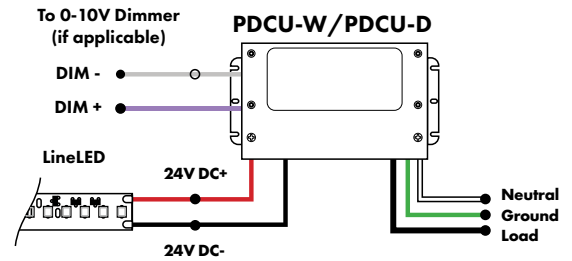

**30W/60W 347V Transformer**  
 attaches directly to PDCU box

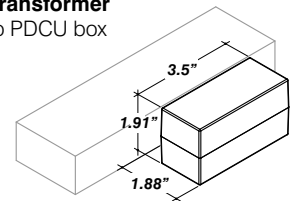

**96W 347V Transformer**  
 wired to PDCU box

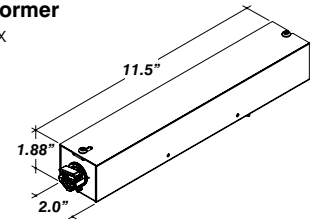

## DMX Dimming Power Supply 120VAC - 277VAC

### DMX Dimming Power Supplies 120VAC - 277VAC

| MODEL                                    | POWER                              | OUTPUT      |
|--|------------------------------------|-------------|
| PSDMX - DMX Power Supply dims down to 0% | 96 - 96 Watt<br>3X96 - 3 X 96 Watt | 24 - 24 VDC |

Features eldoLED's LINEARdrive configurable dimmable drivers. For a complete details on the DMX Dimming Power Supply, see Spec Sheet on the [Resources page](#).

| MODELS | 96W    | 3X96   |
|--------|--------|--------|
| Length | 14.40" | 15.75" |
| Width  | 5.20"  | 6.62"  |
| Depth  | 2.60"  | 4.95"  |

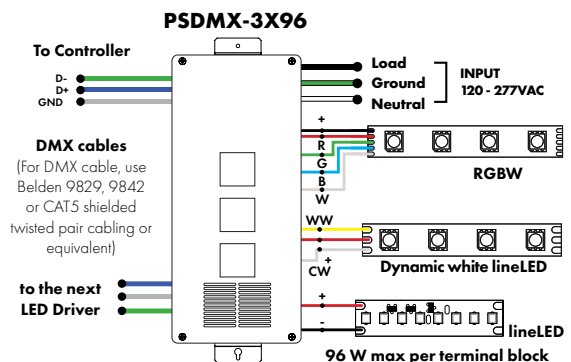
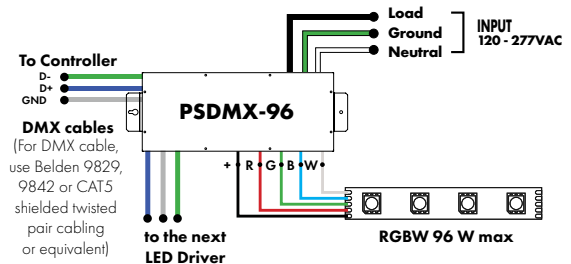



Luminii is a Lutron OEM Advantage Partner  
Lutron Power Supplies 1%

MODEL

**LTEA4U1UKL - CV240**

Lutron - Hi-lume™ 1% 2-wire LED Driver  
40W max

(120V forward phase only)

MODEL

**L3DA4U1UKL - CV240**

Hi-lume™ 1% EcoSystem Voltage LED driver  
40W max

| MODELS | LTEA4U1UKL-CV240 | L3DA4U1UKL-CV240 |
|--------|------------------|------------------|
| Length | 4.89"            | 4.98"            |
| Width  | 4.00"            | 4.00"            |
| Depth  | 2.62"            | 2.62"            |

For a complete details on the Lutron Power Supply, see Spec Sheet and Install Guide on the [Resources page](#).



Luminii is a Lutron OEM Advantage Partner  
Lutron Power Supplies 0.1%

MODEL

**L3D0-96W24V-U**

Hi-lume™ 0.1% EcoSystem Voltage LED Driver with Soft-On, Fade-to-Black™  
96W max

| MODELS | L3D0   |
|--------|--------|
| Length | 10.50" |
| Width  | 5.50"  |
| Depth  | 2.00"  |

