

DMX Power Supply 3 x 96 watt - Installation Instructions

Models PSDMX-3X96-24

Please read all instructions prior to installation and keep for future reference!



T 224.333.6033
www.opticarts.com

This class 2 power supply is to be installed by a qualified electrician in accordance with the National Electrical Code (NEC) and local building codes. The power supply must be installed in a well ventilated area and free from explosive gases and vapors. Proper operation requires the free flow of air. Power supply is well suited for LED or resistive loads at or below their maximum output rating per circuit. Suitable For Damp Location.

WARNING! Risk of Fire or Electric Shock, Do Not Interconnect Output Terminal.

Page 1 of 3

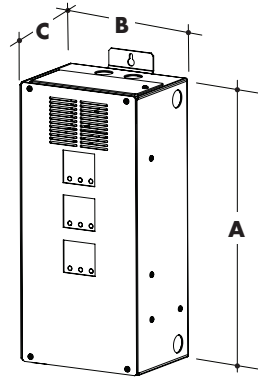

Models	PSDMX-3X96-24
A Height	14.00" (15.75" with mounting brackets)
B Width	6.62"
C Depth	4.95"
Input	120-277V AC, 3.3A, 50/60Hz
Output	24 VDC, 3 x 4.0 A, DMX512
Maximum wattage	3 x 96 W

1 Before installing, check the label and ensure the power supply has the proper input voltage, output voltage, and wattage for the job. Check the wire markings to ensure they match the wiring diagram below. Refer to table above for the maximum loads supported by each power supply.

It is recommended that the power supply be mounted vertically & mount a minimum of 12" above ground level or deck, 24" below ceiling, and allow 4" of clearance around power supply (excluding the mounting side) to provide for proper air circulation. Use the provided hardware to mount properly to wall.

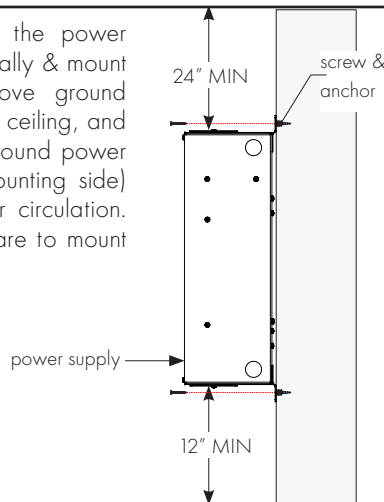

2 Remove the wiring compartment cover and knockouts on both ends of the power supply to connect.

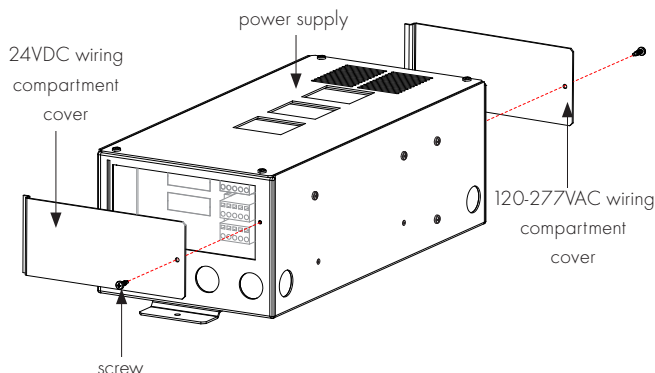

3 Connect the white (neutral) & black (hot) power supply wires to the white & black power wires (120-277VAC). Followed by connecting the ground wires in accordance with local electrical codes.

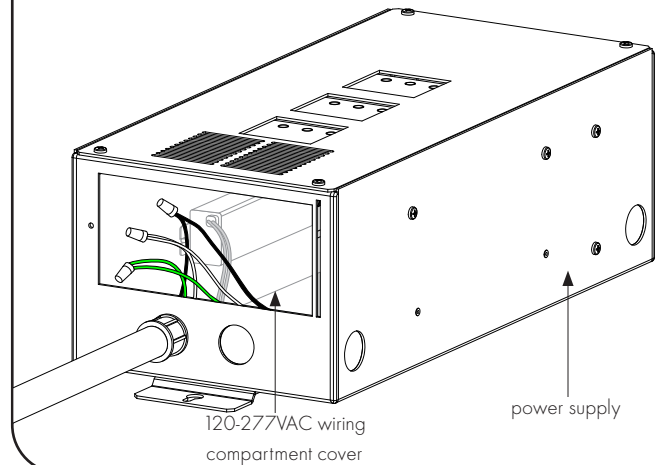

4 Reference wiring diagrams on page 2. Feed wire into the terminal block hole. By inserting a small flat screw driver into the terminal block slot and push down. Which will open the terminal block hole. Then insert the wire lead and release the screw driver to secure wire in place.

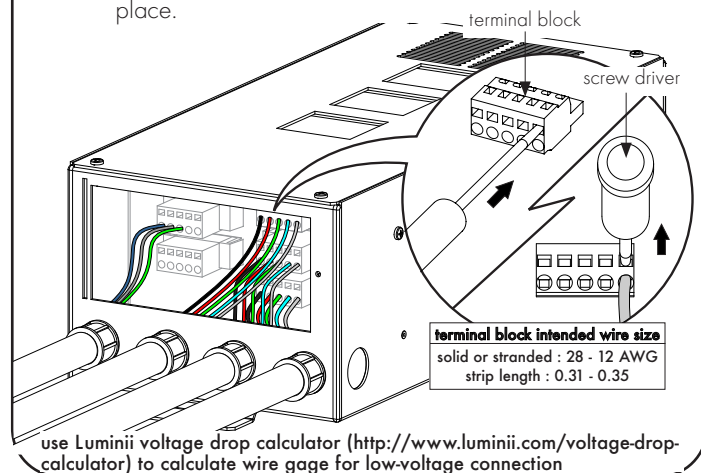

DMX Power Supply 3 x 96 watt - Installation Instructions

Models PSDMX-3X96-24

Please read all instructions prior to installation and keep for future reference!

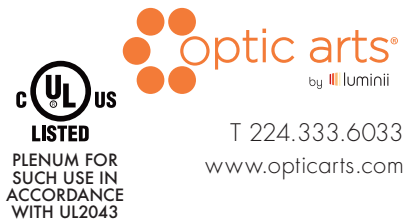

This class 2 power supply is to be installed by a qualified electrician in accordance with the National Electrical Code (NEC) and local building codes. The power supply must be installed in a well ventilated area and free from explosive gases and vapors. Proper operation requires the free flow of air. Power supply is well suited for LED or resistive loads at or below their maximum output rating per circuit. Suitable For Damp Location.

WARNING! Risk of Fire or Electric Shock, Do Not Interconnect Output Terminal.

Page 2 of 3

Wiring Diagrams

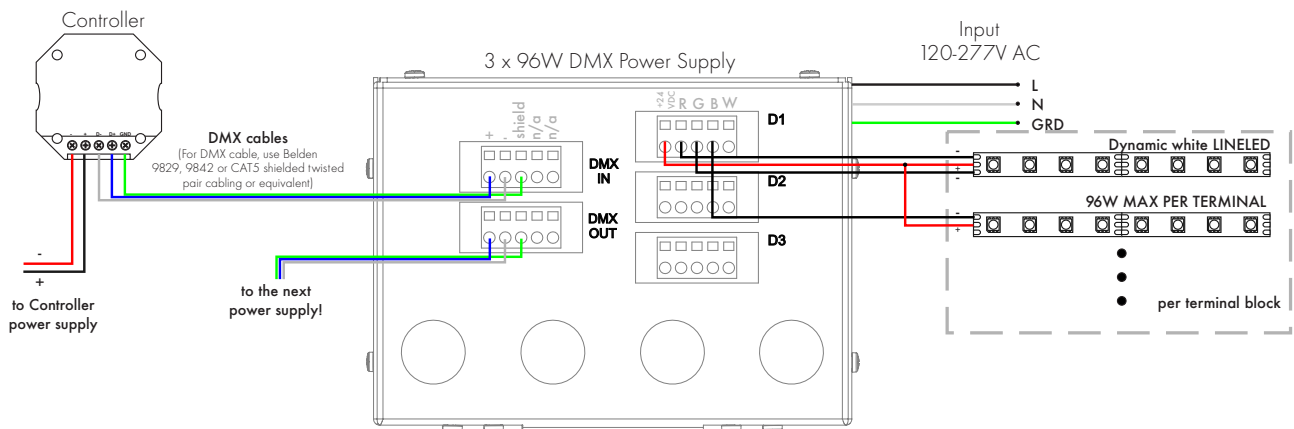
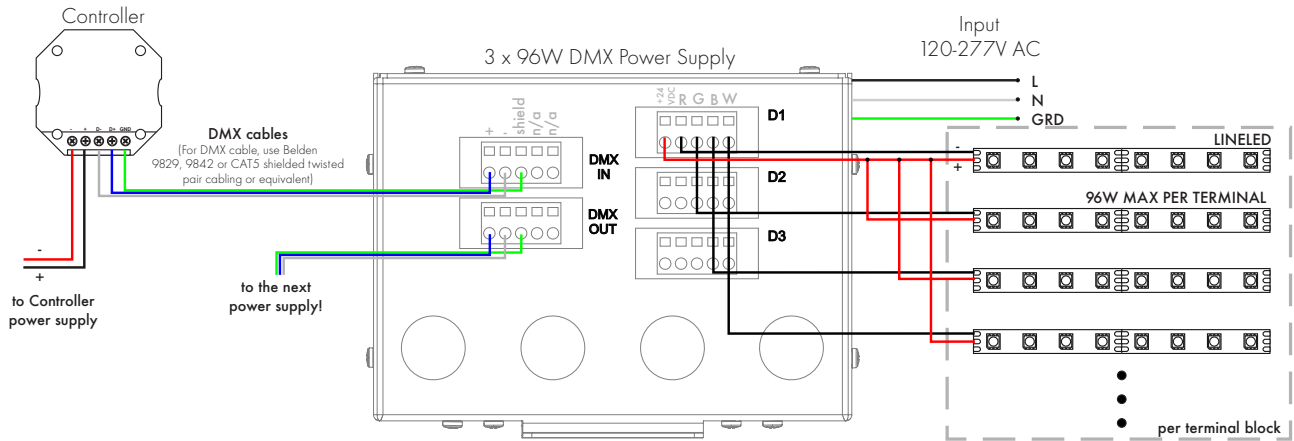
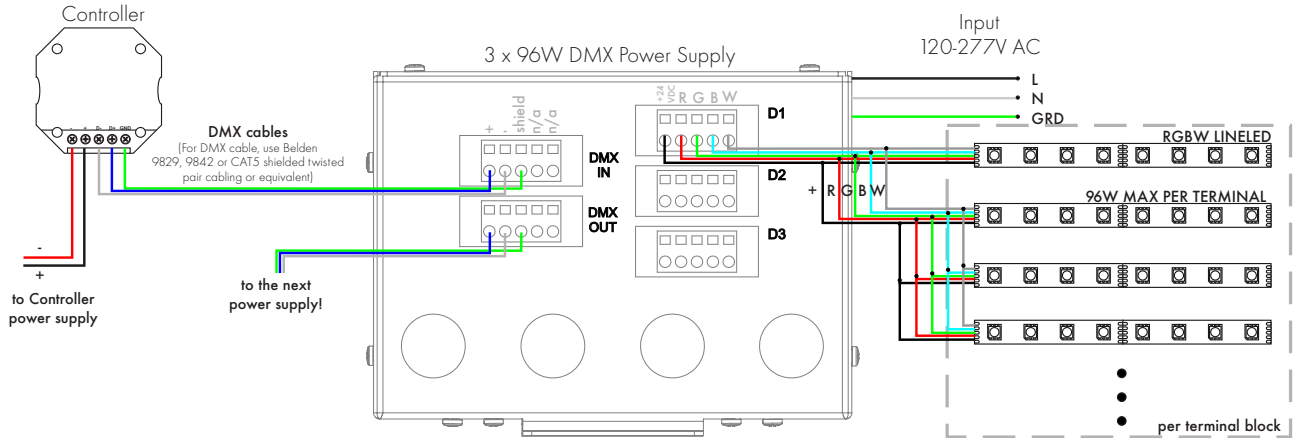

DMX Power Supply 3 x 96 watt - Installation Instructions

Models PSDMX-3X96-24

Please read all instructions prior to installation and keep for future reference!

This class 2 power supply is to be installed by a qualified electrician in accordance with the National Electrical Code (NEC) and local building codes. The power supply must be installed in a well ventilated area and free from explosive gases and vapors. Proper operation requires the free flow of air. Power supply is well suited for LED or resistive loads at or below their maximum output rating per circuit. Suitable For Damp Location.

WARNING! Risk of Fire or Electric Shock, Do Not Interconnect Output Terminal.

Programming Decoders

Manual configuration

1. Select mode of operation:

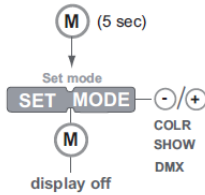

2. Set LED groups:

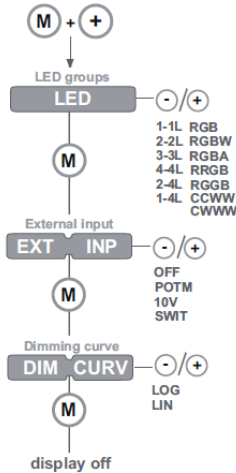

3. Standalone operation - Colour*-

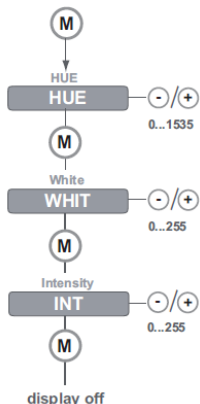

Standalone operation - Show -

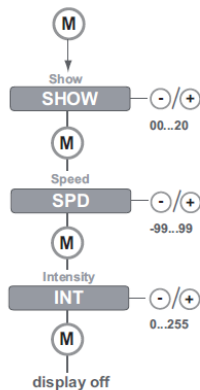

Networked operation - DMX -

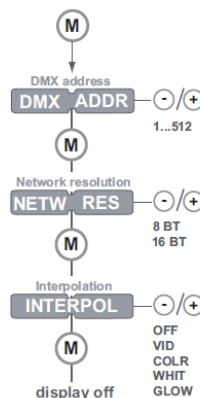

* The colour menu depends on the LED group settings you have selected in step 2.

Other features

Visual test run

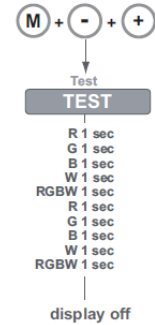

Locking the configuration:

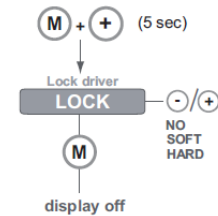

Reset to factory defaults

