

DMX Power Supply 3 x 96 watt - Installation Instructions

Models PSDMX-3X96-24

Please read all instructions prior to installation and keep for future reference!

This class 2 power supply is to be installed by a qualified electrician in accordance with the National Electrical Code (NEC) and local building codes. The power supply must be installed in a well ventilated area and free from explosive gases and vapors. Proper operation requires the free flow of air. Power supply is well suited for LED or resistive loads at or below their maximum output rating per circuit. Suitable For Damp Location.

WARNING! Risk of Fire or Electric Shock, Do Not Interconnect Output Terminal.



7777 Merrimac Ave
Niles, IL 60714
T 224.333.6033
F 224.757.7557
info@luminii.com
www.luminii.com

PLENUM FOR SUCH USE IN ACCORDANCE WITH UL2043

REV1.3
05192023

1 / 3

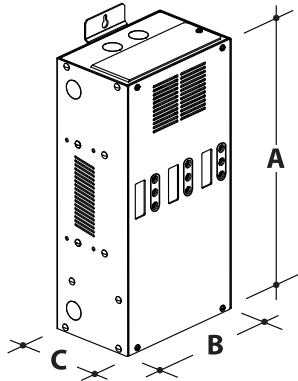

Models PSDMX-3X96-24

A. Height	13.00"
B. Width	6.60"
C. Depth	4.20"
MAX Load	3 x 96 Watts

3

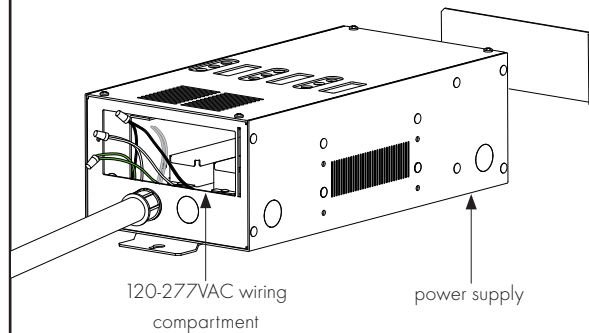

Connect the white (neutral) and black (hot) power supply wires to the white and black power wires (120 - 277 VAC). Followed by connecting the ground wires in accordance with local electrical codes.

1

It is recommended that the power supply be mounted vertically & mount a minimum of 12" above ground level or deck, 24" below ceiling, and allow 4" of clearance around power supply (excluding the mounting side) to provide for proper air circulation. Use the provided hardware to mount properly to wall.

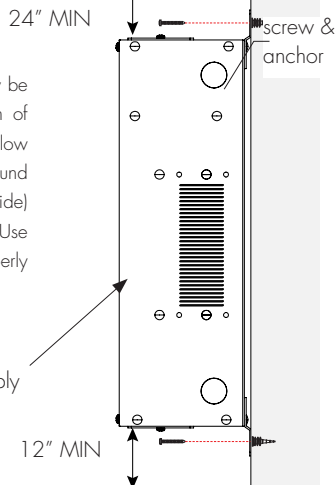

Before installing, check the label and ensure the power supply has the proper input voltage, output voltage, and wattage for the job. Check the wire markings to ensure they match the wiring diagram below. Refer to table above for the maximum loads supported by each power supply.

4

Reference wiring diagrams on page 2. Feed wire into the terminal block hole by inserting a small flat-head screwdriver into the terminal block slot and push down, thus opening the terminal block hole. Then, insert the wire lead and release the screwdriver to secure wire in place.

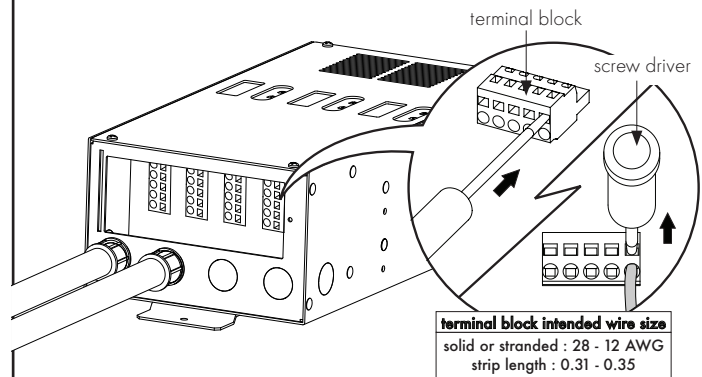

use Luminii voltage drop calculator (<http://www.luminii.com/voltage-drop-calculator>) to calculate wire gage for low-voltage connection

2

Remove the wiring compartment cover and knockouts on both ends of the power supply to connect.

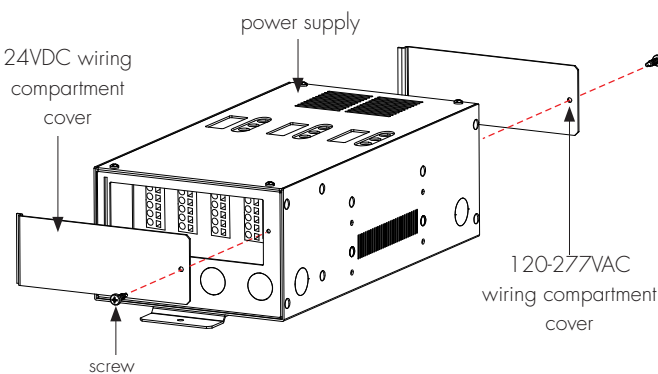

5

Secure compartment cover back onto the power supply.

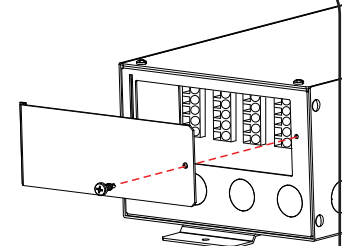

DMX Power Supply 3 x 96 watt - Installation Instructions

Models PSDMX-3X96-24



7777 Merrimac Ave
Niles, IL 60714
T 224.333.6033
F 224.757.7557
info@luminii.com
www.luminii.com

Please read all instructions prior to installation and keep for future reference!

This class 2 power supply is to be installed by a qualified electrician in accordance with the National Electrical Code (NEC) and local building codes. The power supply must be installed in a well ventilated area and free from explosive gases and vapors. Proper operation requires the free flow of air. Power supply is well suited for LED or resistive loads at or below their maximum output rating per circuit. Suitable For Damp Location.

PLENUM FOR SUCH USE IN ACCORDANCE WITH UL2043

REV1.3
05192023

2 / 3

WARNING! Risk of Fire or Electric Shock, Do Not Interconnect Output Terminal.

WIRING DIAGRAM

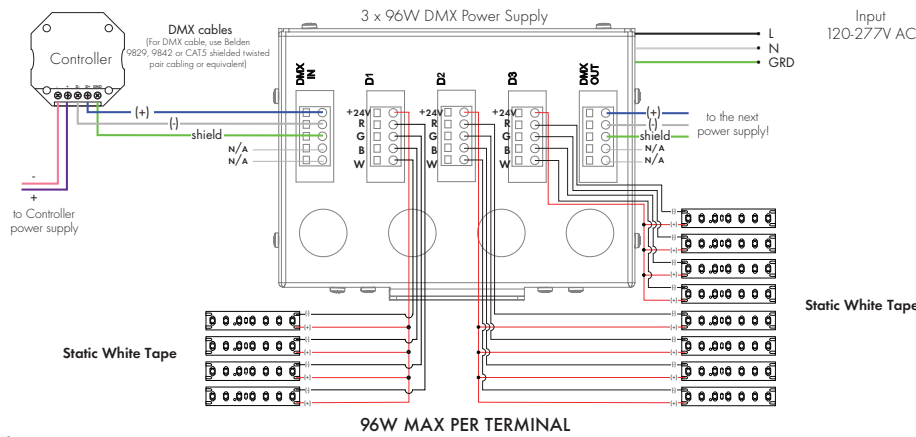
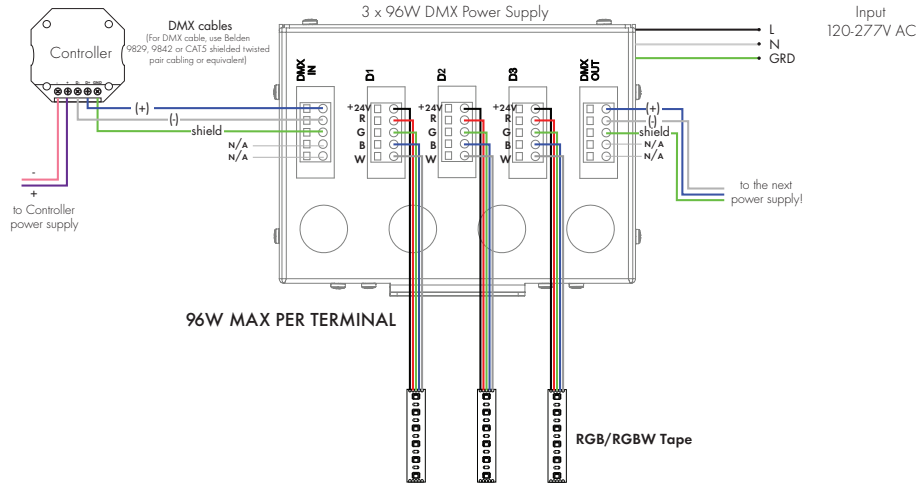

Configuration of the LED groups:
Press M and + simultaneously, in the LED menu choose 1-4L and save this setting by pressing M.

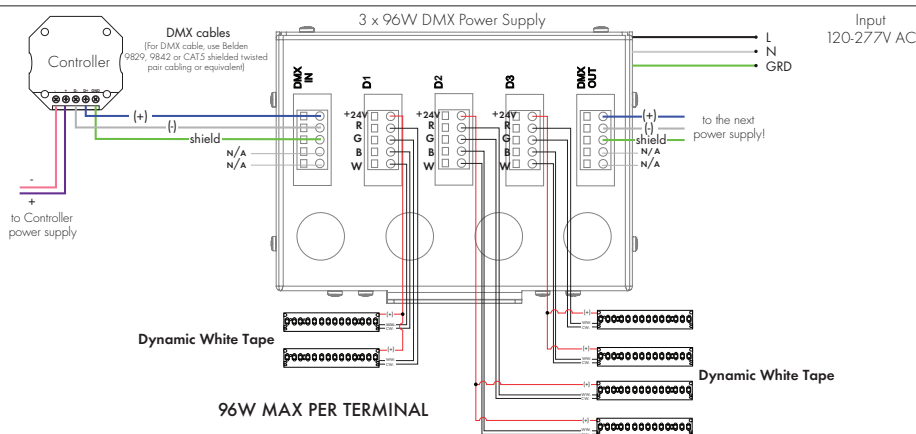

DMX Power Supply 3 x 96 watt - Installation Instructions

Models PSDMX-3X96-24



7777 Merrimac Ave
Niles, IL 60714
T 224.333.6033
F 224.757.7557
info@luminii.com
www.luminii.com

Please read all instructions prior to installation and keep for future reference!

This class 2 power supply is to be installed by a qualified electrician in accordance with the National Electrical Code (NEC) and local building codes. The power supply must be installed in a well ventilated area and free from explosive gases and vapors. Proper operation requires the free flow of air. Power supply is well suited for LED or resistive loads at or below their maximum output rating per circuit. Suitable For Damp Location.

PLENUM FOR SUCH USE IN ACCORDANCE WITH UL2043

REV1.3
05192023

3 / 3

WARNING! Risk of Fire or Electric Shock, Do Not Interconnect Output Terminal.

Manual configuration

1. Select mode of operation:

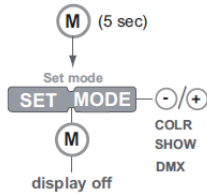

2. Set LED groups:

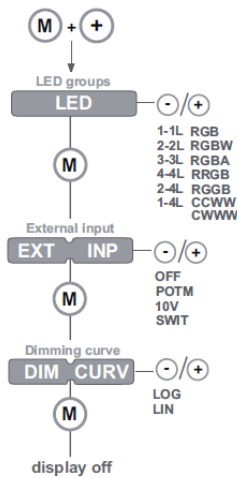

3. Standalone operation - Colour*-



Standalone operation - Show -

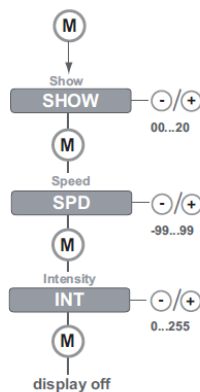

Networked operation - DMX -

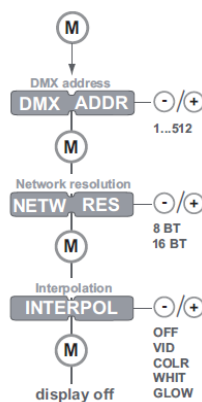

* The colour menu depends on the LED group settings you have selected in step 2.

Other features

Visual test run

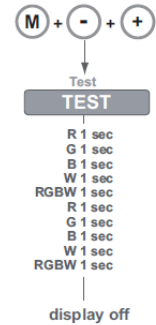

Locking the configuration:

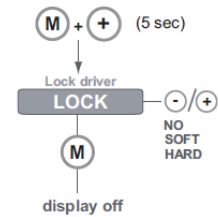

Reset to factory defaults

