

DAGGER

SURFACE MOUNT



Dagger - Linear LED system. Wherever a technically straightforward, economic linear lighting is needed, DAGGER is the ideal solution. The flexible LED modules are available in per-assembled configurations in defined lengths and can be built to any special length for the clients requirements. This not only offers tremendous advantages for installation but also ensures the look you designed the linear lighting into the space.

Ordering Code

Fixture	565	135						
	1	2	3	4	5	6	7	8
Driver		24						
	1	2	3	4	5			

Product Specifications

SAMPLE : Fixture **565 - 135 - 500 - 030 - 27 - 02 - E36 - 6'** | Driver **902 - 24 - 025 - STD - 120**

1 - Type	2 - Model	3 - Lens	4 - LED Style ^{*1/3}				
565 · Profile	135 · Dagger	500 · Frosted 502 · Clear 512 · Black	Eco 030 · 110 060 · 207 095 · 329 120 · 433	Pro 56 062 · 194 117 · 376 167 · 540 219 · 706	Pro 112 122 · 383 175 · 559 221 · 742 271 · 910 382 · 1235	Controlled White ^{*2} CT1 · 1059	RGB ^{*2} RGB · RGB RGBW · RGB+W
5 - CCT				6 - Finish	7 - Feed Point	8 - Fixture Length ^{*3}	
Eco 27 · 2700K 32 · 3200K 41 · 4100K	Pro 80 CRI 22 · 2200K 25 · 2500K	Pro 90 CRI 27 · 2700K 30 · 3000K 35 · 3500K 40 · 4000K 50 · 5000K	Controlled White ^{*2} CT1 · 2000 - 5700K 98 · RGB 99 · RGB+W	01 · White 02 · Black 08 · Silver XX · Custom	B36 · 36" Back Fed E36 · 36" End Fed BXX · Custom Back Fed EXX · Custom End Fed	XX · Custom (XX.XX) <i>Continuous runs will be made in equal sections no more than 8' long</i>	
1 - Driver	2 - Output Voltage	3 - Wattage	4 - Control		Dim Level	5 - Input Voltage	
902 · Standard Driver 908 · Magnetic Low-Voltage	24 · 24V	025 · 25W ^{*4} 040 · 40W 060 · 60W 096 · 96W	STD · Standard Driver DIM · Magnetic Driver ^{*5} LCS · 0 - 10 Volt Protocol DALI · Dali Protocol ^{*6} DMX · SENSO LUTRON · Lutron CV ^{*6}		N/A 1% 1% 0.1% 1% 0.1%	120 · 120V 277 · 277V 347 · 347V ^{*7}	

*1 Measured in Lm/ft

*2 DMX driver required

*3 Refer to page 2 for LED cut length intervals

*4 Not available with 908 Driver

*5 Only available with 908 driver and 120V

*6 Only available in 96W

*7 Not available in DALI, LUTRON or DMX

24V Linear LED Light Source

	STYLE	WATT/FT	LUMENS/FT	CRI	MAX. LENGTH	CUT LENGTH	LED/FT	Color TEMPERATURE	DESCRIPTION
ECO	030	1.46	110	83	16.4'	3.94"	18	2700K, 3200K, 4100K	Versatile strip with 3 LED densities, 3 color temperatures and a CRI of 83
	060	2.93	207	83	16.4'	1.97"	36		
	095	4.39	329	83	16.4'	3.94"	18		
	120	5.85	433	83	16.4'	0.98"	73		
PRO 56	062	1.5	194	80/90	32.8'	4.92"	17	80 CRI 2200K, 2500K	Even LED layout (56 led/m - 17 led/ft) for balanced performance and efficiency
	117	2.9	376	80/90	16.4'	4.92"	17		
	167	4.4	540	80/90	13.1'	4.92"	17		
	219	5.9	706	80/90	9.84'	4.92"	17		
PRO 112	122	2.9	383	80/90	23.0'	2.46"	34	90 CRI 2700K, 3000K, 3500K, 4000K, 5000K	Dense LED layout (112 led/m - 34 led/ft) creates no dots with frosted lens
	175	4.4	559	80/90	14.75'	2.46"	34		
	221	5.9	742	80/90	11.5'	2.46"	34		
	271	7.3	910	80/90	9.8'	2.46"	34		
Controlled White	CT1	10.67	1059	85	14.75'	3.54"	40	2000K - 5700K	Color Tunable led strip with a warm/cool range from 2000K to 5700K
RGB	RGB	4.39	204	-	16.4'	3.94"	18	-	Individually control Red, Green, Blue and White (white only with RGB+W)
	RGB+W	6.78	364	-	10.7'	3.54"	81		

* Lumen output based on 3000K / 90CRI. For other output information, please consult SENSO.

Key LED Strip Features

- 3 STEP MacAdam LEDs or Single Bin LEDs
- Stabilized current design
- LED strip efficacy up to 171 lm/W
- Only 8 mm width
- 24V DC voltage input
- Reverse voltage protection
- Thermal conductive adhesive on back side for better heat conduction
- 50,000 hour life expectancy

Lens/Light Distribution

part number **500** (frosted 65% transparent)
502 (clear 95% transparent)

- PMMA construction
- Easily clipped in profile
- Comes precut to match profile length
- Flush

Clear Lens

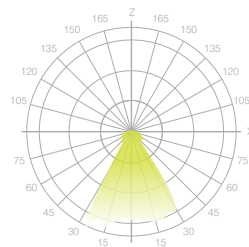

Frosted Lens

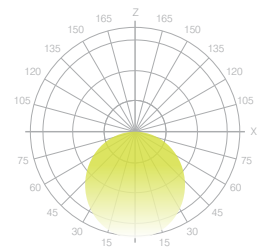

DAGGER

SURFACE MOUNT

Construction

- Housing: Aluminum extrusion
- Made in Canada

Installation

- Factory assembled for easy and fast installation
- Electrical wire included

Dimensions

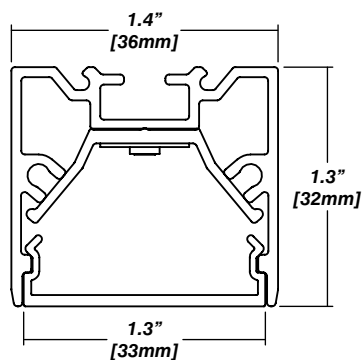

Joining Sections

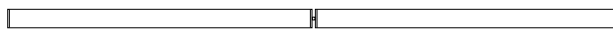

Mounting

- Removal of lens, reflector and LED for surface-mount installation

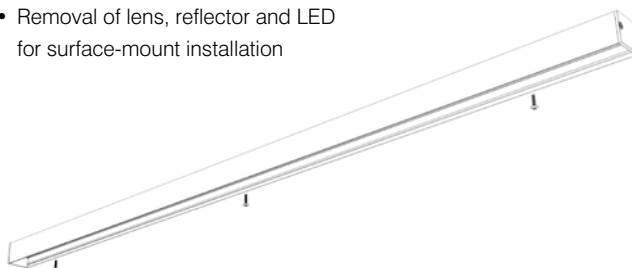

Drivers for Linear Aluminum Profile

Driver Data

Driver	Output Voltage	Input voltage	Wattage	Efficiency @ Max Load	Power Factor	Dim Level	Dim Protocol	
STD	24V	120V, 277V, 347V	25W - 96W	86%	>0.90	N/A	N/A	
DIM		120V	40W - 96W	>90%	>0.95	1%	Magnetic	
LCS		120V, 277V, 347V	60W - 96W	>87%	>0.95	10%	0-10V	
DALI		120V, 277V	96W			>0.94	0.1%	DALI
DMX		120V, 277V	25W - 96W				1%	DMX
LUTRON		120V, 277V	96W	90%	>0.99	0.1%	ECO System	

Features

- CSA Approved
- Class 2, Class P
- Auto-reset protection for short circuit and over-temperature
- Overload protection

STD / DMX

DMX requires decoder

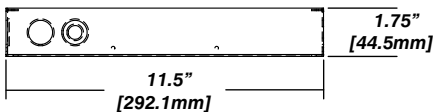
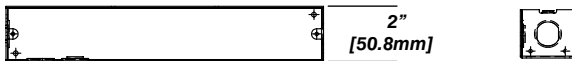

LCS

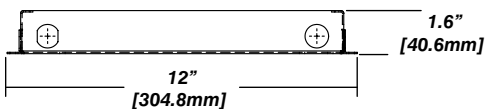
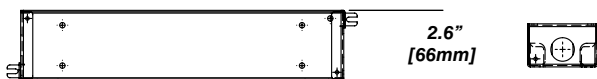

347V

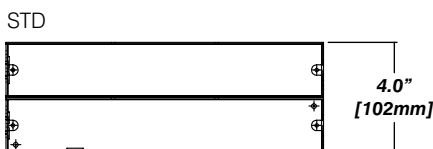

DALI

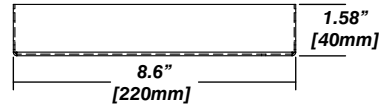
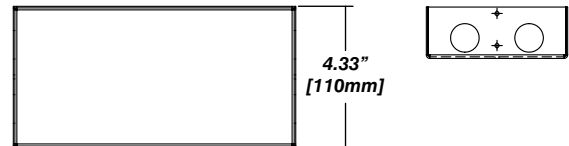

LUTRON

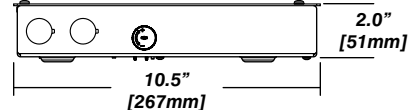
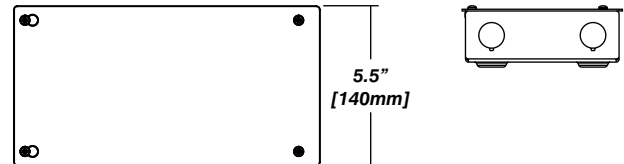

DIM

