

CUTLASS

SUSPENDED



Cutlass - Linear LED System. The Cutlass is designed primarily for flush mount applications. With the many options available, it is highly modular versatile and easy to install.

Ordering Code

Fixture	555	916						
	1	2	3	4	5	6	7	8

Product Specifications

SAMPLE : Fixture **555 - 916 - 500 - LO - 27 - 02 - 5 - 6'**

1 - Type	2 - Model	3 - Lens	4 - LED Style*1	
555 · Profile	916 · Cutlass Suspended	500 · Frosted 502 · Clear	Static White LO1W · LLHE48LO-1W 1 Watt LO · LLHE48LO Low Output SO · LLHE48SO Standard Output MO · LLHE48MO Medium Output HO · LLHE48HO High Output 271 · 271 Style LED Strip 382 · 382 Style LED Strip	Dynamic Color*2 CT1 · Tunable White RGB · RGB Color changing RGBW · RGB+W Color changing
5 - CCT	6 - Finish	7 - Suspension Length	8 - Fixture Length*1	
Static White 22 · 2200K 25 · 2500K 27 · 2700K 30 · 3000K 35 · 3500K 40 · 4000K 50 · 5000K	Dynamic Color*2 CT · Tunable White 98 · RGB Color changing 99 · RGB+W Color changing	01 · White 02 · Black*3 08 · Silver*3 XX · Custom	5 · 5' 8 · 8' Contact SENS0 for custom length	XX · Custom (XX.XX) <i>Continuous runs will be made in equal sections no more than 8' long</i> NOTE: For Channels and Lenses over 90", incremental shipping charges will apply

*1 Refer to page 2 for LED cut length intervals and available CCT
*2 DMX driver required
*3 Anodized finish

Project : _____
Quantity : _____
Type : _____
Notes : _____



LED Technical Information

	STYLE	WATT/FT	DELIVERED LM/FT CLEAR	DELIVERED LM/FT FROSTED	CRI	MAX. LENGTH	Color TEMPERATURE	
Static White	LLHE48LO-1W	1.0	74	55	92	60'	2200K, 2500K, 2700K, 3000K, 3500K, 4000K	
	LLHE48LO	1.9	148	110	92	48'		
	LLHE48SO	2.8	212	157	92	42'		
	LLHE48MO	3.5	283	209	92	33'		
	LLHE48HO	6.5	454	336	92	21'		
	271	7.3	515	381	80/90	9.8'		80 CRI 2200K, 2500K 90 CRI 2700K, 3000K, 3500K, 4000K, 5000K
	382	10.2	681	504	80/90	6.55'		
Dynamic Color	CT1	10.67	---	---	85	14.75'	2000K - 5700K	
	RGB	4.4	---	---	---	16.4'	Red/Green/Blue	
	RGB+W	5.85	---	---	90	13.1'	Red/Green/Blue White LED 90 CRI / 3000K	

* Lumen output calculations based on 3500K. For LED strip information, See the LLHE48 spec sheet [HERE](#).

Lens/Light Distribution

part number **500** (frosted 65% transparent)
502 (clear 95% transparent)

- PMMA construction
- Easily clipped in profile
- Comes precut to match profile length
- Flush

Clear Lens

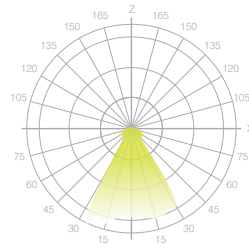

Frosted Lens

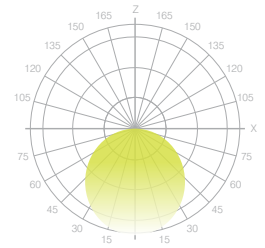

Construction

- Housing: Aluminum extrusion
- Made in Canada

Installation

- Factory assembled for easy and fast installation
- Electrical wire included

Dimensions

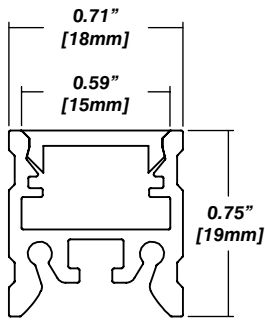

Joining Sections



Remote Driver Canopy

part number **921**

- Aluminum feed canopy
- Aircraft cable holder
- For remote driver mounting only
- W - Ø5" [125mm]
- H - 0.65" [16.7mm]



Lead Cable Strain Relief

- Used as a feeding point for lead cable
- Secured in place with set screw.



Aircraft Cable Mounting Base

- Used to suspend profiles
- secured in place with set screw.



Universal Power Supply 1% 120VAC - 277VAC

Universal Power Supply 1% 120VAC - 277VAC

MODEL	POWER	OUTPUT
PDCU-D - IP20 Dry Series	30 - 30 W 60 - 60 W 96 - 96 W 3X96 - 3X96 W	24 - 24 VDC
PDCU-W - IP66 Wet Series	96 - 96 W 3X96 - 3X96 W	

0-10V dims down to 1%, MLV/ELV/TRIAC dims down to 1%.
 Contact Senso to specify 347V transformer.
 For a complete details on the Universal Power Supply, see Spec Sheet, Compatible Dimming and Install Guide on the [Resources page](#).

MODELS	PDCU-W 96W	PDCU-W 3X96W	PDCU-D 30W	PDCU-D 60W	PDCU-D 96W	PDCU-D 3X96W
Length	8.66"	11.85"	6.10"	7.93"	8.25"	9.57"
Width	3.73"	4.32"	3.35"	3.35"	4.10"	5.94"
Depth	1.61"	1.81"	1.33"	1.32"	1.56"	1.13"

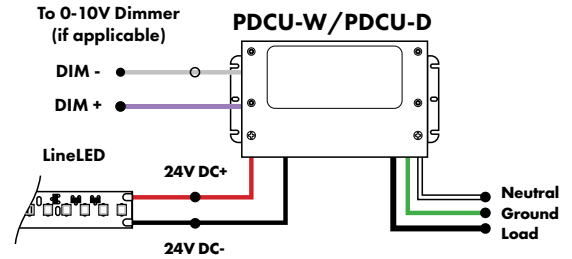

30W/60W 347V Transformer
 attaches directly to PDCU box

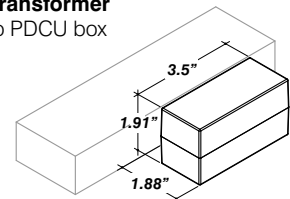

96W 347V Transformer
 wired to PDCU box

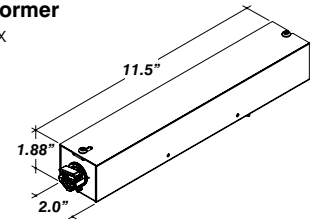

DMX Dimming Power Supply 120VAC - 277VAC

DMX Dimming Power Supplies 120VAC - 277VAC

MODEL	POWER	OUTPUT
PSDMX - DMX Power Supply dims down to 0%	96 - 96 Watt 3X96 - 3 X 96 Watt	24 - 24 VDC

Features eldoLED's LINEARdrive configurable dimmable drivers. For a complete details on the DMX Dimming Power Supply, see Spec Sheet on the [Resources page](#).

MODELS	96W	3X96
Length	14.40"	15.75"
Width	5.20"	6.62"
Depth	2.60"	4.95"

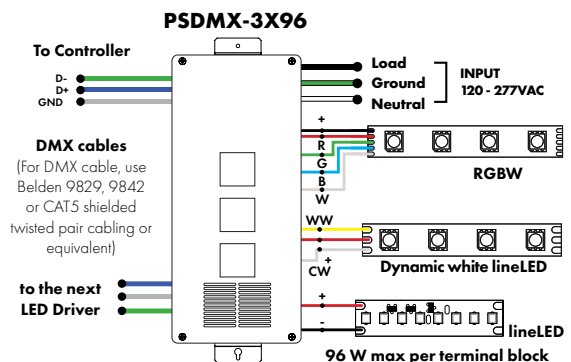
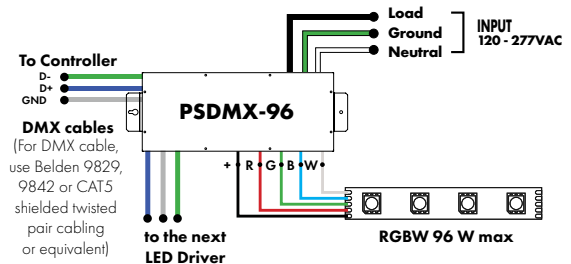

LUTRON®

Luminii is a Lutron OEM Advantage Partner
Lutron Power Supplies 1%

MODEL

LTEA4U1UKL-CV240

Lutron - Hi-lume™ 1% 2-wire LED Driver
40W max

(120V forward phase only)

MODEL

L3DA4U1UKL-CV240

Hi-lume™ 1% EcoSystem Voltage LED driver
40W max

MODELS	LTEA4U1UKL-CV240	L3DA4U1UKL-CV240
Length	4.89"	4.98"
Width	4.00"	4.00"
Depth	2.62"	2.62"

For a complete details on the Lutron Power Supply, see Spec Sheet and Install Guide on the [Resources page](#).

LUTRON®

Luminii is a Lutron OEM Advantage Partner
Lutron Power Supplies 0.1%

MODEL

L3D0-96W24V-U

Hi-lume™ 0.1% EcoSystem Voltage LED Driver with Soft-On, Fade-to-Black™
96W max

MODELS	L3D0
Length	10.50"
Width	5.50"
Depth	2.00"

