

The BOS Channel linear aluminum extrusion has been designed to fit many LED lighting needs. Multiple mounting and lens options allow for great flexibility and adaptability for any application. Extrusion and diffuser lenses are also field cuttable. Substantial aluminum mass in profile provides excellent heat sink for high power LEDs. Mounting brackets and endcaps are available in multiple finishes and sold separately.

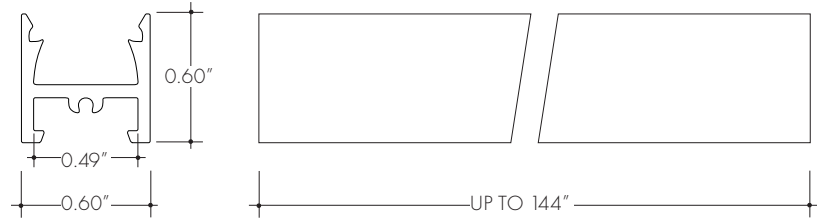
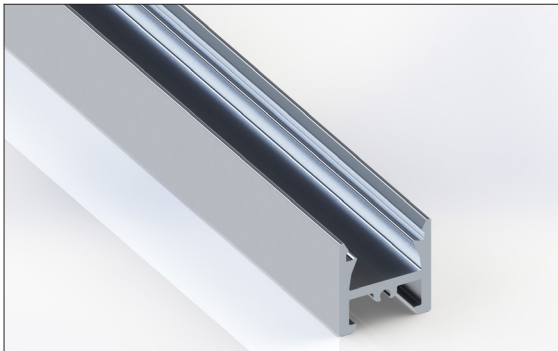

Technical information

Finish: Silver anodized, White

Diffuser lens: polycarbonate, snap-in-place, UV resistant

Mounting: multiple mounting brackets (page 2)

Lens Options	
Actual length	48", 72", 96", & 144"
Available lenses	- frosted - satin ice - graze - raised

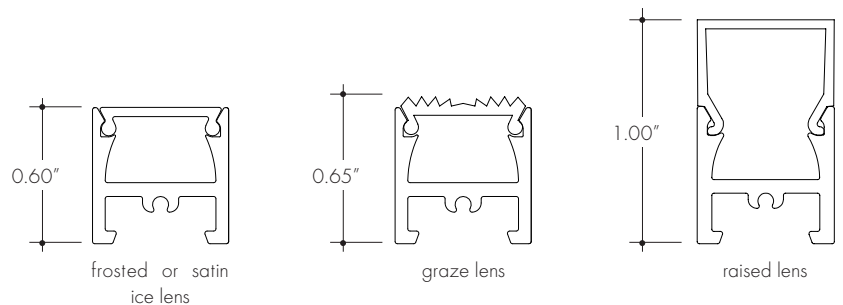

Ordering code

MODEL	LENGTH	LENS	FINISH
BOSC	48	F	SA
BOSC - BOS Channel	48 - 48" 72 - 72" 96 - 96" 144 - 144"	F - Frosted SI - Satin ice G - Graze R - Raised	SA - Silver anodized WH - White

All accessories sold separately.

Mounting brackets

- MC-BOSC-SNAP-48** 48" mounting channel
- MC-BOSC-SNAP-72** 72" mounting channel
- MC-BOSC-SNAP-96** 96" mounting channel
- MC-BOSC-SNAP-144** 144" mounting channel

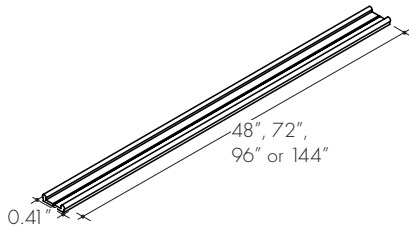

MB-BOSC-SA Silver anodized screw-in mounting bracket

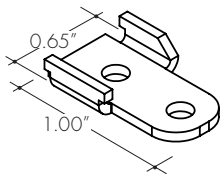

MB-BOSC-MAG magnet mounting bracket

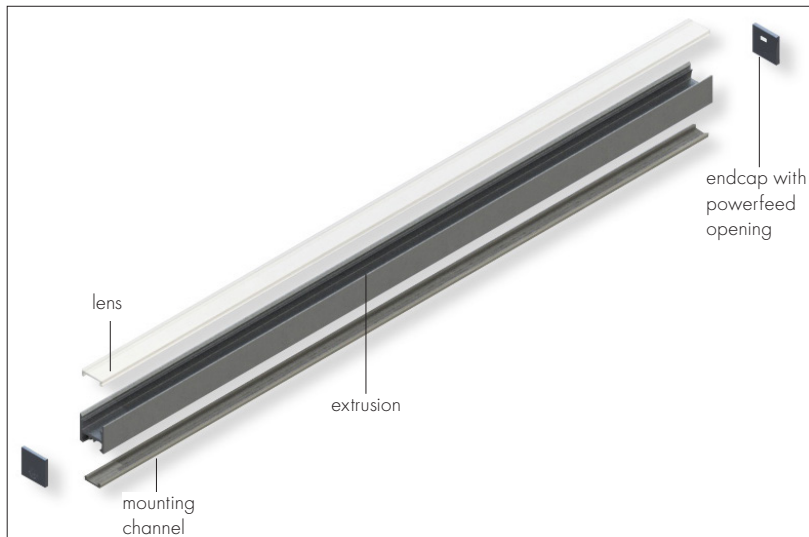
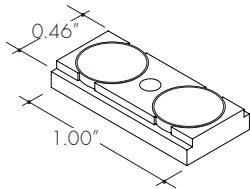

End-caps

- EC-BOS-F-H4-SA** Silver anodized w/powerfeed opening
- EC-BOS-F-H4-WH** White w/powerfeed opening

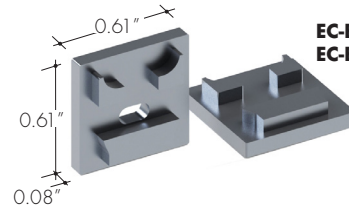

- EC-BOS-F-H3-SA** Silver anodized
- EC-BOS-F-H3-WH** White

- frosted & satin ice lens only

- EC-BOS-G-H4-SA** Silver anodized w/powerfeed opening
- EC-BOS-G-H4-WH** White w/powerfeed opening

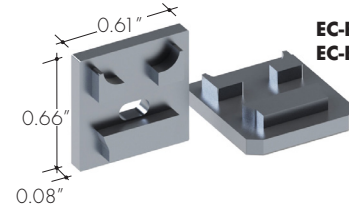

- EC-BOS-G-H3-SA** Silver anodized
- EC-BOS-G-H3-WH** White

- graze lens only

- EC-BOS-R-H4-SA** Silver anodized w/powerfeed opening
- EC-BOS-R-H4-WH** White w/powerfeed opening

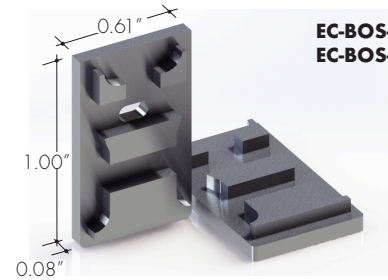

- EC-BOS-R-H3-SA** Silver anodized
- EC-BOS-R-H3-WH** White

- raised lens only