

ARTEMIS 2 A

RECESSED ADJUSTABLE LED DOWNLIGHT

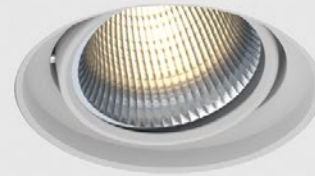

Artemis 2 A - Recessed Adjustable Downlight. Artemis 2 A features SENSO-designed reflectors and a wide range of color temperatures in a high performance yet efficient and compact package. As part of the Artemis family of downlights, it's easy to get a cohesive design regardless of fixture size or style.

Ordering Code

Fixture	AR2A								
	1	2	3	4	5	6	7	8	9
Driver		AR2A	--			--	--	--	
	1	2	3	4	5	6	7	8	

Product Specifications

SAMPLE: Fixture **AR2A - TL - A90 - 615 - 25 - 07 - DL - 02 - 08** | Driver **910 - AR2A - TL - STD - 120 - A90 - 07 - 08**

1 - Model	2 - Trim	3 - LED	4 - Optic	5 - CCT	6 - Lumen	7 - Accessory	8 - Trim Color
AR2A · Artemis 2 Adjustable	FL · Flanged TL · Trimless	A90 · 93+ CRI Accuracy	615 · 15° 630 · 30° 645 · 45° 660 · 60°	25 · 2500K 27 · 2700K 30 · 3000K 35 · 3500K 40 · 4000K 65 · 6500K	07 · 700 (7.4W) 10 · 1000 (10.6W) 15 · 1500 (16.6W) 20 · 2000 (25.2W)	00 · No Accessory DL · Diffusing Lens HO · Honeycomb	01 · White 02 · Black 08 · Silver XX · Custom

9 - Baffle Color	1 - Housing Style	2 - Model	3 - Trim	4 - Driver	Dim Level	Dim Level
01 · White 02 · Black 08 · Silver XX · Custom	910 · Remote* 915 · New Construction 920 · IC Housing* 930 · Chicago Plenum* ²	Same as Fixture	Same as Fixture	STD · Non Dimming LCS · 0 - 10 Volt Protocol DIM · Phase* ³ ELDOLC · EldoLED 0 - 10 Volt* ⁴ DALI · Dali Protocol* ⁴	N/A 1% 10% 0.1% 0.1%	LUTES · Hilume Ecodigital* ⁴ LUT2W · 2 Wire for phase* ^{3/4} DMX · SENSO* ⁴ EMG · Emergency Driver* ^{4/5} CSMB · Casambi Wireless Control* ^{4/5}

5 - Voltage	6 - LED	7 - Lumen	8 - Baffle Color* ⁶
120 · 120V 277 · 277V 347 · 347V	Same as Fixture	Same as Fixture	Same as Fixture

*1 Required for trimless
*2 Cannot exceed **1500lm**
*3 Not available in 277V
*4 Requires remote housing
*5 Specified separately
*6 Only needed for Trimless

Project : _____
Quantity : _____
Type : _____
Notes : _____

ARTEMIS 2 A

RECESSED ADJUSTABLE LED DOWNLIGHT



LED Module Performance

- Output:** up to 2000lm
- High Efficacy:** up to 96 lumen/Watt
- Color Options (CCT):** 2500K, 2700K, 3000K, 3500K, 4000K or 6500K
- Color Consistency:** Range within a 3-MacAdam Ellipse
- Color rendering (CRI):** 93+ CRI & 50+ R9 Value

Driver and Power Consumption

- Dimming:** 1% dimming standard with 0.1% option
- Ripple:** Industry leading Low ripple
- Efficiency:** Power Factor >0.9
Efficiency over 85%
Class 2 output for safety
- Installation:** Small Footprint allows retrofit installations

Lumen Option	700lm	1000lm	1500lm	2000lm
Fixture Wattage	7.4W	10.6W	16.6W	25.2W
Delivered Lumen	714lm	944lm	1465lm	2160lm

Accessories

Diffusing Lens



Honeycomb Mesh



Installation

- For new and retrofit installations
- Easy installation with spring loaded tabs
- Simple connection between fixture and driver via quick connect
- 0° to 30° adjustable tilt angle
- 360° rotation

Construction / Finish

- Satin powder coated finish
- Custom finishes are available
- Cast Aluminum Trim
- Made in Canada

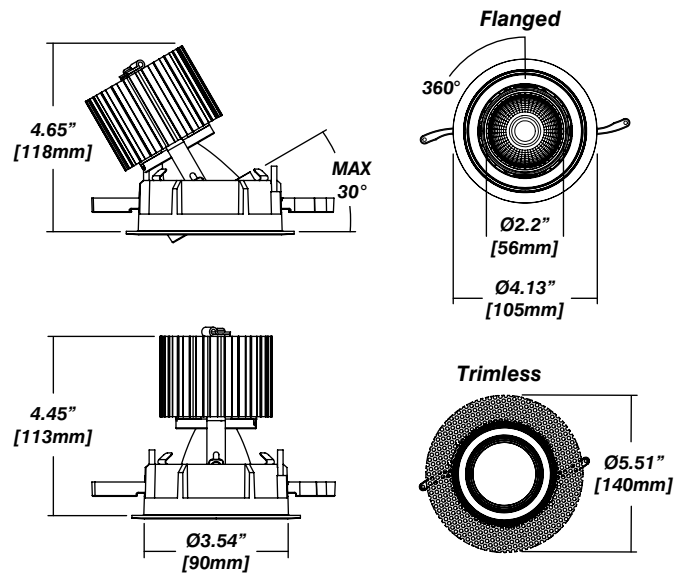
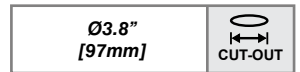

Reflector

Faceted Reflector

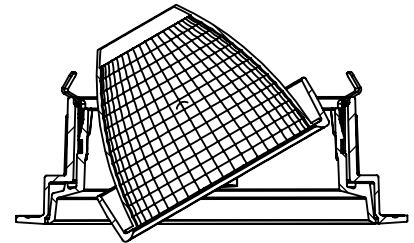

ARTEMIS 2 A

RECESSED ADJUSTABLE LED DOWNLIGHT

Housing Options

Standard Senso Housing - 910

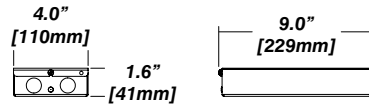
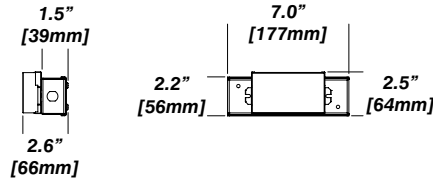
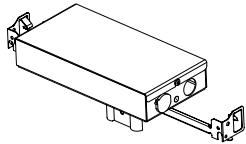
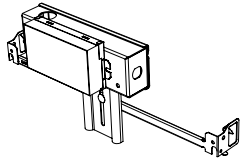

Dimension

Included

Unless specified otherwise, this is provided as standard

- Driver with enclosure**
- Galvanized steel enclosure
- Installation**
- Laying on top of ceiling
 - Remote from fixture
 - Hanger bar and mount included

New Construction - 915

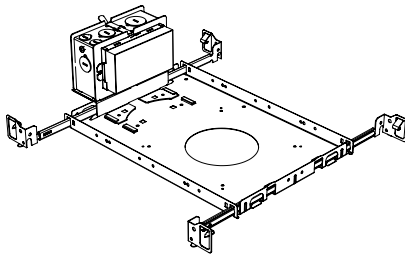

Dimension

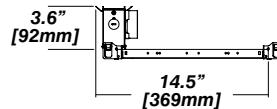
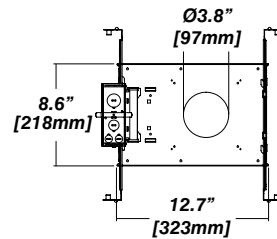

Included

- Plaster Frame**
- Galvanized steel construction with cut-out
- Bar hanger**
- Length: from 14-3/16" to 26"
- Outlet Box**
- Outlet Box Included (910 included with trimless)

IC Housing - 920 Chicago Plenum - 930

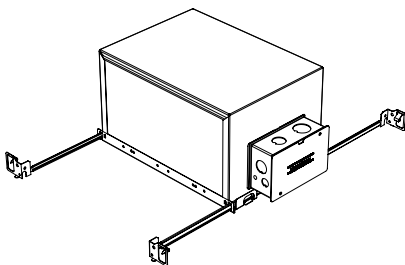

Dimension

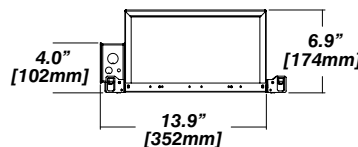
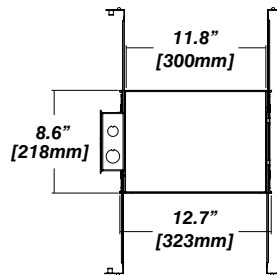

Included

- IC Housing**
- Galvanized steel construction
 - Airtight
 - Includes gasketed junction box
- Plaster Frame**
- Galvanized steel construction
- Bar hanger**
- Length: from 14-3/16" to 26"

Note: use only with LED modules up to 1500lm

