



Application: Wall Mount



An arm mounted fixture for wall washing, task lighting, and general illumination.

FEATURES

- Wall or ceiling mounting.
- Field rotatable up to 290° degrees.
- Static white and variable white options.

PART NUMBER BUILDER

SERIES	DIAMETER	FINISH	COLOR	AIMING	ARM LENGTH	CANOPY	TYPE	WATTAGE	LENGTH	DIMMING
ARM = Arm	125 = Ø1.25"	Standard Finish: SS = Satin Silver Anodized Powder Coat Finishes: BK = Matte Black - TIGER 061/8007 ¹ BZ = Bronze - TIGER 061/68002 ¹ WT = White - Cardinal T009-WH1114 Special Powder Coat Finishes: Grey - P008-GR16 ¹ Blue - T009-BL01 ¹ Red - T009-RD03 ¹ Yellow - T009-YL01 ¹ Chrome ¹ CR = Custom RAL # ____ ¹	18 = 1800K 23 = 2350K 27 = 2750K 29 = 2930K 35 = 3550K 1835 = Variable White 1800K + 3550K 1865 = Variable White 1800K + 6500K	CW1 = Ceiling/Wall, facing towards mounting surface CW2 = Ceiling/Wall, facing away from mounting surface	004 (ADA) = 4", max extension for ADA in wall configuration 006 = 6" 012 = 12" 024 = 24" CUS = Custom length, consult factory (24" max.)	LR = Large Round SR = Small Round LS = Large Square SS = Small Square	SI = Single COXX = Continuous Row Mount + Number of Sections ⁴ CE = Center Mount	20 = FLEX STP 2.0 40 = FLEX STP 4.0 70 = FLEX STP 7.0 58 = FLEX STP VW 5.8 ³	XX = Custom Length (Inches)	PDCL = Pure DC® Lite ND = Non-Dim 010 = 0-10V System Dimming VIN = VintageDim® System 0-10V Dimming ² PDC = Pure DC™ Dimming System DMX = DMX Dimming System LN2 = Lutron Hi-Lume® A-Series 2-Wire Dimming LN3 = Lutron Hi-Lume® A-Series 3-Wire/Ecosystem Dimming LNP = Lutron Hi-Lume® Premier 3-Wire/Ecosystem Dimming

Note: All White and Variable White Colors are JAB 2016 when used with 0-10V, DMX, Lutron A-Series (LN2), Lutron Premier (LN3) or VintageDim® (VIN) dimming.

1: Special order finishes. Additional charges and longer lead times may apply. 4: Cannot be used with Variable White.
 3: Must be selected for 1835 & 1865 color options

FUNCTIONALITY

AIMING OPTIONS (See PN Builder for details)

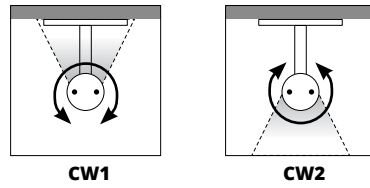

BLENDING/PHOTOMETRICS

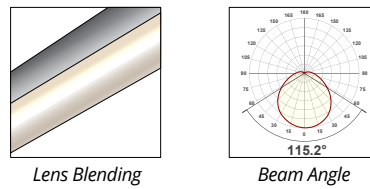

CANOPY OPTIONS

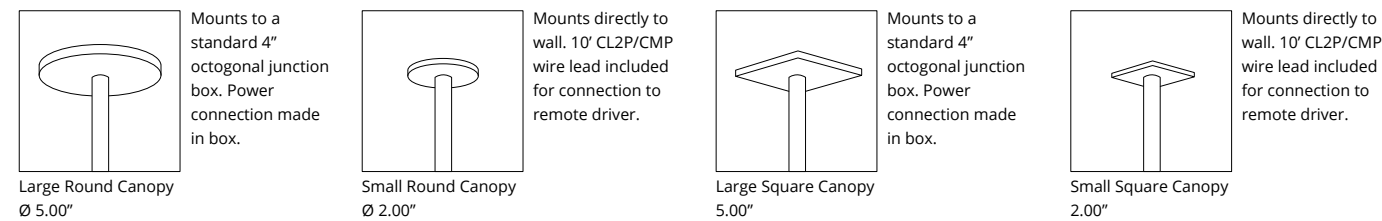

ELECTRICAL

Input Voltage	24VDC
Dimming Options	<ul style="list-style-type: none"> • PURE DC™ • MLV • 0-10V • VintageDim® • DMX • Lutron (2-WIRE, 3-WIRE, EcoSystem)
Wire Size	18AWG, 2 wire; 20AWG, 3 wire
Certification	<p>ETL - Conforms to UL Std. 2108; Certified to CSA Std. C22.2 No. 9.0.</p> <p>Title 24 - All White and Variable White Colors are JA8 2016 when used with 0-10V, DMX, Lutron A-Series (LN2), Lutron Premier (LN3) or VintageDim® (VIN) dimming.</p>

PHYSICAL

Operating Temperature	-20° C (-40°F) to +50°C (+122°F)
Environment	IP20 - Dry Location
Diameter	Ø 1 5/16"
Max Length	6.31'
Finish	Satin Silver Anodized, Deep Bronze Anodized ⁹ , Matte Black Anodized ⁹ , White Powder Coat ⁹ , Custom RAL Power Coat ⁹ , Chrome ⁹

9: Special order finishes. Additional charges and longer lead times may apply.

TYPES

1 Single - Maximum overall length of 6.33' (6.00' luminous length).

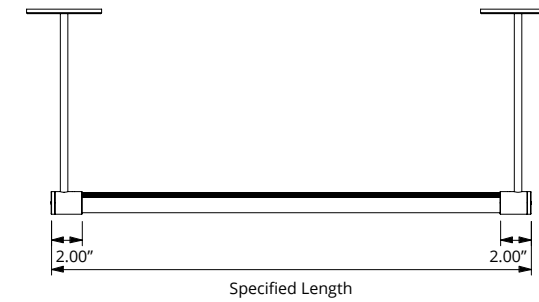

2 Continuous Row Mount

- Unlimited run length with power refeeds
- All sections built to equal length as standard.
- Feed accessories provided as needed
- Contact factory for custom options.

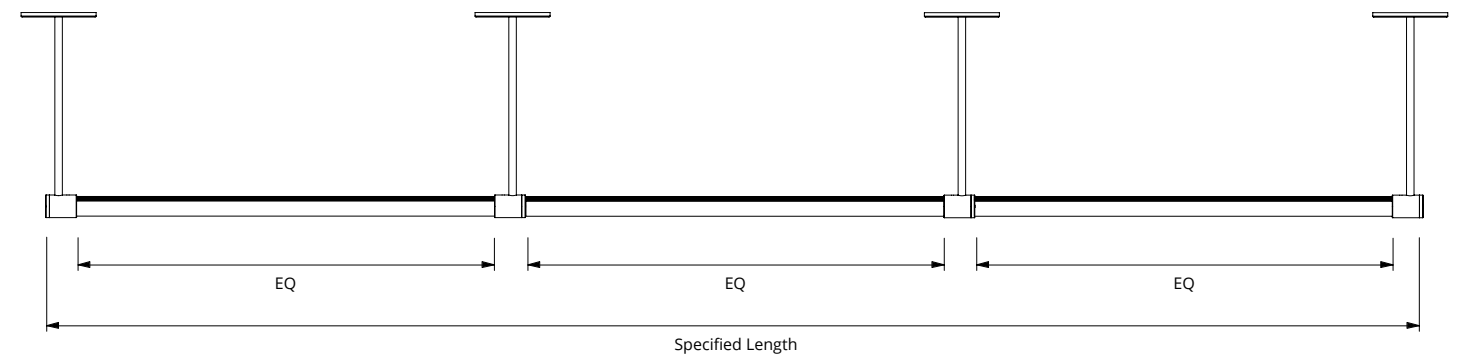

3 Center Mount

- Maximum overall length of 3.18' (1.50' luminous length per side)

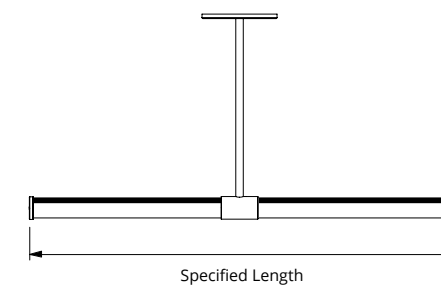

WIRING DIAGRAMS

LARGE ROUND CANOPY

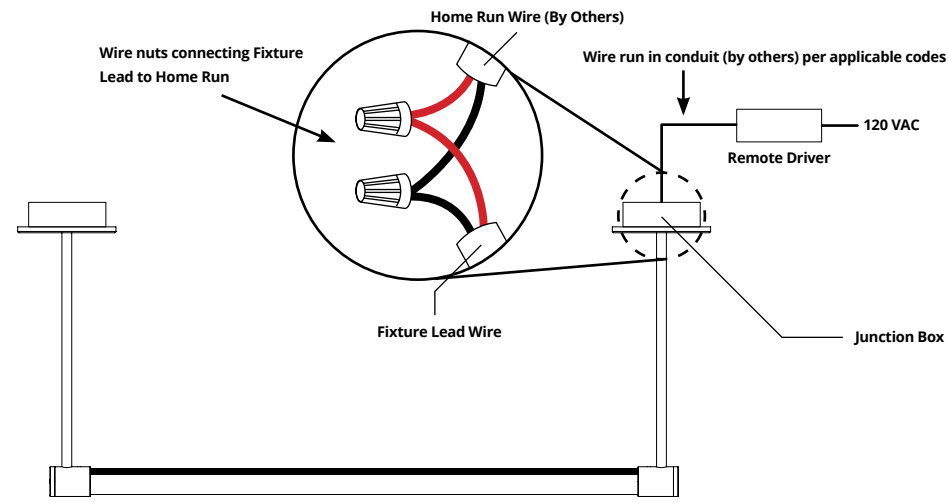

SMALL ROUND CANOPY

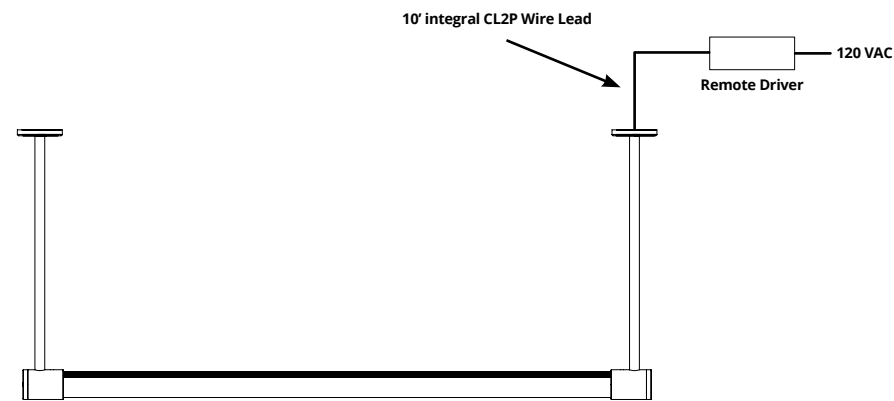

COMPATIBLE DRIVERS

PURE DC® LITE (PDCL)

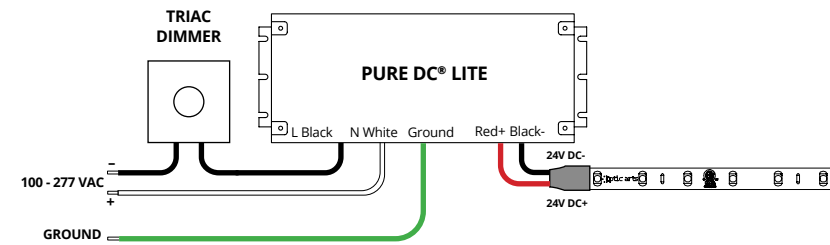
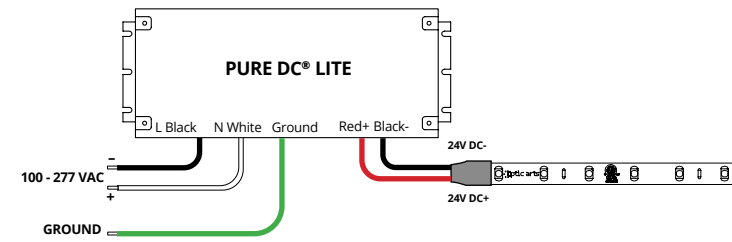

PART	DESCRIPTION
PDCL.30.24	30W 100-277VAC DIMMABLE DRIVER
PDCL.60.24	60W 100-277VAC DIMMABLE DRIVER
PDCL.96.24	96W 100-277VAC DIMMABLE DRIVER

DIMENSIONS	
PDCL.30.24	H 1.03"; W 6.50"; D 3.62"
PDCL.60.24	H 1.03"; W 7.40"; D 3.62"
PDCL.96.24	H 1.61"; W 8.66"; D 3.66"

DIMMING PERFORMANCE
PURE DC® LITE DRIVER Dims to 1% on most MLV dimmers
 NOTE: Must be loaded at least 10% of rated load to obtain optimal dimming.

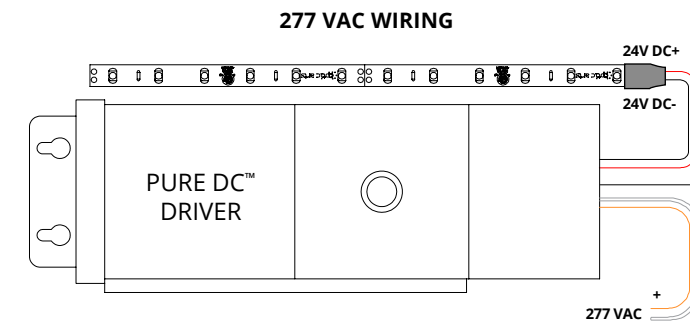
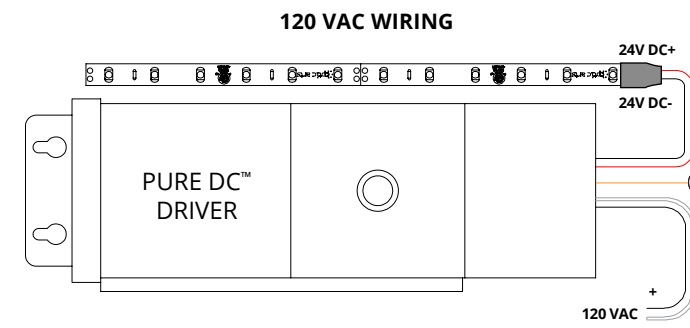

PURE DC™ MLV (PDC)

PART	DESCRIPTION
PDC.40.24	40W 120/277VAC PURE DC™ MLV DIMMABLE DRIVER
PDC.96.24	96W 120/277VAC PURE DC™ MLV DIMMABLE DRIVER

DIMENSIONS	
40W	L 14.25"; W 3.00"; H 2.88"
96W	L 14.75"; W 4.31"; H 4.81"

DIMMING PERFORMANCE
PURE DC™ DRIVER Dims to 0.1% on most MLV dimmers

COMPATIBLE DRIVERS

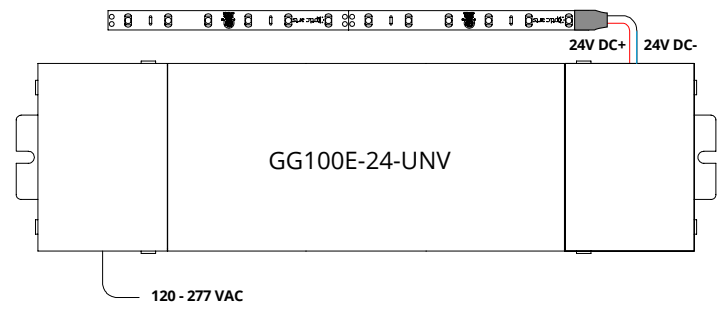

ELECTRONIC DRIVER - NON-DIM (ND)

PART	DESCRIPTION
GG100E-24-UNV	96W 120-277VAC ELECTRONIC DRIVER
DIMENSIONS	
ELECTRONIC DRIVER	H 3.00"; W 11.46"; D 1.30"
DIMMING PERFORMANCE	
ELECTRONIC DRIVER	Non-Dim

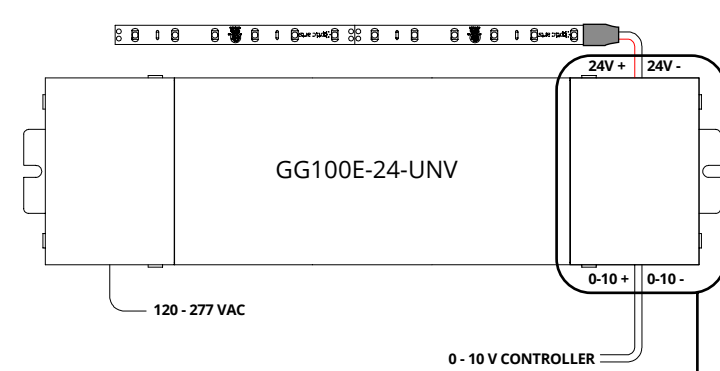

ELECTRONIC DRIVER W/0-10V MODULE (010)

PART	DESCRIPTION
GG100E-24-UNV-010V	96W 120-277VAC ELECTRONIC DRIVER WITH 0-10V DIMMING MODULE (SINK)
DIMENSIONS	
ELECTRONIC DRIVER - 0-10V	H 3.00"; W 11.46"; D 1.30"
DIMMING PERFORMANCE	
ELECTRONIC DRIVER - 0-10V	Dims below 1% on most 0-10V dimmers

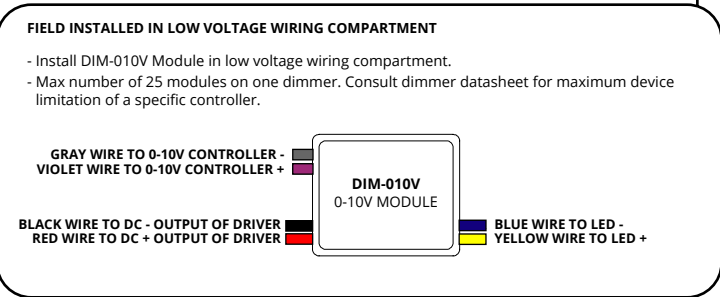

COMPATIBLE DRIVERS

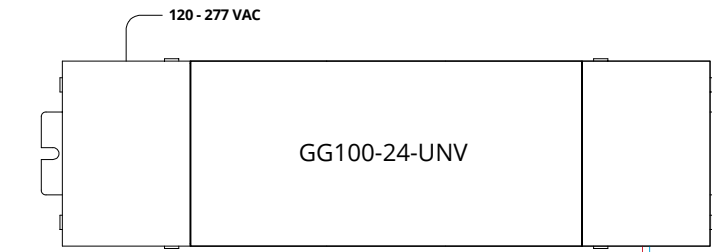

ELECTRONIC DRIVER W/DMX MODULE (DMX)

PART	DESCRIPTION
GG100E-24-UNV-DMX	96W 120-277VAC ELECTRONIC DRIVER WITH eldoLED DMX DIMMING MODULE
DIMENSIONS	
96W	H 3.00"; W 11.46"; D 1.30"
DMX MODULE	H 1.97"; W 6.02"; D 0.91"

**Must be installed in UL box (by others)*

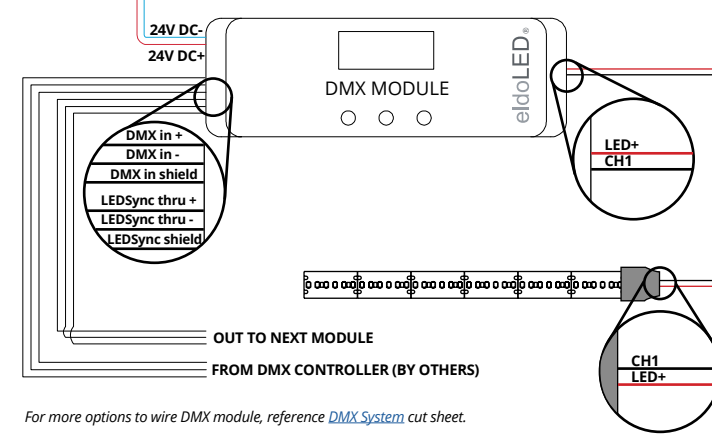

DIMMING PERFORMANCE

ELECTRONIC DRIVER - DMX MODULE	Dims to 0.1% on most DMX systems
--------------------------------	----------------------------------

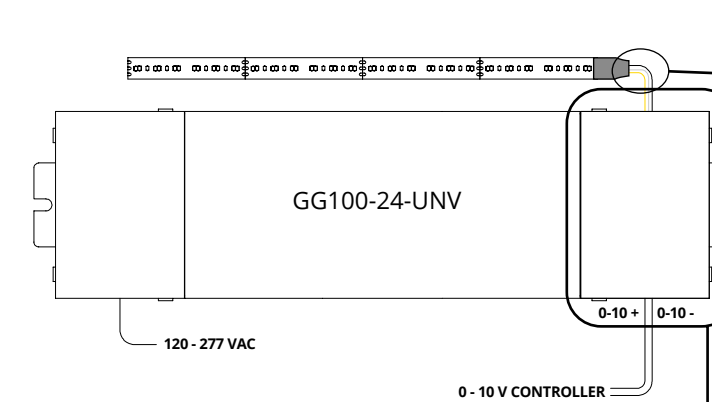

ELECTRONIC DRIVER W/VintageDim® MODULE (VIN)

PART	DESCRIPTION
GG100E-24-UNV-W	96W 120-277VAC ELECTRONIC DRIVER WITH VINTAGEDIM® DIMMING MODULE STANDARD DIM TO WARM CURVE
GG100E-24-UNV-C	96W 120-277VAC ELECTRONIC DRIVER WITH VINTAGEDIM® DIMMING MODULE CUSTOM CURVE
DIMENSIONS	
ELECTRONIC DRIVER	H 3.00"; W 11.46"; D 1.30"
VintageDim® MODULE	H 1.56"; W 1.56"; D 0.78"

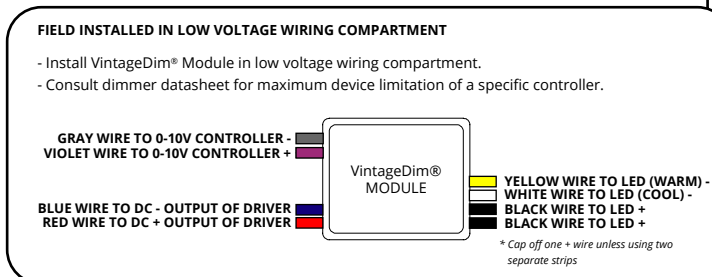

DIMMING PERFORMANCE

ELECTRONIC DRIVER - VintageDim®	Dims below 1% on most 0-10V dimmers
---------------------------------	-------------------------------------

COMPATIBLE DRIVERS

DIMMER WITH NEUTRAL

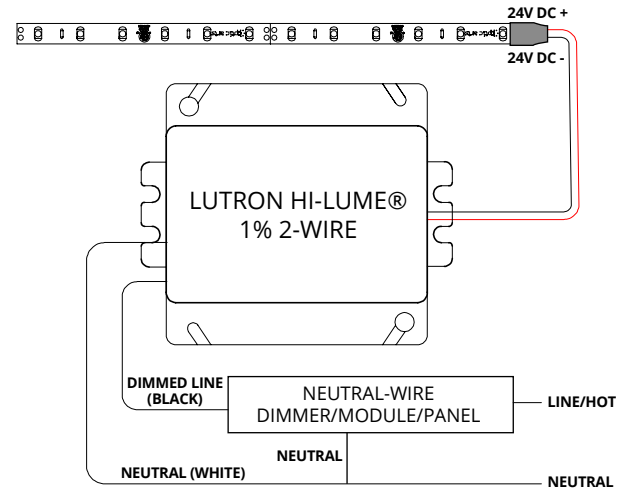

LUTRON HI-LUME® 1% 2-WIRE (LN2):
2-WIRE CONTROL FORWARD PHASE



PART	DESCRIPTION
LTEA4U1UKL-CV240	5-40W, 120VAC, 2-WIRE FORWARD PHASE DRIVER

DIMENSIONS	
LUTRON HI-LUME® 1% 2-WIRE	H 4.00"; W 4.89"; D 2.62"

DIMMING PERFORMANCE	
LUTRON HI-LUME® 1% 2-WIRE	Dims to 1% with compatible Lutron controls

DIMMER WITHOUT NEUTRAL

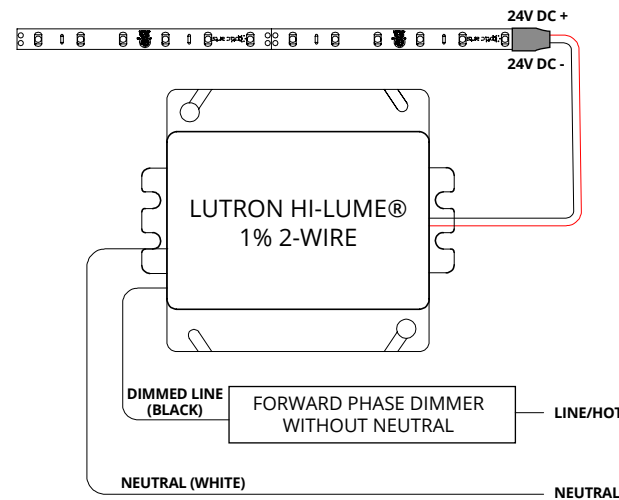

COMPATIBLE DRIVERS

3-WIRE

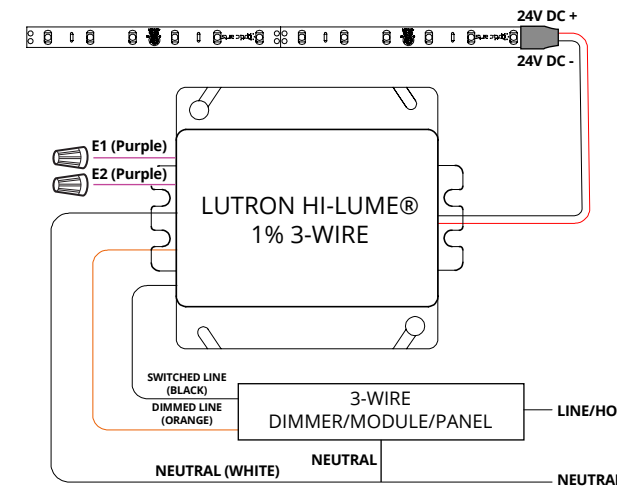

LUTRON HI-LUME® 1% (LN3):
3-WIRE/ECOSYSTEM



PART	DESCRIPTION
L3DA4U1UKL-CV240	5-40W, 120-277VAC, 3-WIRE/ECOSYSTEM DRIVER

DIMENSIONS	
LUTRON HI-LUME® 1% 3-WIRE/ECOSYSTEM	H 4.00"; W 4.89"; D 2.62"

DIMMING PERFORMANCE	
LUTRON HI-LUME® 1% 3-WIRE/ECOSYSTEM	Dims to 1% with compatible Lutron controls

ECOSYSTEM

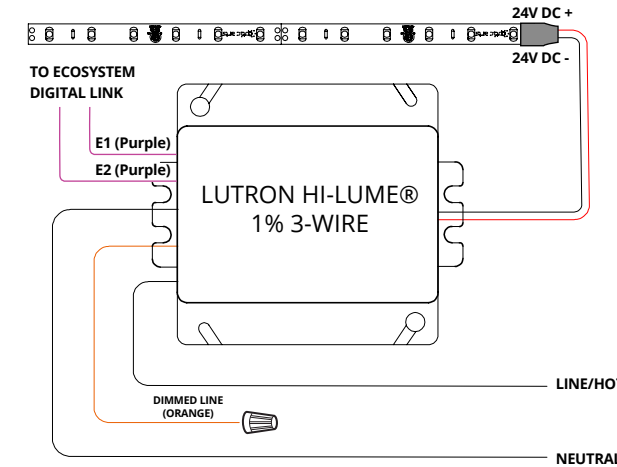

COMPATIBLE DRIVERS

3-WIRE

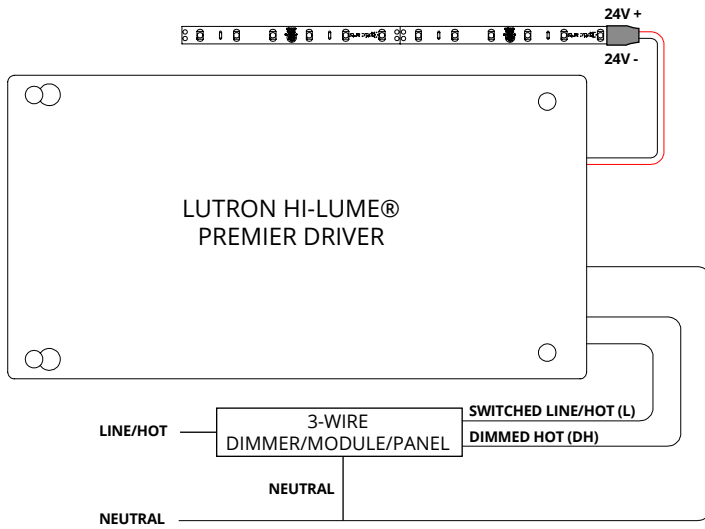

LUTRON HI-LUME® PREMIER (LNP):
3-WIRE/ECOSYSTEM



PART	DESCRIPTION
L3D0-96W24V-U	2-96W, 120-277VAC, 3-WIRE/ECOSYSTEM DRIVER

DIMENSIONS	
LUTRON HI-LUME® PREMIER	H 5.5"; W 10.5"; D 2.0"

DIMMING PERFORMANCE	
LUTRON HI-LUME® PREMIER	Dims to 0.1% with compatible Lutron controls

NOTE: Lutron soft-on, fade to black technology available with Ecosystem Digital Control only.

ECOSYSTEM

