

Features

- 24VDC Class 2 for wet locations fixtures made to order up to 144". Fixtures can be linked up to 35' depending on output
- Dot free even illumination achievable with frosted lens
- Vibrant colors with R9 values up to 98
- Single micro binned LEDs +/- 30 CCT
- Dims with minimal color shift
- Class 2 listed for wet locations
- 3 Year warranty

IP68



IC RATED

RoHS Compliant



Finish options

- Silver anodized
- Black powder coated
- Bronze powder coated
- White powder coated

Profile dimensions

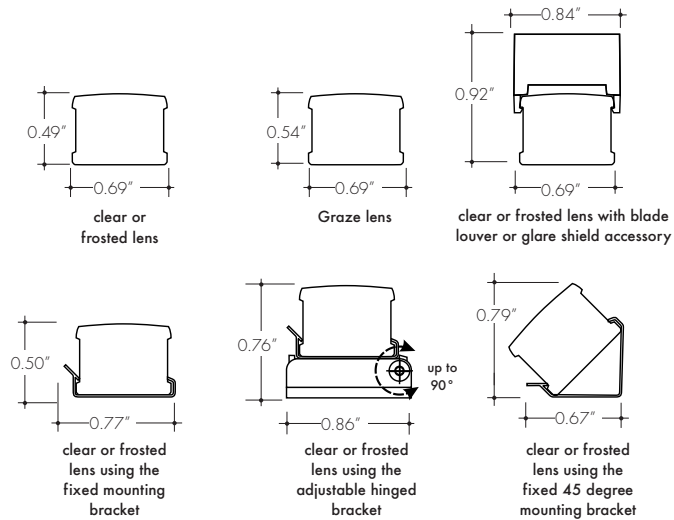

Technical information

OUTPUT OPTIONS

Output	Lumens at 4000K (with clear lens)	Average power consumption at 4'	Lumens / Watt (with clear lens)	Maximum system length In series
LO (LL18)	74	1.6 W/ft	46 lm/W	80'
SO (LL36)	149	3.2 W/ft	47 lm/W	35'
HO (LL54)	209	5.2 W/ft	40 lm/W	26'
VHO (LL72)	291	6.5 W/ft	45 lm/W	18'

CCT INFO/LUMEN MULTIPLIER

Color temperature	Multiplier (reference - 4000K)	CRI	R _f	R _g
2700K	0.73	97	95	101
3000K	0.81	91	89	98
3500K	0.86	94	90	102
4000K	1.00	94	86	96

TM-30-15

Ordering code

MODEL	LENGTH	CCT	OUTPUT	LENS	MOUNTING	FINISH	POWER FEED POSITION / TYPE	ACCESSORIES
KMW	12	27K	LO	C	FC	SA	E	BLS
<p>KMW Kendo M Wet 12" - 144" 4" increments 27K - 2700 K LO - Low C - Clear FC - Fixed clip SA - Silver E - End BLS - N/A, leave blank</p> <p>30K - 3000 K SO - Standard F - Frosted AH - Adjustable hinge mounting BK - Black B - Bottom BLS - Blade louver, Silver</p> <p>35K - 3500 K HO - High G - Graze FC45 - Fixed clip 45 degree BZ - Bronze BLBK - Blade louver, Black</p> <p>40K - 4000 K VHO - Very High WH - White [BK,BZ,WH finishes will have an upcharge and require longer lead times] S - Side BLWH - Blade louver, White</p> <p>1 - 72" wire leads 2 - 72" wire leads at both ends and quick connect at other 3 - Single quick connect 4 - Dual quick connect</p> <p>GSS - Glare shield, Silver GSBK - Glare shield, Black GSWH - Glare shield, White</p>								

Power consumption per fixture length

Based on operation with PSD series of power supplies.

Nominal Length	Actual Length	LO		SO			HO			VHO		
		W/ft	Total wattage	Actual Length	W/ft	Total wattage	Actual Length	W/ft	Total wattage	Actual Length	W/ft	Total wattage
12"	12-12/16"	1.65	1.65	12-12/16"	3.25	3.25	12-11/16"	5.35	5.30	12-11/16"	6.75	6.75
16"	16-11/16"	1.65	2.00	16-10/16"	3.25	4.00	16-10/16"	5.33	7.06	16-9/16"	6.75	9.00
20"	20-10/16"	1.65	2.80	20-10/16"	3.25	5.25	20-10/16"	5.31	8.82	20-9/16"	6.75	11.25
24"	24-8/16"	1.65	3.00	24-8/16"	3.25	6.50	24-9/16"	5.30	10.60	24-8/16"	6.75	13.50
28"	28-7/16"	1.65	3.90	28-7/16"	3.25	7.75	28-7/16"	5.28	12.33	28-7/16"	6.75	16.75
32"	32-6/16"	1.65	4.00	32-7/16"	3.25	8.50	32-7/16"	5.26	14.06	32-6/16"	6.75	19.00
36"	36-6/16"	1.65	5.00	36-5/16"	3.25	9.75	36-6/16"	5.25	15.80	36-5/16"	6.65	19.95
40"	40-4/16"	1.64	5.50	40-4/16"	3.25	10.25	40-5/16"	5.23	17.40	41-4/16"	6.65	22.20
44"	44-3/16"	1.64	6.00	44-4/16"	3.20	11.75	44-4/16"	5.21	19.00	45-3/16"	6.65	24.40
48"	48-2/16"	1.63	6.60	48-3/16"	3.20	12.80	48-3/16"	5.20	20.60	49-2/16"	6.55	26.20
52"	52-1/16"	1.63	7.10	52-2/16"	3.20	13.30	53-7/16"	5.18	22.40	53-1/16"	6.55	28.50
56"	56-1/16"	1.63	7.70	56-1/16"	3.20	14.80	57-6/16"	5.16	24.20	57 "	6.55	30.50
60"	59-15/16"	1.63	8.20	60 "	3.20	16.00	61-5/16"	5.15	26.00	60-15/16"	6.45	32.25
64"	63-14/16"	1.63	8.80	63-15/16"	3.20	17.00	65-4/16"	5.13	27.60	64-14/16"	6.45	34.40
68"	67-13/16"	1.62	9.30	69-13/16"	3.15	18.00	69-3/16"	5.11	29.20	68-13/16"	6.45	36.55
72"	71-12/16"	1.62	9.80	73-12/16"	3.15	18.90	73-2/16"	5.10	30.80	72-12/16"	6.40	38.40
76"	75-12/16"	1.62	10.40	77-11/16"	3.15	19.00	77-1/16"	5.08	32.40	76-11/16"	6.40	40.50
80"	79-10/16"	1.62	10.90	81-11/16"	3.15	21.50	81-1/16"	5.06	34.00	80-10/16"	6.40	43.00
84"	83-9/16"	1.62	11.50	85-9/16"	3.15	22.05	85"	5.05	35.70	84-9/16"	6.25	43.75
88"	87-8/16"	1.62	12.00	89-8/16"	3.15	23.00	88-14/16"	5.03	37.10	88-8/16"	6.25	46.00
92"	91-7/16"	1.62	12.50	93-7/16"	3.10	24.00	92-13/16"	5.01	38.50	92-7/16"	6.25	48.00
96"	95-7/16"	1.62	13.10	97-6/16"	3.10	24.80	96-13/16"	5.00	40.00	97-6/16"	6.15	49.20
100"	99-5/16"	1.61	13.50	101-6/16"	3.10	26.30	100-12/16"	4.98	41.60	101-5/16"	6.15	51.25
104"	103-4/16"	1.61	14.00	105-4/16"	3.05	27.10	104-11/16"	4.96	43.20	105-3/16"	6.15	53.00
108"	111-2/16"	1.60	14.50	109-4/16"	3.05	28.00	108-10/16"	4.95	44.80	109-3/16"	6.00	54.00
112"	115-2/16"	1.60	15.00	113-3/16"	3.05	28.50	112-9/16"	4.93	46.20	113-2/16"	6.00	56.00
116"	119"	1.59	15.50	117-1/16"	3.05	30.00	116-8/16"	4.91	47.60	117-1/16"	6.00	58.00
120"	122-15/16"	1.59	16.50	121-1/16"	3.00	30.50	120-8/16"	4.90	48.90	121 "	5.90	59.00
124"	126-14/16"	1.59	17.00	125 "	3.00	31.50	124-7/16"	4.88	50.40	124-15/16"	5.90	60.60
128"	130-13/16"	1.59	17.50	128-14/16"	3.00	32.50	128-6/16"	4.86	51.90	128-14/16"	5.90	62.20
132"	134-13/16"	1.59	18.10	132-14/16"	2.95	33.50	132-5/16"	4.85	53.30	132-13/16"	5.80	63.80
136"	138-11/16"	1.59	18.60	136-13/16"	2.95	34.30	136-4/16"	4.83	54.70	136-12/16"	5.80	65.30
140"	142-10/16"	1.59	19.10	140-12/16"	2.95	35.20	140-3/16"	4.81	56.10	140-11/16"	5.80	66.80
144"	146-10/16"	1.58	19.64	144-11/16"	2.90	36.00	145-7/16"	4.80	57.40	144-10/16"	5.70	68.40

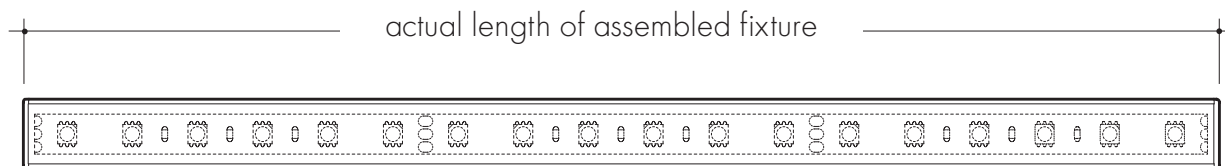

Connectors

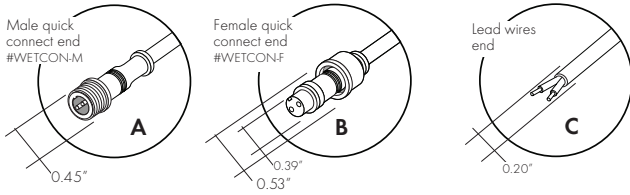

Linking and Extension Cable

Male/female Joiner 12" - Part # IP67-12

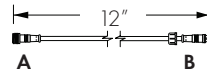

Male/female Joiner 48" - Part # IP67-48

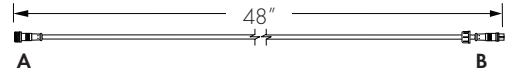

Powerfeed options with fixed bracket

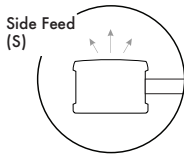
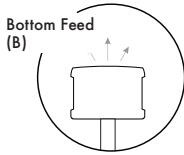
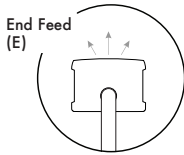

72" wire leads (1)

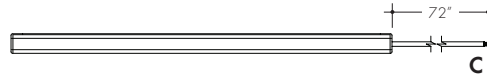

72" wire leads at one end and quick connect at other (2)

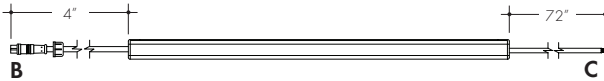

Single quick connect (3)

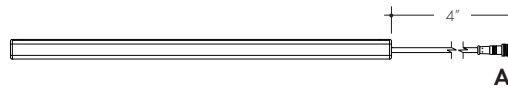

Dual quick connect (4)

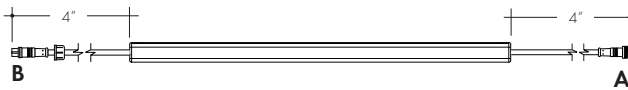

Accessory options

Glare Shield:
redirect the light to avoid glare from fixture
*available only with complete fixture
reference page 1 ordering code*

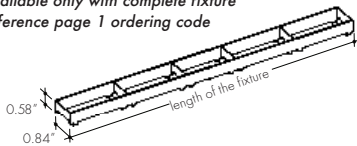

Blade Louver:
control light distribution
*available only with complete fixture
reference page 1 ordering code*

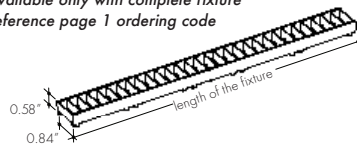

Splice Box:
Wet rated, low voltage
splice box, gray
Part # LVSP-WET

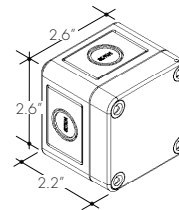

Connector:
Low voltage splice box
wet cable management
gray
Part # LVSP-WET-CM

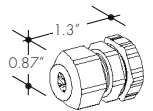

Sample layout of powerfeed connections

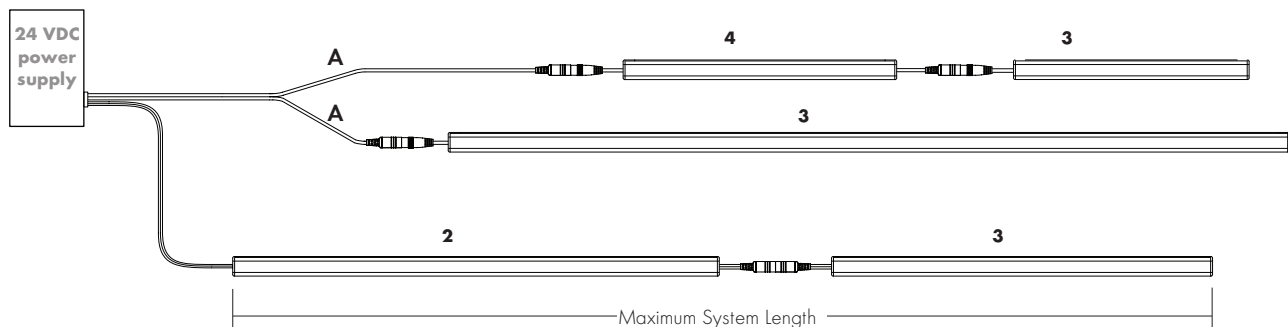

Power supply

See fixture and power supply instructions & spec sheet for wiring information. Dimming possible in select models - view Luminii website for list of compatible dimmers.

Magnetic Low Voltage Dimming Power Supplies:

MODEL	POWER	OUTPUT	INPUT
PSD	48	24	
PSD - PSD Series dims down to 0%	48 - 48 W 96 - 96 W 288 - 288 W (3x 96W)	24 - 24 VDC	Blank - 120 V 240 - 240 V 277 - 277 V

MODELS	PSD 48	PSD 96	PSD 288
A Length	11.25"	11.25"	13.06"
B Width	3.42"	3.42"	8.42"
C Depth	3.42"	3.27"	4.47"

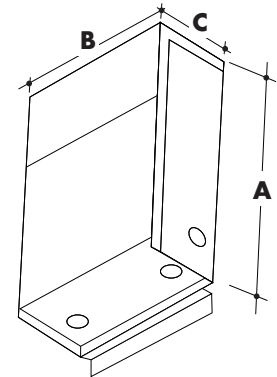

Electronic Low Voltage Dimming Power Supplies:

MODEL	CIRCUIT x POWER	OUTPUT	INPUT
CVE	48D	24	
CVE - CVE Series dims down to 0.1%	48D - 48W 48X2D - 2 x 48W 48X3D - 3 x 48W 48X4D - 4 x 48W 96D - 96W 96X2D - 2 x 96W 96X3D - 3 x 96W 96X4D - 4 x 96W	24 - 24 VDC	Blank - 120 V 277 - 240/277 V

MODELS	Single circuit	Dual circuit	Three circuit	Four circuit
A Length	13.9"	13.8"	13.8"	13.8"
B Width	2.3"	4.0"	5.9"	7.75"
C Depth	1.3"	1.9"	1.9"	1.9"

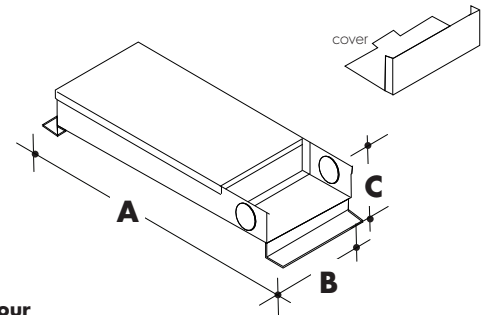

0-10V Dimming Power Supplies:

MODEL	POWER	OUTPUT	DIMMING
PSO10V	3X96	24	LIN
PSO10V - 0-10V Power Supply dims down to 0%	96 - 96 WATT 3X96 - 3 X 96 WATT	24 - 24 VDC	LIN - Linear LOG - Logarithmic

MODELS	96 W	3X96
A Length	14.40"	15.75"
B Width	5.20"	6.60"
C Depth	2.60"	4.80"

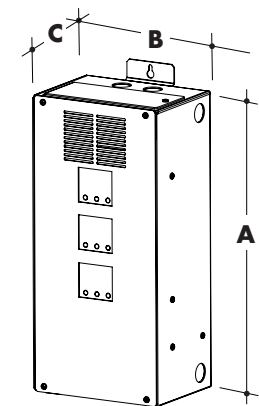

MODEL	POWER	OUTPUT	DIMMING	LOCATION
PSV	40	24	U2DIM	D
PSV - PSV Series dims down to 5%	40 - 40 W 60 - 60 W 96 - 96 W	24 - 24 VDC	U2DIM - Dimming 0-10V	D - Dry Location IP65 - Wet Location

MODELS	PSV Dry	PSV Wet
A Length	9.2"	9.5"
B Width	3.4"	4.12"
C Depth	1.9"	2.3"

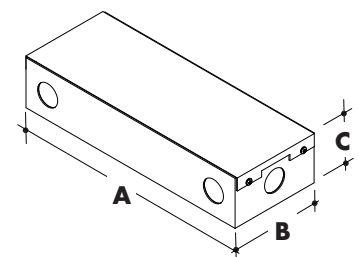

Power supply

See fixture and power supply instructions & spec sheet for wiring information. Dimming possible in select models - view Luminii website for list of compatible dimmers.

DMX Dimming Power Supplies:

MODEL	POWER	OUTPUT
PSDMX	96	24
PSDMX - DMX Power Supply	96 - 96 WATT 3X96 - 3 X 96 WATT	24 - 24 VDC

- Features eldoLED's LINEARdrive configurable dimmable drivers

MODELS	3X96 W
A Length	15.75"
B Width	6.60"
C Depth	4.80"

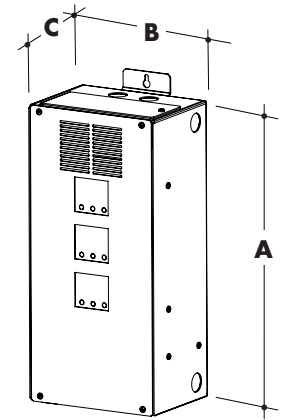

DALI Dimming Power Supplies:

MODEL	POWER	OUTPUT
PSDALI	96	24
PSDALI - DALI Power Supply dims down to 0%	96 - 96 WATT 3X96 - 3 X 96 WATT	24 - 24 VDC

- Features eldoLED's LINEARdrive configurable dimmable drivers

MODELS	96 W
A Length	14.40"
B Width	5.20"
C Depth	2.60"

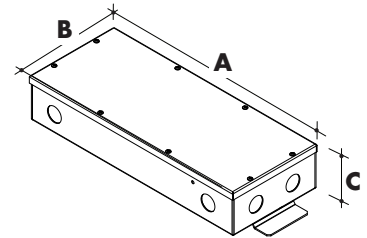

Luminii is a Lutron OEM Advantage Partner

MODEL	L7EA4U1UKL-CV240	
Lutron - Hi-lume™ 1% 2-wire LED driver (120V forward phase only)		

MODELS	L7EA	L7DA
A Length	4.89"	4.89"
B Width	2.66"	2.66"
C Depth	4.00"	4.00"

MODEL	L3DA4U1UKL-CV240	
Hi-lume™ 1% EcoSystem Voltage LED Driver		

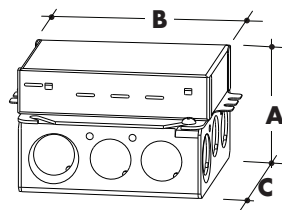

MODEL	L3D0-96W24V-U	
Hi-lume™ 0.1% EcoSystem Voltage LED Driver with Soft-On, Fade-to-Black™		

MODELS	L3D0
A Length	10.50"
B Width	5.50"
C Depth	2.00"

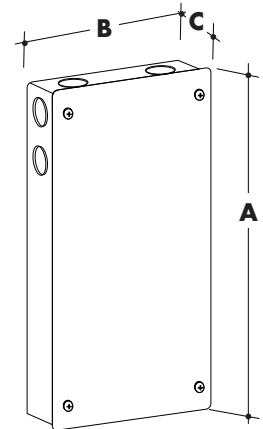

Power supply

See fixture and power supply instructions & spec sheet for wiring information. Dimming possible in select models - view Luminii website for list of compatible dimmers.

Enlighted Enabled Dimming Power Supplies:

MODEL	POWER	OUTPUT	DIMMING	Location
PSV	96	24	ENL	D
PSV - LED Power Supply	96 - 96 WATT	24 - 24 VDC	ENL - Enlighted Dimming	D - Damp

MODELS	96 W
A Length	14.40"
B Width	5.20"
C Depth	2.60"

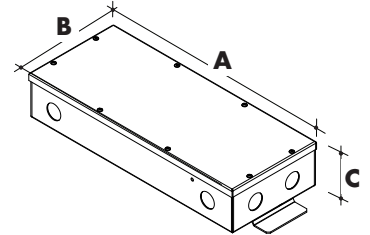

Non-Dimming Power Supplies:

MODEL	POWER	OUTPUT	DIMMING	LOCATION
PSV	40	24	U2ND	D
PSV - PSV Series	40 - 40 W 60 - 60 W 96 - 96 W	24 - 24 VDC	U2ND - Non Dimming	D - Dry Location IP65 - Wet Location

MODELS	PSV Dry	PSV Wet
A Length	9.2"	9.5"
B Width	3.4"	4.12"
C Depth	1.9"	2.3"

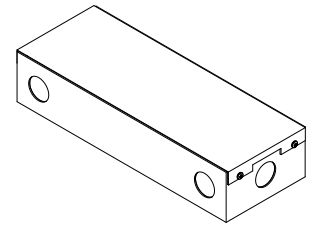

In ground, Electronic Low Voltage Dimming Power Supplies:

MODEL	CIRCUIT x POWER	OUTPUT	INPUT
IG-CVE	96X2	24	
IG-CVE - In ground CVE Series dims down to 0.1%	96X2 - 2 x 96W	24 - 24 VDC	Blank - 120 V 277 - 240/277 V

MODELS	Dual circuit
A Length	8.0"
B Width	8.0"
C Depth	8.0"

