

**Please read complete instruction prior to installation  
and keep for future reference!**

Kurba Horizontal

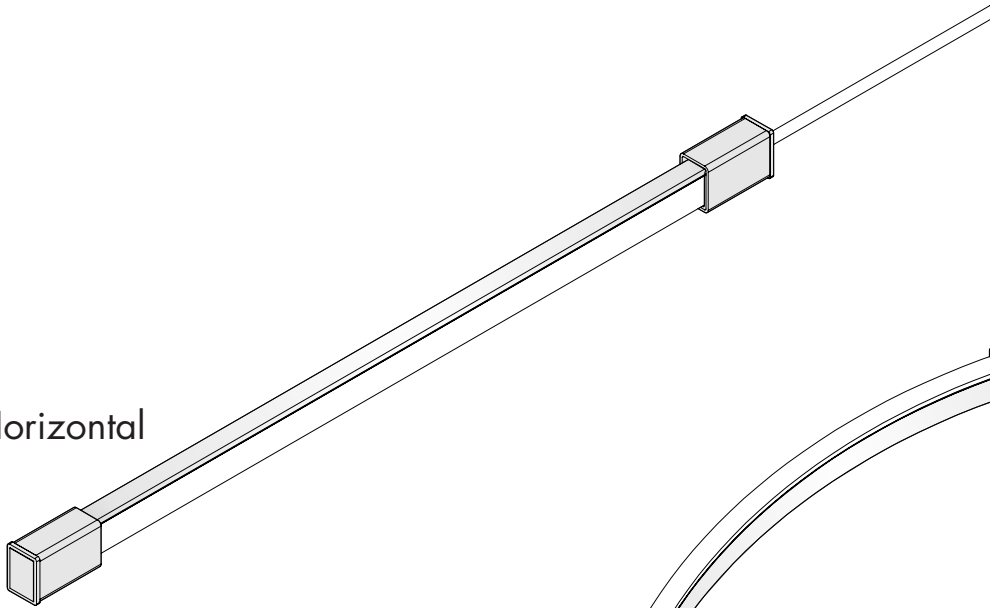

Kurba Vertical

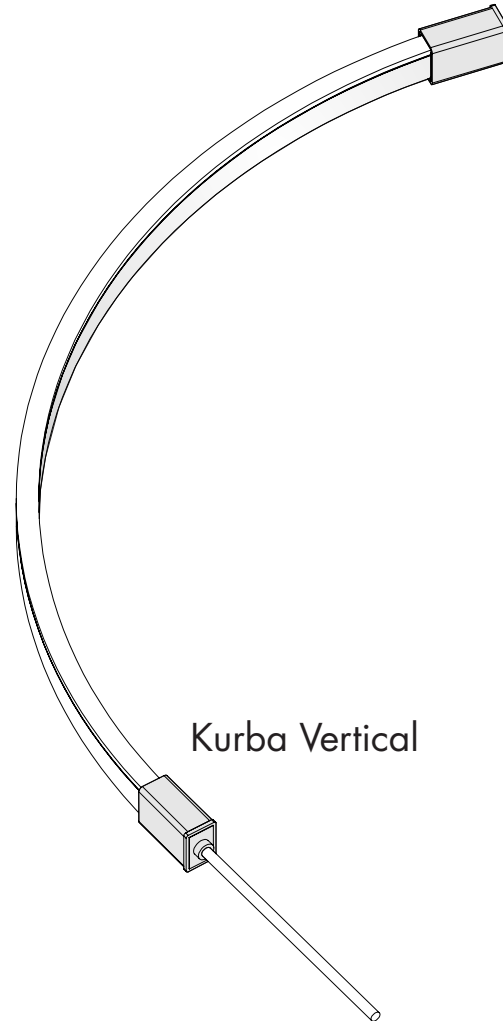

# Installation Instructions for Kurba Vertical & Kurba Horizontal

Models KBL-XX & KBM-XX

**Please read complete instruction prior to installation and keep for future reference!**

1. PRODUCT TO BE INSTALLED BY A QUALIFIED ELECTRICIAN.
2. USE ONLY WITH CLASS 2 POWER UNIT
3. 24 VOLTS DC
4. SUITABLE FOR WET LOCATIONS
5. SURFACE MOUNT ONLY



7777 N. Merrimac Ave  
Niles, IL 60714  
T 224.333.6033  
F 224.757.7557  
info@luminii.com  
www.luminii.com

Page 2 of 4

**CAUTION: Reference diagram below on Can and Can-nots, when it comes to installing the Kurba Horizontal & Vertical !!!**

## Kurba Horizontal (KBM-XX)

## Kurba Vertical (KBL-XX)

### CAN

bend LED in these positions only to avoid damage

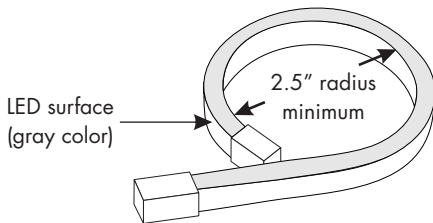

bend in this direction only

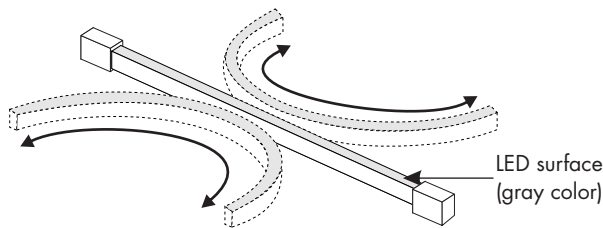

### CAN

bend LED in these positions only to avoid damage

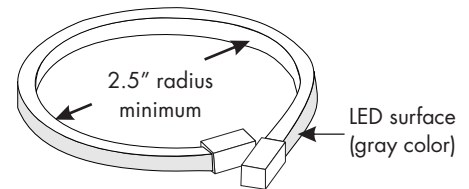

bend in this direction only

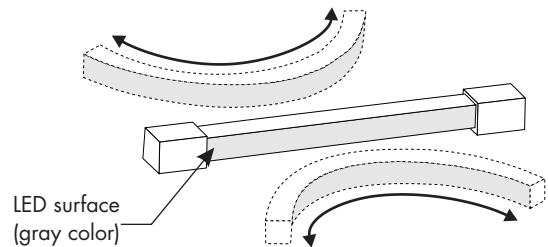

### CAN-NOTS

twisting or bending LED in these positions will cause damage to the LED

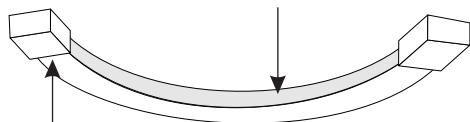
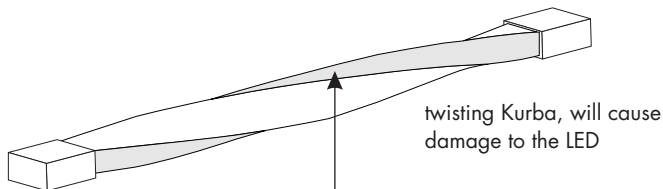

Do not make sharp bends, near the endcap

bending in the same direction as the LED, will cause damage to the LED.

### CAN-NOTS

twisting or bending LED in these positions will cause damage to the LED

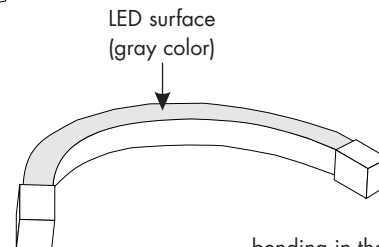
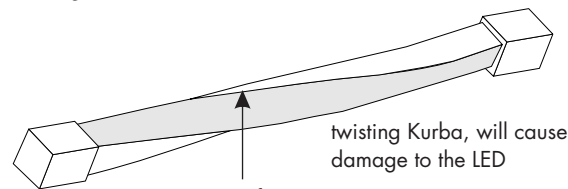

Do not make sharp bends, near the endcap

bending in the same direction as the LED, will cause damage to the LED.

# Installation Instructions for Kurba Vertical & Kurba Horizontal

Models KBL-XX & KBM-XX

**Please read complete instruction prior to installation and keep for future reference!**

1. PRODUCT TO BE INSTALLED BY A QUALIFIED ELECTRICIAN.
2. USE ONLY WITH CLASS 2 POWER UNIT
3. 24 VOLTS DC
4. SUITABLE FOR WET LOCATIONS
5. SURFACE MOUNT ONLY



7777 N. Merrimac Ave  
Niles, IL 60714  
T 224.333.6033  
F 224.757.7557  
info@luminii.com  
www.luminii.com

Page 3 of 4

**1**

**Note:** Prior to installation all 24VDC wires must be present within 72" of the installation. Refer to the power supply installation instruction for additional information.

**Note:** More than one person is recommended for this installation.

- 1.1** Once the location or pattern is determined for Kurba to be installed too. Start off by marking the area, depending on the pattern of installation the amount of bracket may vary. Reference one of the options below to continue.

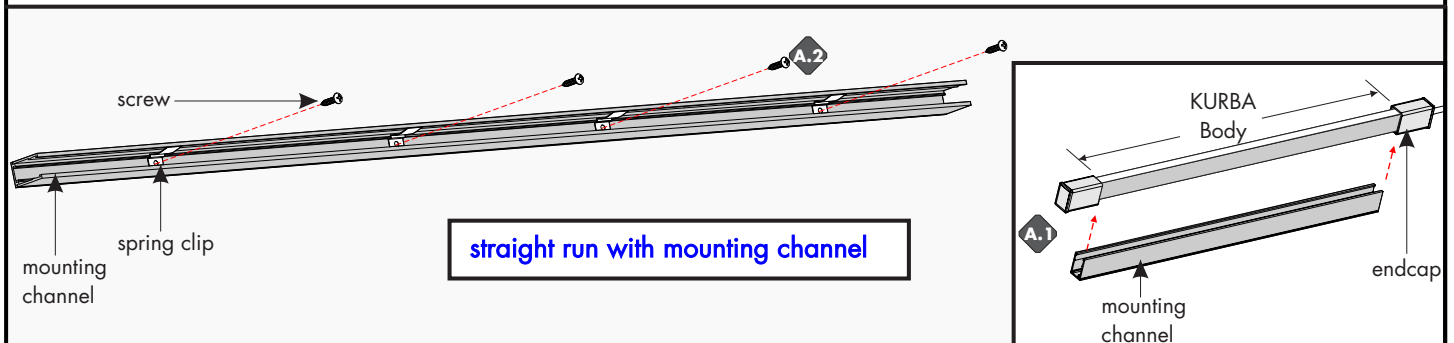

**straight run with mounting channel**

- A.1** Line up the spring clips to the mounting holes. Followed by placing the mounting channel to the surface. Make sure its straight by using a level. **Mounting channel will only house the Kurba body (not the endcaps), refer to illustration above.**

- A.2** Secure channel to the surface by tightening all the provided screws. If mounting to something other than wood, we recommend using the proper hardware.

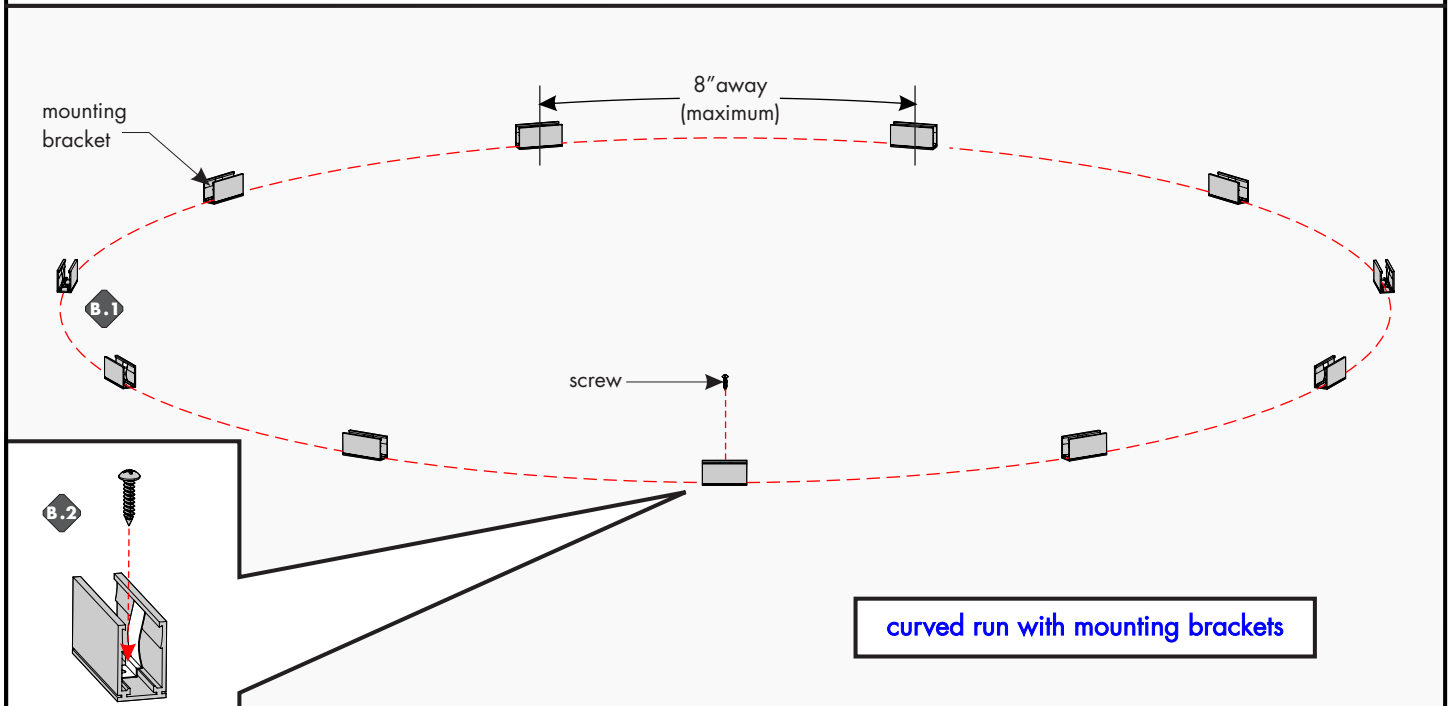

**curved run with mounting brackets**

- B.1** Determine the shape of the Kurba layout, then mark the pattern onto the surface. Then place a mounting brackets every 8" (minimum), on the pattern may vary depending on the amount of curves.

- B.2** Secure the mounting brackets to the surface by tightening the screw. If mounting to something other than wood, we recommend using the proper hardware.

# Installation Instructions for Kurba Vertical & Kurba Horizontal

Models KBL-XX & KBM-XX

**Please read complete instruction prior to installation and keep for future reference!**

1. PRODUCT TO BE INSTALLED BY A QUALIFIED ELECTRICIAN.
2. USE ONLY WITH CLASS 2 POWER UNIT
3. 24 VOLTS DC
4. SUITABLE FOR WET LOCATIONS
5. SURFACE MOUNT ONLY



7777 N. Merrimac Ave  
Niles, IL 60714  
T 224.333.6033  
F 224.757.7557  
info@luminii.com  
www.luminii.com

