



Features

- Efficacy up to 110 lm/w - a 57% increase over the standard KL model
- 24VDC Class 2 fixtures made to order up to 144". Fixtures can be linked up to 55' depending on output
- Suitable for undercabinet, millwork recessed and surface mount applications
- Approved for closet/storage space installation per NEC 410.16(A)(3) and 410.16(C)(5)
- Single micro binned LEDs +/- 30 CCT
- Dims with minimal color shift
- Class 2 listed for damp locations
- Proprietary strong bond solder method handles up to 50lbs of torque on wire leads and connectors
- 5 Year warranty

Finish options



Silver anodized



Black powder coated



Bronze powder coated

White powder coated

Profile dimensions

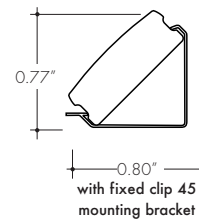
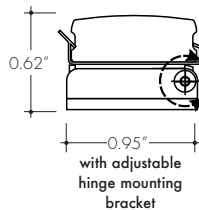
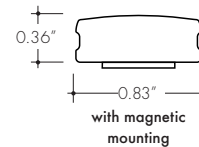
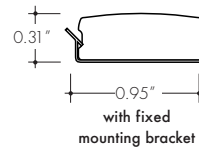

Technical information

OUTPUT OPTIONS

Output	Lumens at 3000K (with clear lens)	Average power consumption at 4'	Lumens / Watt (with clear lens)	Maximum system length In series
LO (LL48HE-LO)	212 lm/ft	2.0 W/ft	106 lm/W	55'
SO (LL48HE-SO)	301 lm/ft	2.8 W/ft	108 lm/W	38'
MO (LL48HE-MO)	403 lm/ft	3.7 W/ft	109 lm/W	27'
HO (LL48HE-HO)	647 lm/ft	5.9 W/ft	110 lm/W	17'

CCT INFO/LUMEN MULTIPLIER

Color temperature	Multiplier (referenced from 3000K)	CRI	R _f	R _g
2700K	0.94	92	90	99
3000K	1.00	92	89	99
3500K	1.02	92	89	99
4000K	1.02	92	86	94

TM-30-15

Ordering code

MODEL	LENGTH	CCT	OUTPUT	LENS	MOUNTING	FINISH	POWER FEED POSITION / TYPE	
KL - Kendo L	HE - High Efficacy	12 - 12" - 144" 4" increments	27K - 2700 K 30K - 3000 K 35K - 3500 K 40K - 4000 K	LO - Low SO - Standard MO - Medium HO - High	C - Clear F - Frosted HF - Half Frosted	FC - Fixed clip AH - Adjustable hinge mounting FC45 - Fixed clip 45 degree MAG - Magnetic	SA - Silver BK - Black BZ - Bronze WH - White [BK, BZ, WH finishes will have an upcharge and require longer lead times]	E - End B - Bottom
							1 - 72" wire leads 1X2 - 72" wire leads at both ends 2 - 72" wire leads at one end and quick connect at other 3 - Single quick connect 4 - Dual quick connect	

Photometry

KL-HE-48-30K-HO-C-XX

KL-HE-48-30K-HO-F-XX

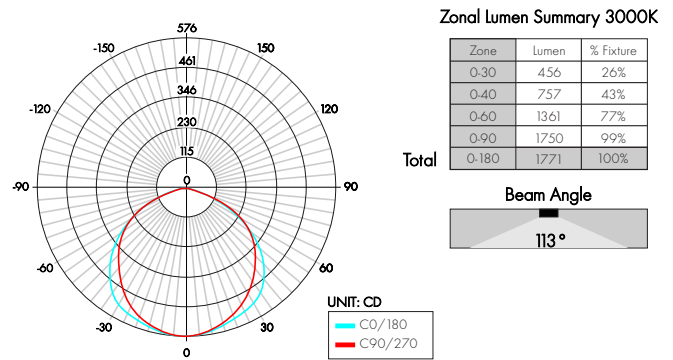
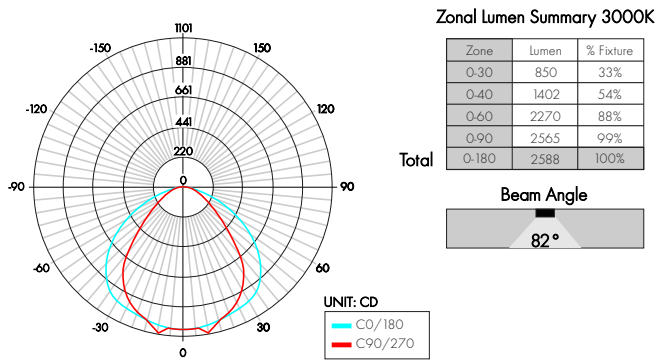

Light Transmission

Lens/Accessory	Percentage Light Transmission
clear lens	100%
half-frosted lens	76%
frosted lens	60%

LED Dotting per extrusion

output	Lens		
	Clear	Half - Frosted	Frosted
LO (LL48HE)	CD	CD	SD
SO (LL48HE)	CD	CD	SD
MO (LL48HE)	CD	CD	SD
HO (LL48HE)	CD	CD	SD

CD = Clear Dotting
 SD = Slight Dotting
 ND = No Dotting

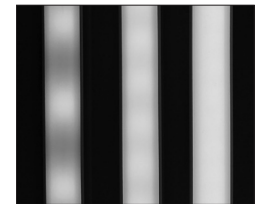

Clear Dotting Slight Dotting NO Dotting

Power consumption per fixture length

Based on operation with PSD series of power supplies.

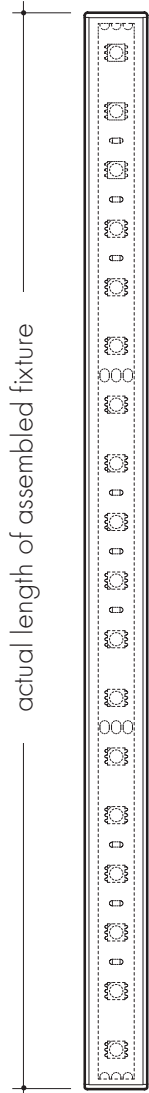

Length		LO		SO		MO		HO	
Nominal	Actual	W/ft	Total wattage	W/ft	Total wattage	W/ft	Total wattage	W/ft	Total wattage
12"	12-10/16"	2.00	2.00	2.79	2.79	3.70	3.70	5.90	5.90
16"	16-9/16"	2.00	2.67	2.79	3.72	3.70	4.90	5.90	7.88
20"	20-8/16"	2.00	3.33	2.79	4.65	3.70	6.10	5.90	9.86
24"	24-7/16"	2.00	4.00	2.79	5.58	3.70	7.40	5.90	11.84
28"	27-6/16"	2.00	4.67	2.79	6.51	3.70	8.63	5.91	13.81
32"	32-5/16"	2.00	5.34	2.79	7.44	3.70	9.83	5.91	15.78
36"	36-4/16"	2.00	6.00	2.79	8.37	3.70	11.10	5.91	17.75
40"	40-3/16"	2.00	6.66	2.79	9.30	3.70	12.33	5.92	19.74
44"	44-2/16"	2.00	13.33	2.79	10.23	3.70	13.56	5.92	21.73
48"	48-1/16"	2.00	8.00	2.79	11.16	3.70	14.80	5.92	23.72
52"	52 "	2.00	8.67	2.79	12.09	3.70	16.03	5.92	25.70
56"	55-15/16"	2.00	9.34	2.79	13.02	3.70	17.26	5.92	27.68
60"	59-14/16"	2.00	10.00	2.79	13.95	3.70	18.50	5.92	29.66
64"	63-13/16"	2.00	10.67	2.79	15.82	3.70	19.73	5.93	31.64
68"	67-12/16"	2.00	11.34	2.79	17.69	3.70	20.96	5.93	33.62
72"	71-11/16"	2.00	12.00	2.79	19.56	3.70	22.20	5.93	35.60
76"	75-10/16"	2.00	12.67	2.79	20.48	3.70	23.43	5.91	37.53
80"	79-9/16"	2.00	13.37	2.79	21.40	3.70	24.66	5.91	39.46
84"	83-8/16"	2.00	14.00	2.79	22.32	3.70	25.90	5.91	41.40
88"	87-6/16"	2.00	14.67	2.79	23.25	3.70	27.13	5.92	43.40
92"	91-5/16"	2.00	15.37	2.79	24.18	3.70	28.36	5.92	45.40
96"	95-4/16"	2.00	16.00	2.79	25.10	3.70	29.60	5.92	47.45
100"	99-3/16"	2.00	16.67	2.79	26.03	3.70	30.93	5.94	49.45
104"	103-2/16"	2.00	17.37	2.79	26.96	3.70	32.26	5.94	51.45
108"	107-1/16"	2.00	18.00	2.79	27.90	3.73	33.60	5.94	53.50
112"	111 "	2.00	18.67	2.79	28.85	3.73	34.93	5.99	55.30
116"	114-15/16"	2.00	19.37	2.79	29.80	3.73	36.26	5.99	57.10
120"	120-14/16"	2.00	20.00	2.79	30.75	3.76	37.60	5.99	58.90
124"	122-13/16"	2.00	20.67	2.79	31.70	3.76	38.80	5.85	60.70
128"	126-12/16"	2.00	21.34	2.79	32.65	3.76	40.00	5.85	62.50
132"	130-11/16"	2.00	22.00	2.79	33.60	3.74	41.20	5.85	64.30
136"	136-10/16"	2.00	22.67	2.79	34.55	3.74	42.40	5.82	66.10
140"	138-9/16"	2.00	23.34	2.79	35.50	3.74	43.60	5.82	67.90
144"	144-8/16"	2.00	24.00	2.80	36.45	3.73	44.80	5.82	69.68

Connectors & Accessories

Linking and extension cable options

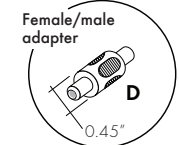
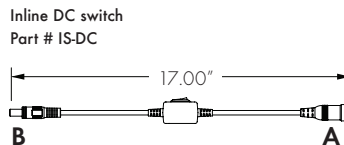
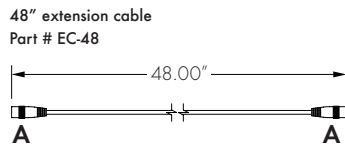
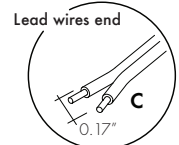
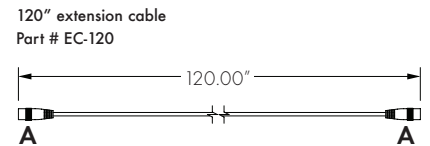
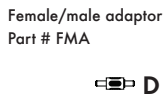
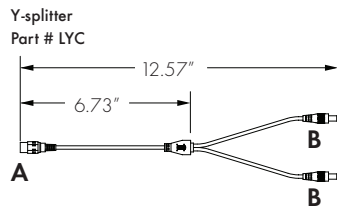
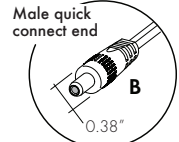
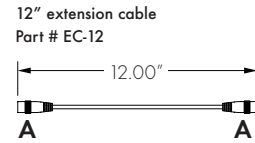
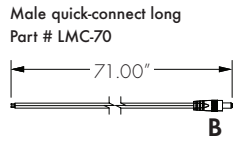
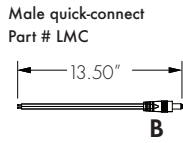
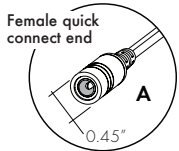

Powerfeed Position / Type

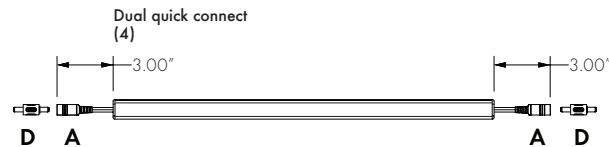
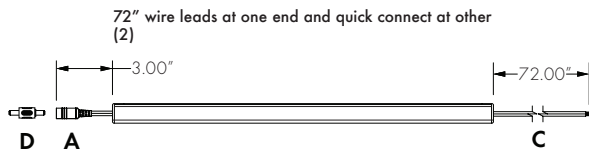
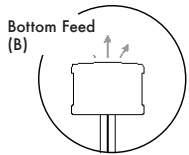
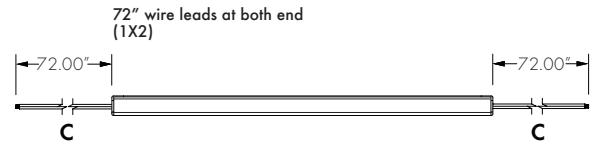
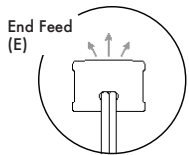

3, and 4 powerfeed options require #LMC to connect to PSD series of power supplies.

Accessory options

Splice Box:
Low voltage, 4 terminal splice box, black

Part # LVSP-4T-BK

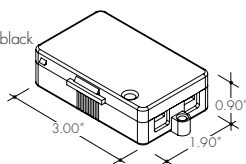

Sample layout

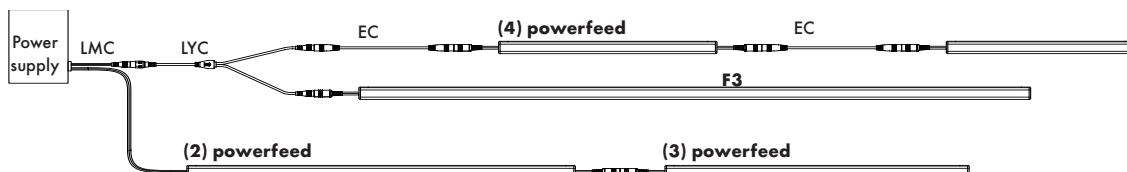

Power supply

See fixture and power supply instructions & spec sheet for wiring information. Dimming possible in select models - view Luminii website for list of compatible dimmers.

Magnetic Low Voltage Dimming Power Supplies:

MODEL	POWER	OUTPUT	INPUT
PSD	48	24	
PSD - PSD Series dims down to 0%	48 - 48 W 96 - 96 W 288 - 288 W (3x 96W)	24 - 24 VDC	Blank - 120 V 240 - 240 V 277 - 277 V

MODELS	PSD 48	PSD 96	PSD 288
A Length	11.25"	11.25"	13.06"
B Width	3.42"	3.42"	8.42"
C Depth	3.42"	3.27"	4.47"

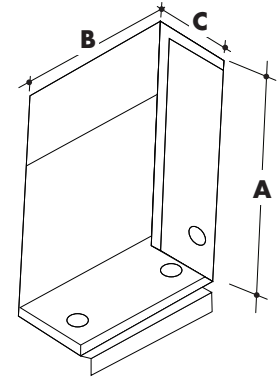

Electronic Low Voltage Dimming Power Supplies:

MODEL	CIRCUIT x POWER	OUTPUT	INPUT
CVE	48D	24	
CVE - CVE Series dims down to 0.1%	48D - 48W 48X2D - 2 x 48W 48X3D - 3 x 48W 48X4D - 4 x 48W 96D - 96W 96X2D - 2 x 96W 96X3D - 3 x 96W 96X4D - 4 x 96W	24 - 24 VDC	Blank - 120 V 277 - 240/277 V

MODELS	Single circuit	Dual circuit	Three circuit	Four circuit
A Length	13.9"	13.8"	13.8"	13.8"
B Width	2.3"	4.0"	5.9"	7.75"
C Depth	1.3"	1.9"	1.9"	1.9"

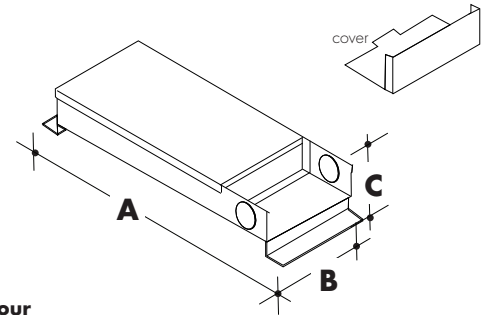

0-10V Dimming Power Supplies:

MODEL	POWER	OUTPUT	DIMMING
PSO10V	3X96	24	LIN
PSO10V - 0-10V Power Supply dims down to 0%	96 - 96 WATT 3X96 - 3 X 96 WATT	24 - 24 VDC	LIN - Linear LOG - Logarithmic

MODELS	96 W	3X96
A Length	14.40"	15.75"
B Width	5.20"	6.60"
C Depth	2.60"	4.80"

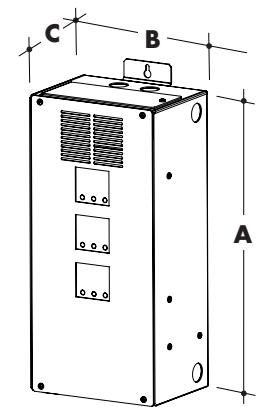

MODEL	POWER	OUTPUT	DIMMING	LOCATION
PSV	40	24V	U2DIM	D
PSV - PSV Series dims down to 5%	40 - 40 W 60 - 60 W 96 - 96 W	24 - 24 VDC	U2DIM - Dimming 0-10V	D - Dry Location IP65 - Wet Location

MODELS	PSV Dry	PSV Wet
A Length	9.2"	9.5"
B Width	3.4"	4.12"
C Depth	1.9"	2.3"

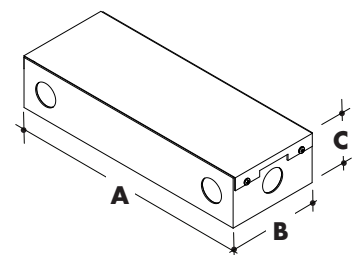

Power supply

See fixture and power supply instructions & spec sheet for wiring information. Dimming possible in select models - view Luminii website for list of compatible dimmers.

DMX Dimming Power Supplies:

MODEL	POWER	OUTPUT
PSDMX	96	24
PSDMX - DMX Power Supply	96 - 96 WATT 3X96 - 3 X 96 WATT	24 - 24 VDC

- Features eldoLED's LINEARdrive configurable dimmable drivers

MODELS	3X96 W
A Length	15.75"
B Width	6.60"
C Depth	4.80"

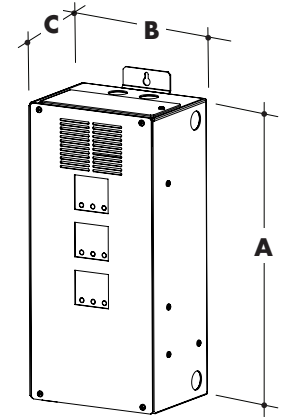

DALI Dimming Power Supplies:

MODEL	POWER	OUTPUT
PSDALI	96	24
PSDALI - DALI Power Supply dims down to 0%	96 - 96 WATT 3X96 - 3 X 96 WATT	24 - 24 VDC

- Features eldoLED's LINEARdrive configurable dimmable drivers

MODELS	96 W
A Length	14.40"
B Width	5.20"
C Depth	2.60"

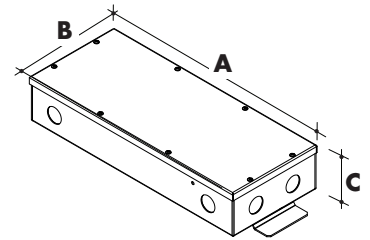

Luminii is a Lutron OEM Advantage Partner

MODEL		
LTEA4U1UKL-CV240		
Lutron -Hi-lume™ 1% 2-wire LED driver (120V forward phase only)		

MODELS	LTEA	L3DA
A Length	4.89"	4.89"
B Width	2.66"	2.66"
C Depth	4.00"	4.00"

MODEL		
L3DA4U1UKL-CV240		
Hi-lume™ 1% EcoSystem Voltage LED Driver		

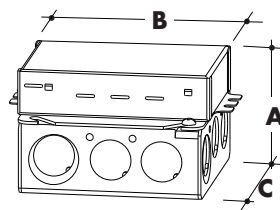

MODEL		
L3D0-96W24V-U		
Hi-lume™ 0.1% EcoSystem Voltage LED Driver with Soft-On, Fade-to-Black™		

MODELS	L3D0
A Length	10.50"
B Width	5.50"
C Depth	2.00"

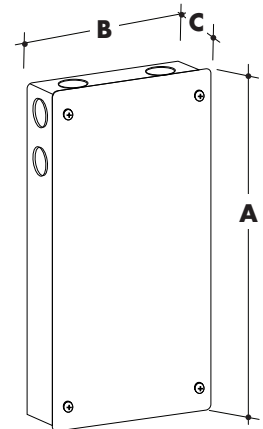

Power supply

See fixture and power supply instructions & spec sheet for wiring information. Dimming possible in select models - view Luminii website for list of compatible dimmers.

Enlighted Enabled Dimming Power Supplies:

MODEL	POWER	OUTPUT	DIMMING	Location
PSV	96	24	ENL	D
PSV - LED Power Supply	96 - 96 WATT	24 - 24 VDC	ENL - Enlighted Dimming	D - Damp

MODELS	96 W
A Length	14.40"
B Width	5.20"
C Depth	2.60"

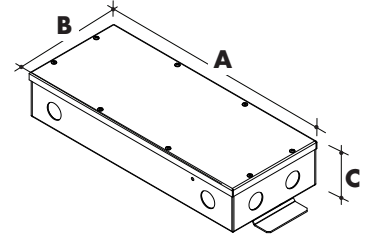

Non-Dimming Power Supplies:

MODEL	POWER	OUTPUT	DIMMING	LOCATION
PSV	40	24V	U2ND	D
PSV - PSV Series	40 - 40 W 60 - 60 W 96 - 96 W	24 - 24 VDC	U2ND - Non Dimming	D - Dry Location IP65 - Wet Location

MODELS	PSV Dry	PSV Wet
A Length	9.2"	9.5"
B Width	3.4"	4.12"
C Depth	1.9"	2.3"

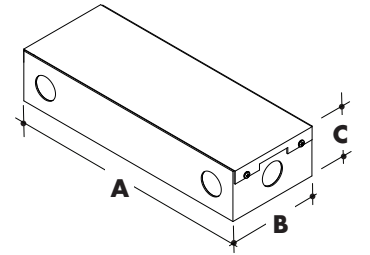

In ground, Electronic Low Voltage Dimming Power Supplies:

MODEL	CIRCUIT x POWER	OUTPUT	INPUT
IG-CVE	96X2	24	
IG-CVE - In ground CVE Series dims down to 0.1%	96X2 - 2 x 96W	24 - 24 VDC	Blank - 120 V 277 - 240/277 V

MODELS	Dual circuit
A Length	8.0"
B Width	8.0"
C Depth	8.0"

