

# MINIMO PRO

WITH DYNAMIC WHITE LIGHT ENGINE



Minimo Pro features the all-new Precision Dynamic White light engine: Precision Dynamic White offers specifiers tunable CCT ranges (1800-3000K and 2700-5000K) all through a color mixing TIR optic. This is a constant current downlight machined from aerospace grade aluminum 6063-T6 and comes with a range of standard and premium finishes. It has four tool-less site changeable optics for flexible beam distribution. Minimo Pro has up to 35° tilt whilst the integral accessory holder can accommodate a lens or louvre for additional glare control.

## KEY FEATURES

- Fixed or 35° adjustable tilt
- Tool-less site changeable optics
- High power COB light engine
- Beveled or Pinhole aesthetic
- Trimmed or Trimless

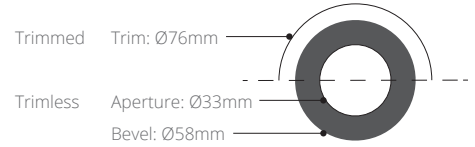

## PERFORMANCE DATA

<b>DELIVERED LUMENS</b>	900lm (at 3000K)	<b>WATTAGE</b>	12.6W
<b>BEAM ANGLES</b>	25°   32°   46°   56°	<b>ELECTRICAL</b>	36V   350mA
<b>CCT</b>	1800K - 3000K   2700K - 5000K	<b>DRIVER LOCATION</b>	Remote
<b>CRI</b>	92TYP	<b>REMOTE DRIVERS</b>	DALI DT6   DALI DT8   Casambi
<b>TM-30</b>	RF: 90 RG: 99 (at 3000K)	<b>ACCESSORIES</b>	Louwer   Lenses
<b>BINNING</b>	3 SDCM	<b>ACCESSORY HOLDER</b>	Integral
<b>LIFETIME</b>	L90 50,000 hrs min	<b>TM65</b>	13.09kgCO2e
<b>WARRANTY</b>	5 Years	<b>TM66</b>	2.2

## MECHANICAL & MOUNTING

<b>LOCATION</b>	IP20   IP54 available	<b>MOUNTING</b>	Recessed
<b>ADJUSTABILITY</b>	Fixed or 35° Tilt, 360° Rotation	<b>CEILING THICKNESS</b>	3-25mm
<b>OPTICS</b>	Site Changeable	<b>CUTOUT</b>	65mm
<b>WEIGHT</b>	250g	<b>MIN VOID HEIGHT</b>	130mm
<b>MATERIAL</b>	Machined AL 6063-T6		

## BEVELED APERTURE ORDER CODE

TRIM TYPE	FUNCTION	TRIM FINISH	APERTURE FINISH	CCT	BEAM ANGLE
RCD- Trimmed RCT- Trimless	FIXED 631C- IP20 633C- IP54	X Trimless W White RAL9010 B Black RAL9005 A Brushed Aluminium R Rubbed Bronze <sup>1</sup> P Polished Brass <sup>1</sup> S Brushed Brass <sup>1</sup> C Polished Chrome <sup>1</sup>	W- White RAL9010 B- Black RAL9005 G- Matt Gold Paint	T01 1800K-3000K T02 2700K-5000K	ME Medium 25°
					WD Wide 32° VW Very Wide 46° UW Ultra Wide 56°
	ADJUSTABLE 635C- IP20 637C- IP54				

## PINHOLE APERTURE ORDER CODE

TRIM TYPE	FUNCTION	TRIM FINISH	APERTURE FINISH	CCT	BEAM ANGLE
RCD- Trimmed RCT- Trimless	FIXED 632C- IP20 634C- IP54	X Trimless W White RAL9010 B Black RAL9005	W- White RAL9010 B- Black RAL9005	T01 1800K-3000K T02 2700K-5000K	ME Medium 25°
					WD Wide 32° VW Very Wide 46° UW Ultra Wide 56°
	ADJUSTABLE 636C- IP20 638C- IP54				

<sup>1</sup>: Premium & custom finishes are built to order, subject to an extended lead time.

Code example  
RCD-635C-BG-T01ME

## DRIVER ORDER CODE

<b>PSCC-63XT01DT6M-E1</b> DALI DT6 Dim 0.1% 1800-3000K	<b>PSCC-63XT01DT8M-E1</b> DALI DT8 Dim 0.1% 1800-3000K
<b>PSCC-63XT02DT6M-E1</b> DALI DT6 Dim 0.1% 2700-5000K	<b>PSCC-63XT02DT8M-E1</b> DALI DT8 Dim 0.1% 2700-5000K

Need a dimming protocol not listed here?  
Contact us for our extended range of driver options

TRIM & APERTURE TYPES



TRIMMED  
PINHOLE



TRIMLESS  
PINHOLE



TRIMMED  
BEVELED



TRIMLESS  
BEVELED

TRIM FINISHES

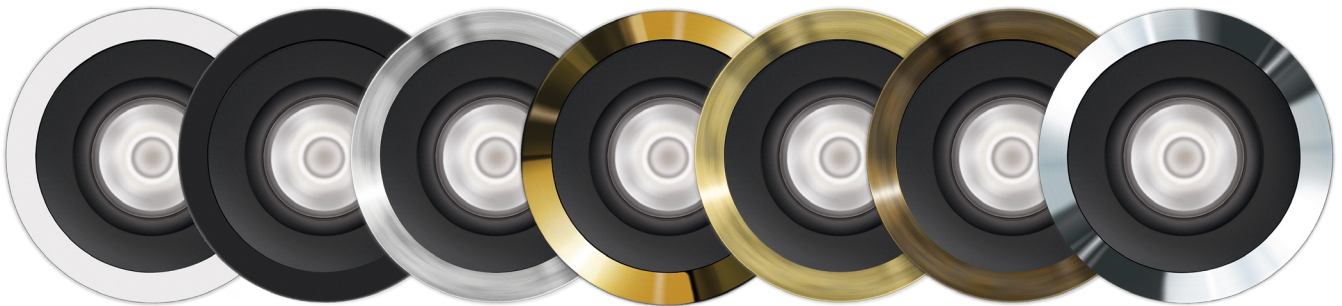

WHITE

BLACK

BRUSHED  
ALUMINUM

POLISHED  
BRASS

BRUSHED  
BRASS

RUBBED  
BRONZE

POLISHED  
CHROME

APERTURE FINISHES

BEVELED

PINHOLE

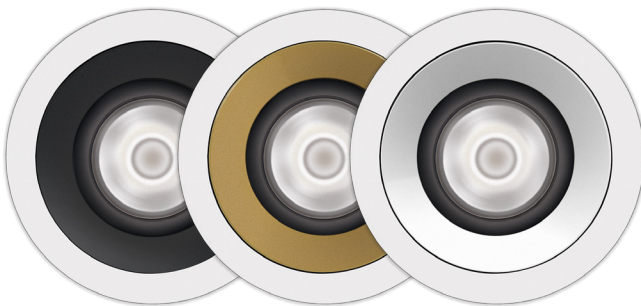

BLACK

MATTE GOLD

WHITE



WHITE



BLACK

MINIMO PRO

WITH DYNAMIC WHITE LIGHT ENGINE

DIMENSIONS

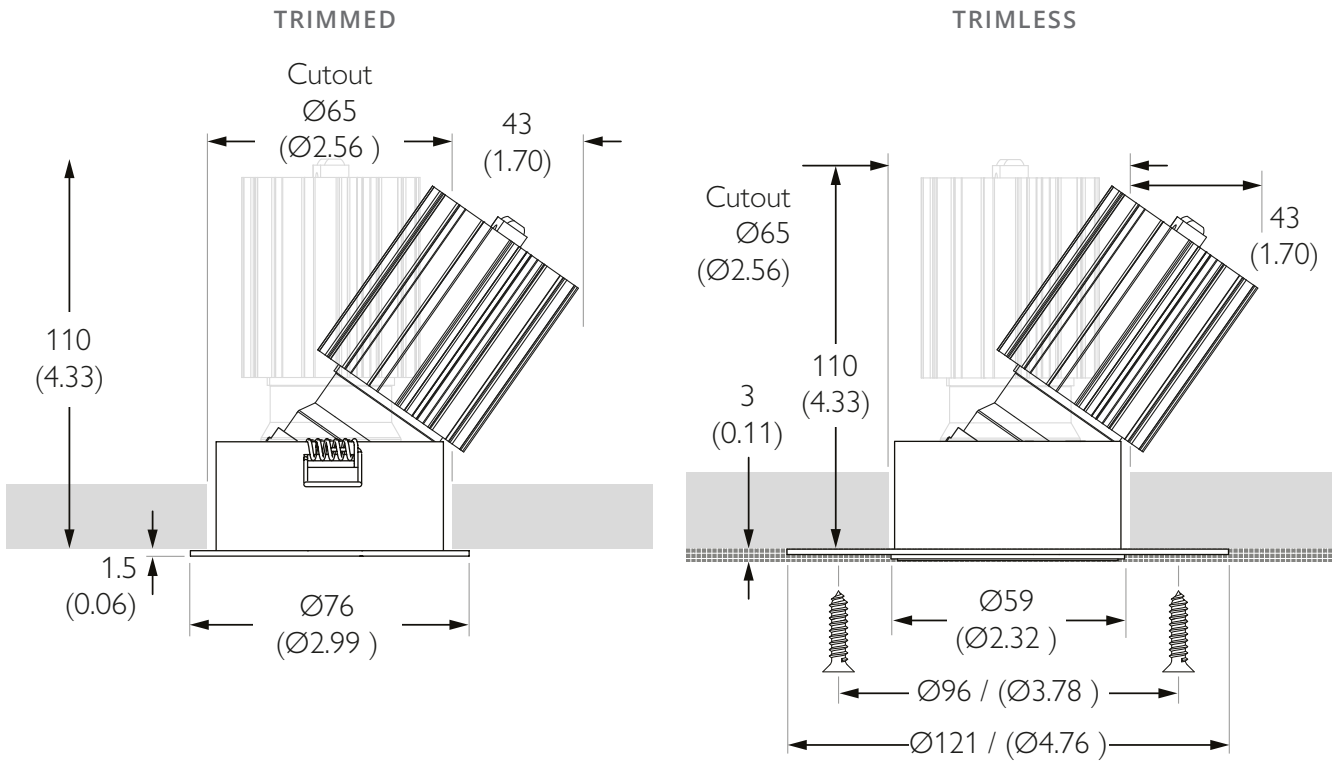

REMOTE DRIVER DETAIL

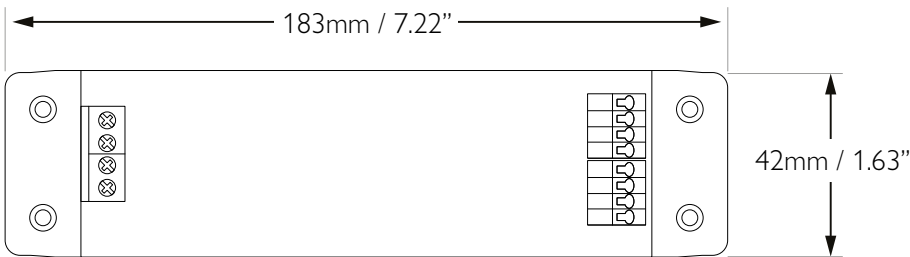

Dimming Type DALI  
 Min Dim Level 0.1%  
 Voltage In 230V  
 Manufacturer Eldoled

DT6  
 Code 1800-3000K PSCC-63XT01DT6M-E  
 Code 2700-5000K PSCC-63XT02DT6M-E

DT8  
 Code 1800-3000K PSCC-63XT01DT8M-E  
 Code 1800-3000K PSCC-63XT02DT8M-E

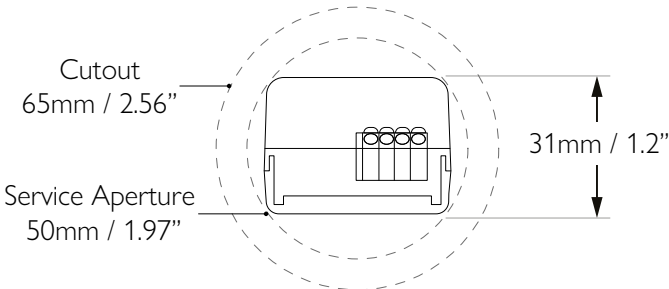

# MINIMO PRO

WITH DYNAMIC WHITE LIGHT ENGINE

## OUTPUT SCALING

CCT	Multiplier	CRI	R9	Rf	Rg	Max Delivered lm
1800K	0.57	92	68	90	99	514lm
2400K	0.77	92	80	90	99	695lm
<b>3000K</b>	<b>1.00</b>	<b>92</b>	<b>75</b>	<b>90</b>	<b>99</b>	<b>902lm</b>
4000K	1.05	91	70	89	99	947lm
5000K	1.06	91	65	89	99	956lm

All diagrams and data measured at 3000K.

## PHOTOMETRY

### MEDIUM BEAM

BEAM ANGLE 25°  
DELIVERED LUMENS 874lm  
UGR 14.3  
PEAK INTENSITY 3600cd

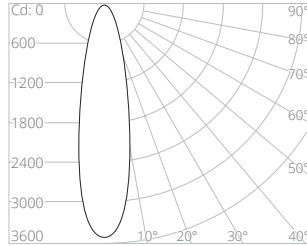
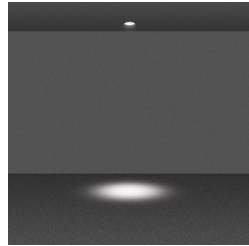

Height	Beam Diameter	Footcandle (lx)	Footcandle (fc)	Height (ft)	Height (ft)
1m	0.44m	3600lx	400fc	1.3ft	3ft
2m	0.89m	900lx	100fc	2.7ft	6ft
3m	1.33m	400lx	44fc	4.0ft	9ft
4m	1.77m	225lx	25fc	5.3ft	12ft
5m	2.22m	144lx	16fc	6.7ft	15ft
			11fc	8.0ft	18ft

### WIDE BEAM

BEAM ANGLE 32°  
DELIVERED LUMENS 902lm  
UGR 14.5  
PEAK INTENSITY 2930cd

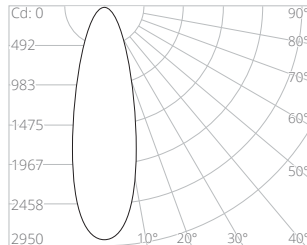
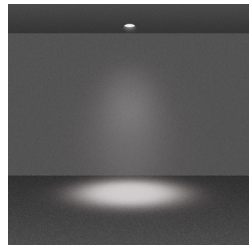

Height	Beam Diameter	Footcandle (lx)	Footcandle (fc)	Height (ft)	Height (ft)
1m	0.57m	2930lx	326fc	1.7ft	3ft
2m	1.15m	733lx	81fc	3.4ft	6ft
3m	1.72m	326lx	36fc	5.2ft	9ft
4m	2.29m	183lx	20fc	6.9ft	12ft
5m	2.87m	117lx	13fc	8.6ft	15ft
			9fc	10.3ft	18ft

### VERY WIDE BEAM

BEAM ANGLE 46°  
DELIVERED LUMENS 892lm  
UGR 16.0  
PEAK INTENSITY 1560cd

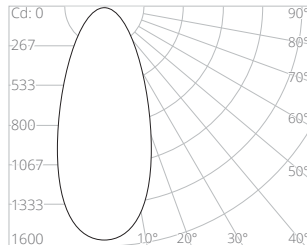
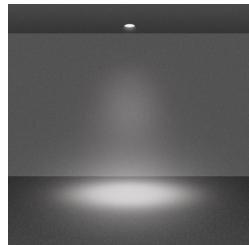

Height	Beam Diameter	Footcandle (lx)	Footcandle (fc)	Height (ft)	Height (ft)
1m	0.85m	1560lx	173fc	2.5ft	3ft
2m	1.70m	390lx	43fc	5.1ft	6ft
3m	2.55m	173lx	19fc	7.6ft	9ft
4m	3.40m	98lx	11fc	10.2ft	12ft
5m	4.24m	62lx	7fc	12.7ft	15ft
			5fc	15.3ft	18ft

### ULTRA WIDE BEAM

BEAM ANGLE 56°  
DELIVERED LUMENS 877lm  
UGR 19.9  
PEAK INTENSITY 1080cd

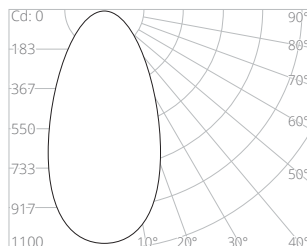
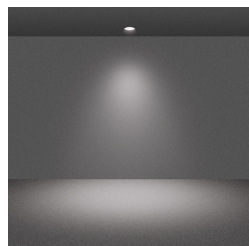

Height	Beam Diameter	Footcandle (lx)	Footcandle (fc)	Height (ft)	Height (ft)
1m	1.06m	1080lx	120fc	3.2ft	3ft
2m	2.13m	270lx	30fc	6.4ft	6ft
3m	3.19m	120lx	13fc	9.6ft	9ft
4m	4.25m	68lx	8fc	12.8ft	12ft
5m	5.32m	43lx	5fc	16.0ft	15ft
			3fc	19.1ft	18ft



# MINIMO PRO

WITH DYNAMIC WHITE LIGHT ENGINE

## ACCESSORIES

The Minimo Pro can accommodate 1 accessory with no additional holder required as standard.

### Honeycomb Louver

*Enhances glare control*

THICKNESS 3.2mm

DAIMETER 32mm

PART CODE 995-32-BK

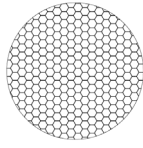

### 1/4 CTO Dichroic

*CCT warming - approx 300K*

THICKNESS 1.8mm

DAIMETER 32mm

PART CODE 997-1/4CTO-32



## LUMINAIRE MODULE DETAILS

