

Features

Kurba Vertical Dynamic White is a direct view, small profile, energy efficient and flexible LED strip suitable for wet locations capable of vertical/top bends up to 6" radius. Built with robust factory made power feeds or joiners, Kurba Vertical Dynamic White mounts to a specifically designed aluminum extruded channel.

Applications

Outdoor wet location

Operating Voltage

24VDC

Operating Temperature

-4°F to 113°F (-20°C to 45°C)

Average Life

50,000 hours

Approvals

Class 2 wet listed, IP67

Warranty

3 years



Warm Dimming Dynamic White Wet Rated IP67

Technical Information

Model	KBL-F-V-DW19K27K		
LEDs/ft	44		
Light Output	19K:	27K:	All On:
	55 lm/ft	55 lm/ft	110 lm/ft
Average Power Consumption at 4'	3.65 W/ft		
Ordering Increment	3.28"		
Maximum Run Length (In Series)	26'		

Constraints

Bend Direction

Bend LED in these positions only to avoid damage

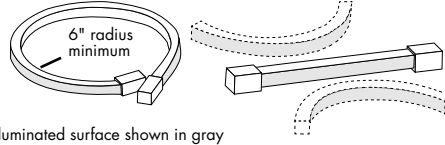

Illuminated surface shown in gray

Prohibited Bends

Twisting or bending LED in these positions will cause damage

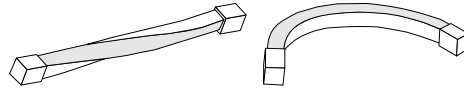

Illuminated surface shown in gray

Note: for horizontal bends refer to Luminii KBM series
Do not make sharp bends near the endcap

Power Feed Locations

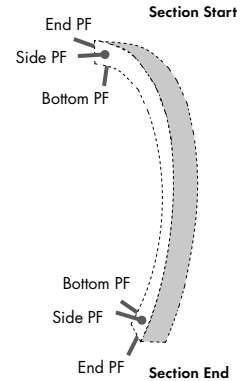

Section Start/End Power Feed Options

Injection Molded End Cap (IEC)

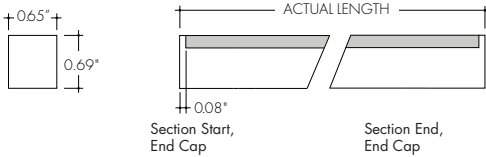

Injection Molded Bottom Power Feed (IBPF)

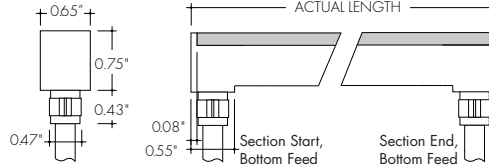

Injection Molded End Power Feed (IEPF)

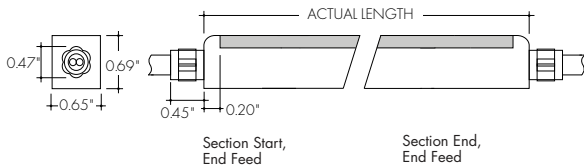

Injection Molded Side Power Feed (ISPF)

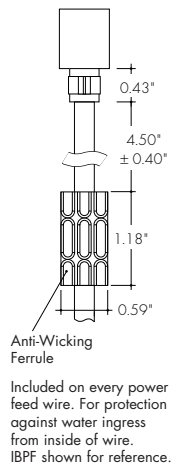
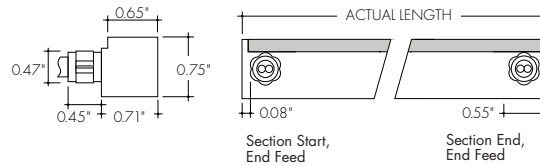

Ordering Code

MODEL	COLOR	SECTION START	SECTION END	ACTUAL LENGTH
KBL-F-V-Kurba Large, flat vertical	DW-Dynamic White 1900K-2700K	IEC-Injection Molded End Cap ¹ IEPF-Injection Molded End Power Feed (9' wire lead) ¹ IBPF-Injection Molded Bottom Power Feed (9' wire lead) ¹ ISPF-Side Power Feed (9' wire lead) ^{1,2}	IEC-Injection Molded End Cap ¹ IEPF-Injection Molded End Power Feed (9' wire lead) ¹ IBPF-Injection Molded Bottom Power Feed (9' wire lead) ¹ ISPF-Side Power Feed (9' wire lead) ^{1,2}	See Power Consumption table on page 4 for available lengths

1 - 6-8 weeks lead time. Kurba injected-molded orders are non-cancellable. IEPF, IBPF, ISPF cannot be mixed and matched from Start to End except with IEC.
2 - ISPF Side power feeds selected for both Section Start and End will be located on the same side of the strip.

Mounting Accessories & Optional Connectors

MC-NFS-KBL-F-V-78

Mounting Channel with Grip, 78"

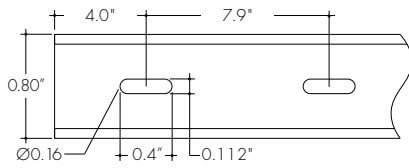
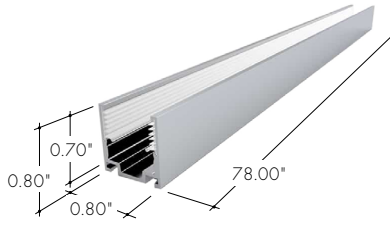

Aluminum mounting channel providing grip. For use with light strip mounted to the ceiling.

MB-KBL-F-V-ST

Mounting Bracket with Grip

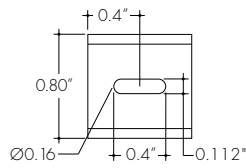
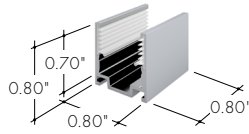

Aluminum mounting bracket providing grip. For use with light strip mounted to the ceiling. 1 recommended every 8 in.

MC-FS-KBL-F-V-78

Flanged Mounting Channel with grip, 78"

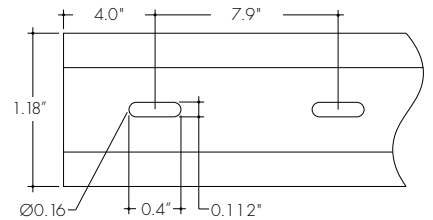
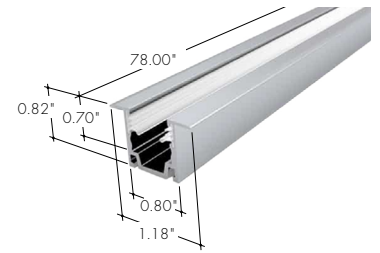

Flanged aluminum mounting channel providing grip. For use with light strip mounted to the ceiling.

MC-BNS-KBL-F-V-34

Bendable Mounting Channel with grip, 34"

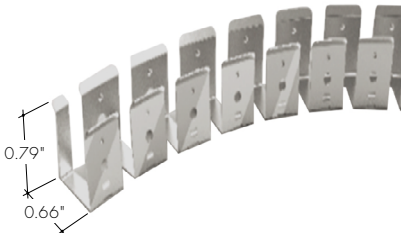

Bendable stainless steel mounting channel providing grip. For use with light strip mounted to the ceiling.

LVSP-WET-CM

Connector

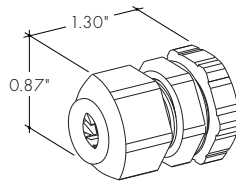

Low voltage splice box wet cable management, gray.

LVSP-WET

Splice Box

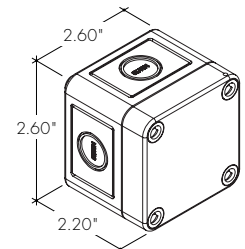

Wet rated, low voltage splice box, gray.

Power Consumption Per Fixture Length

Based on operation with PSD series of power supplies. Use Actual Length for Order Code Entry
 Tolerance for Actual Lengths less than 6 ft is +/- 0.2", Actual Lengths between 6 ft and 16 ft is +/- 0.3", and Actual Lengths greater than 16 ft is +/- 0.6"

KBL-F-V-DW19K27K

Nominal Length [inches]	Actual Length [inches]				Nominal Length [inches]	Actual Length [inches]				Nominal Length [inches]	Actual Length [inches]			
	W	IEPF IEPF	IEPF IEC	IEC IBPF ISPF		W	IEPF IEPF	IEPF IEC	IEC IBPF ISPF		W	IEPF IEPF	IEPF IEC	IEC IBPF ISPF
4	-	-	-	-	112	34.1	111.9	111.8	111.7	220	67.1	220.2	220.1	220
7	2.1	7	6.8	6.7	115	35.1	115.2	115.1	115	223	68.1	223.5	223.4	223.2
10	3.1	10.2	10.1	10	(10 ft) 118	36.1	118.5	118.4	118.3	(19 ft) 227	69.1	226.8	226.6	226.5
(1 ft) 14	4.1	13.5	13.4	13.3	122	37.1	121.8	121.7	121.5	230	70.1	230	229.9	229.8
17	5.1	16.8	16.7	16.6	125	38.1	125.1	124.9	124.8	233	71.1	233.3	233.2	233.1
20	6.1	20.1	20	19.8	128	39.1	128.3	128.2	128.1	237	72.1	236.6	236.5	236.4
(2 ft) 23	7.1	23.4	23.2	23.1	(11 ft) 132	40.1	131.6	131.5	131.4	(20 ft) 240	73.1	239.9	239.8	239.7
27	8.1	26.6	26.5	26.4	135	41.1	134.9	134.8	134.7	243	74.1	243.2	243.1	242.9
30	9.1	29.9	29.8	29.7	138	42.1	138.2	138.1	137.9	246	75.1	246.5	246.3	246.2
33	10.1	33.2	33.1	33	141	43.1	141.5	141.4	141.2	250	76.1	249.7	249.6	249.5
(3 ft) 36	11.1	36.5	36.4	36.2	(12 ft) 145	44.1	144.8	144.6	144.5	(21 ft) 253	77.1	253	252.9	252.8
40	12.1	39.8	39.6	39.5	148	45.1	148	147.9	147.8	256	78.1	256.3	256.2	256.1
43	13.1	43	42.9	42.8	151	46.1	151.3	151.2	151.1	260	79.1	259.6	259.5	259.3
46	14.1	46.3	46.2	46.1	(13 ft) 155	47.1	154.6	154.5	154.4	(22 ft) 263	80.1	262.9	262.7	262.6
(4 ft) 50	15.1	49.6	49.5	49.4	158	48.1	157.9	157.8	157.6	266	81.1	266.1	266	265.9
53	16.1	52.9	52.8	52.7	161	49.1	161.2	161	160.9	269	82.1	269.4	269.3	269.2
56	17.1	56.2	56.1	55.9	164	50.1	164.4	164.3	164.2	273	83.1	272.7	272.6	272.5
(5 ft) 59	18.1	59.5	59.3	59.2	(14 ft) 168	51.1	167.7	167.6	167.5	(23 ft) 276	84.1	276	275.9	275.7
63	19.1	62.7	62.6	62.5	171	52.1	171	170.9	170.8	279	85.1	279.3	279.1	279
66	20.1	66	65.9	65.8	174	53.1	174.3	174.2	174	282	86.1	282.5	282.4	282.3
69	21.1	69.3	69.2	69.1	178	54.1	177.6	177.4	177.3	286	87.1	285.8	285.7	285.6
(6 ft) 73	22.1	72.6	72.5	72.3	(15 ft) 181	55.1	180.8	180.7	180.6	(24 ft) 289	88.1	289.1	289	288.9
76	23.1	75.9	75.7	75.6	184	56.1	184.1	184	183.9	292	89.1	292.4	292.3	292.1
79	24.1	79.1	79	78.9	187	57.1	187.4	187.3	187.2	296	90.1	295.7	295.5	295.4
(7 ft) 82	25.1	82.4	82.3	82.2	(16 ft) 191	58.1	190.7	190.6	190.4	(25 ft) 299	91.1	298.9	298.8	298.7
86	26.1	85.7	85.6	85.5	194	59.1	194	193.8	193.7	302	92.1	302.2	302.1	302
89	27.1	89	88.9	88.7	197	60.1	197.2	197.1	197	305	93.1	305.5	305.4	305.3
92	28.1	92.3	92.1	92	200	61.1	200.5	200.4	200.3	309	94.1	308.8	308.7	308.5
(8 ft) 96	29.1	95.5	95.4	95.3	(17 ft) 204	62.1	203.8	203.7	203.6	(26 ft) 312	95.1	312.1	311.9	311.8
99	30.1	98.8	98.7	98.6	207	63.1	207.1	207	206.8					
102	31.1	102.1	102	101.9	210	64.1	210.4	210.2	210.1					
105	32.1	105.4	105.3	105.1	214	65.1	213.6	213.5	213.4					
(9 ft) 109	33.1	108.7	108.5	108.4	(18 ft) 217	66.1	216.9	216.8	216.7					

Note: all values are rounded to the nearest 0.1 inch

Injection Molded End Cap (IEC)

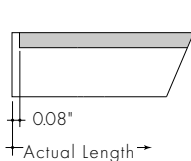

Injection Molded Bottom Power Feed (IBPF)

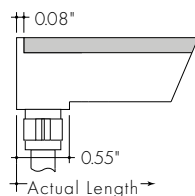

Injection Molded Side Power Feed (ISPF)

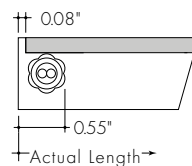

Injection Molded End Power Feed (IEPF)

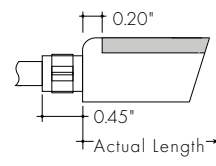

Power Supplies

See fixture and power supply instructions & spec sheet for wiring information. Dimming possible in select models - view Luminii website for list of compatible dimmers.

Triac, MLV, ELV, & PWM Compatible Dimmers

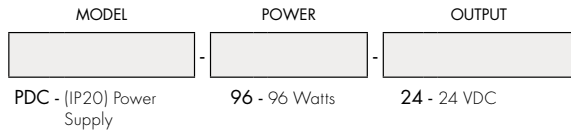

MODELS	96W
Length	8.25"
Width	4.10"
Depth	1.56"

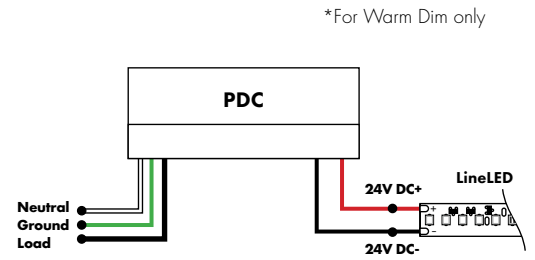

DALI 0% Dimming Power Supplies 120VAC - 277VAC

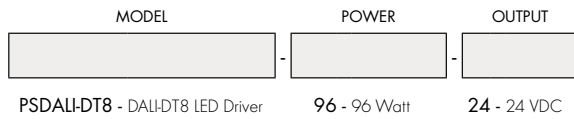

Features eldoLED's LINEARdrive configurable dimmable drivers

Model	96W
Length	14.40"
Width	5.20"
Depth	2.60"

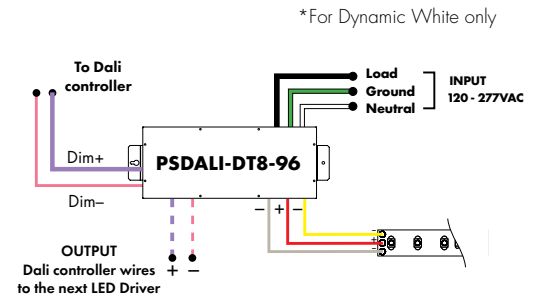

Customizable Dim to Warm or Variable White via 0 - 10V (for tunable white or warm dimming control of Dynamic option)

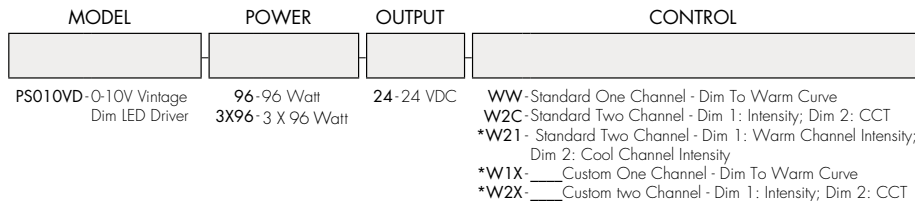

MODELS	96W	3X96
Length	14.40"	15.00"
Width	5.20"	6.61"
Depth	2.60"	4.56"

Requires a 0-10V controller to work properly
*For 96 only, not an option for 3X96.

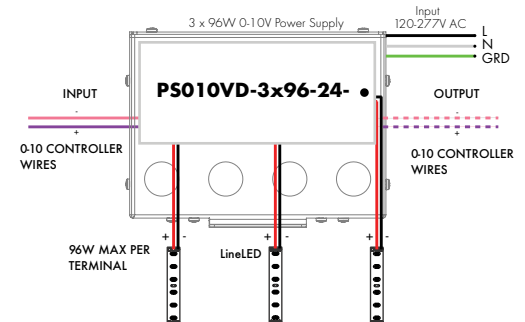
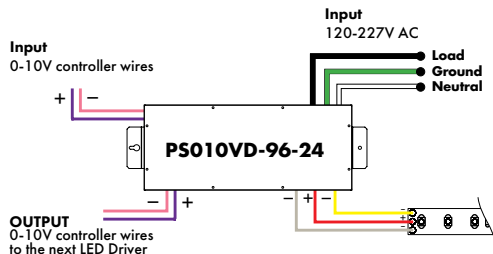

Power Supplies

See fixture and power supply instructions & spec sheet for wiring information. Dimming possible in select models - view Luminii website for list of compatible dimmers.

DMX Dimming Power Supplies 120VAC - 277VAC

*For RGB and RGBW only

MODEL	POWER	OUTPUT
PSDMX - DMX Power Supply dims down to 0%	96 - 96 Watt 3X96 - 3 X 96 Watt	24 - 24 VDC

MODELS	96W	3X96
Length	14.40"	15.75"
Width	5.20"	6.62"
Depth	2.60"	4.95"

Features eldoLED's LINEARdrive configurable dimmable drivers

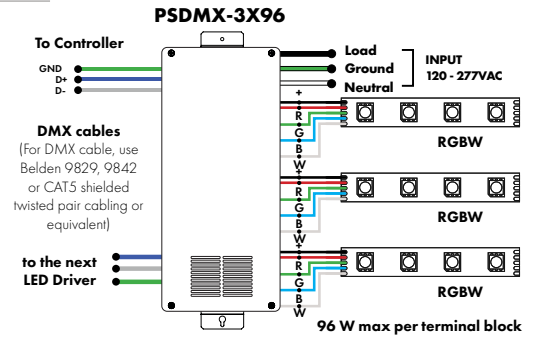
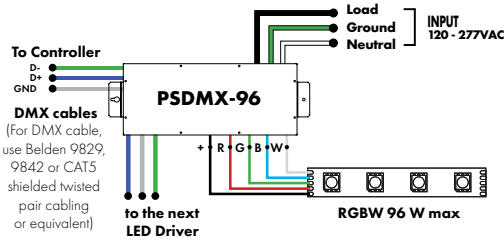

Non-Dimming Power Supply 120VAC - 277VAC

*For Dynamic White, RGB, RGBW and Pixel

*With controller only

MODEL	POWER	OUTPUT	DIMMING	LOCATION
PSV - PSV Series	96 - 96 Watt	24 - 24 VDC	U2ND - Non Dimming	D - Dry location

Requires a controller and a decoder to work properly

MODELS	96W
A Length	14.40"
B Width	5.20"
Depth	2.60"

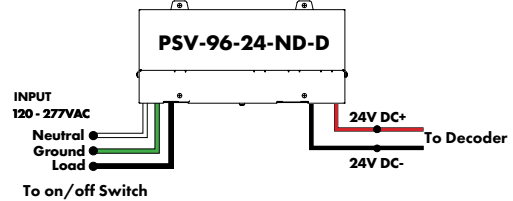

DMX Decoder

DMX signal to RGBW decoder (required to operate DMX controller)



Translates controller DMX512 programs for RGB and white LED strips.

Unique DMX address for the decoder can be set easily and displayed by the numeric display on the case. Changing and resetting the DMX address requires manual input.

Use power repeater to expand output.

Operating Voltage

12-36 VDC

Power Capacity

up to 96W at 24V

Operating Temperature Range

from -4°F to +122°F in case

ORDERING CODE

MODEL

DDMX-RGBW

DDMX-RGBW - DMX decoder

Touch DMX Controller

Touchscreen digital LED controller



MODEL

TSDMX-E

TSDMX-E - Touchscreen DMX controller

Programmable advanced DMX512 lighting controller featuring a touch-screen interface. Operates as stand alone controller or integrated with most architectural lighting control systems. Can controller endless DMX512 enabled devices.

Mounts to standard single or dual gang wall box with the included power supply inside the junction box. Terminal block design for power and data connections.

Features

- Sleek glass design which sits 0.43" from the wall
- Graphical color display to show selected environment
- Color/dimmer/speed palette
- Color temperature mixing
- Touch sensitive buttons. No mechanical parts
- Touch sensitive wheel allows for accurate color selection
- Multi-zone microSD memory
- Multi-room control with 500 scenes, 10 zones
- 1024 DMX channels. Control 340 RGB fixtures
- USB & Ethernet connectivity for programming and control

Power Supply

7 VDC (included)

Programmability

PC, Mac, Tablet, Smartphone

Output Signal

DMX512 (1024 channels)

Color Parameters

- Brightness
- Saturation
- Speed of color changing sequence
- Fading / dimming / brightness

DMX-1Z-RGBW, DMX-3Z-RGBW

RGBW LED 1 or 3 Zone Controller



MODEL

ZONES

COLOR



DMX-DMX Controller 3Z-Three Zone RGBW-RGBW
1Z-One Zone

DMX /Wireless RGB-W wall-mount controller controls DMX lighting fixtures, wireless control of RGB-W lighting fixture or use both simultaneously. Fits in any standard US switch box. Includes all the outputs in the back of the controller.

Control brightness levels with a single touch, personalize and memorize 3 different scenes, and even create 3 variations of white.

Features

- 2 in 1 in-Wall Controller: DMX Control or Wireless RGB-W
- 65,000 Color Options, Dimming and Speed Control
- Memory Function
- 50 Foot Wireless Range
- Easily Fits Standard US Switch Boxes
- Touch Sensitive Glass Surface
- Includes 10 Built in Programs, or Create and Play Your Own

Operating Voltage

12 - 24V DC

Color Parameters

- Brightness
- Saturation
- Primary colors
- Fading
- Color changing speed

Smart Pixel Decoder

SPI signal to DMX signal decoder



Model

SR-DMX-SPI

SR-DMX-SPI - Smart Pixel Decoder

The SR-DMX-SPI is a smart LED pixel decoder that controls RGB/RGBW pixel LED strips with SPI signal. Designed with an OLED backlit panel, the pixel controller allows for easy configuration of most settings. Four push buttons are available for control of the LED functions.

*For pixel only.

Features

- 2 in 1 in-Wall Controller: DMX Control or Wireless RGB-W
- SPI signal output for RGB/RGBW pixel light control
- DMX512 controllable and RF/WIFI remote controllable
- Capable of addressing up to 1020 RGB pixels & 765 RGB pixels
- OLED panel allows for easy configuration

Operating Voltage

12 - 36V DC

Power capacity

up to 96W at 24V

Operating temperature range

from -4°F to +122°F in case