

Features

- 24VDC Class 2 fixtures made to order up to 144". Fixtures can be linked up to 48' depending on output
- Suitable for undercabinet, millwork, surface mount, direct view, cove, and accent light applications
- Approved for closet/storage space installation per NEC 410.16(A) (3) and 410.16(C)(5)
- Class 2 listed for damp locations
- Dot free even illumination with frosted lens
- High Color Quality options offer premium quality and vibrant colors with R9 values up to 97
- High Efficacy options offer best in class output and efficacy with over 880 lm/ft and up to 110 lm/W
- Proprietary strong bond solder method handles up to 50 lbs of pull force on wire leads and connectors
- 5 Year warranty

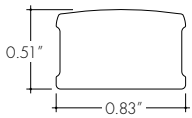

Finish Options (see page 2 for additional information)

- | | | |
|--|--------------------------------------|--|
| <input type="checkbox"/> Silver Anodized | <input type="checkbox"/> White | <input type="checkbox"/> Aged Brass |
| <input type="checkbox"/> Black | <input type="checkbox"/> Matte Black | <input type="checkbox"/> Polished Gold |
| <input type="checkbox"/> Bronze | <input type="checkbox"/> Warm Nickel | <input type="checkbox"/> Chrome |



Technical Information

MODEL	High Color Quality		High Efficacy				High Efficacy	
	60X2HO	60X2VHO	HE48LO	HE48SO	HE48MO	HE48HO	HE64VHO	HE64XHO
OUTPUT OPTIONS								
Lumens Output (3000K) <small>(with a Clear Lens)</small>	526 lm/ft	657 lm/ft	209 lm/ft	289 lm/ft	386 lm/ft	619 lm/ft	783 lm/ft	881 lm/ft
Average Power Consumption <small>(for a 4" section)</small>	7.3 W/ft	9.4 W/ft	1.9 W/ft	2.8 W/ft	3.5 W/ft	6.5 W/ft	7.5 W/ft	9.6 W/ft
Efficacy	72 lm/W	70 lm/W	110 lm/W	103 lm/W	110 lm/W	95 lm/W	104 lm/W	92 lm/W
Max Run Length <small>(in series)</small>	26 ft	21 ft	48 ft	42 ft	33 ft	21 ft	15 ft	13 ft
Max Ambient Temperature*	50°C [122°F]	40°C [111°F]	50°C [122°F]				45°C [118°F]	35°C [102°F]

*Max Ambient Temperature to maintain L70 of 50k+ hours. Exceeding Max Ambient Temperature may result in decreased life/output. Consult Technical Support for specific inquiries.

High Color Quality (72)

CCT	Multiplier <small>(reference - 3000K)</small>	CRI	TM-30		
			R _f	R _g	R ₉
1900K	0.55	96	94	97	90
2200K	0.70	96	95	101	89
2400K	0.72	98	97	101	91
2700K	0.74	97	96	101	91
3000K	1.00	97	95	104	97
3500K	1.02	97	94	105	97
4100K	1.07	97	90	99	97

High Efficacy (HE48/HE64)

CCT	Multiplier <small>(reference - 3000K)</small>	CRI	TM-30		
			R _f	R _g	R ₉
2200K	0.73	92	91	97	42
2500K	0.81	93	96	96	62
2700K	0.94	92	90	99	58
3000K	1.00	92	89	99	57
3500K	1.02	92	89	99	60
4000K	1.02	92	86	94	71

Ordering Code

MODEL	LENGTH ¹	OUTPUT	CCT	LENS ²	MOUNTING	FINISH ³	POSITION TYPE	POWER FEED
KXL-Kendo XL	12" - 144" 2" increments	60X2HO - High 60X2VHO - Very High	19K-1900K 22K-2200K 24K-2400K 27K-2700K 30K-3000K 35K-3500K 41K-4100K	C-Clear Lens HF-Half-Frosted F-Frosted	FC-Fixed Clip A-Adjustable Hinge Mounting FC45-Fixed Clip, 45° MAG-Magnetic	SA-Silver Anodized BK-Black BZ-Bronze WH-White MBK-Matte Black VWN-Warm Nickel AB-Aged Brass PG-Polished Gold ⁴ CH-Chrome ⁴	E-End B-Back S-Side	1-72" wire leads 1X2-72" wire leads at both ends 2-72" wire leads at one end and Quick Connect at other 3-Single Quick Connect 4-Dual Quick Connect
		HE48LO - Low HE48SO - Standard HE48MO - Medium HE48HO - High HE64VHO - Very High HE64XHO - Max	22K-2200K 25K-2500K 27K-2700K 30K-3000K 35K-3500K 40K-4000K					

1 - Custom lengths and increments are available, please consult Inside Sales with specific request.
2 - All High Efficacy options can be used to comply with Title 24 JAB. High Color Quality options can be used to comply with Title 24 JAB depending on Output, CCT, and Lens selections. See multiplier charts to calculate specific efficacies.

3 - Non SA finishes may have extended lead times. Custom RALs are available, please consult Inside Sales with specific request.
4 - Polished Gold finishes have a maximum fixture length of 48", and Chrome finishes have a maximum fixture length of 72".

Product Dimensions

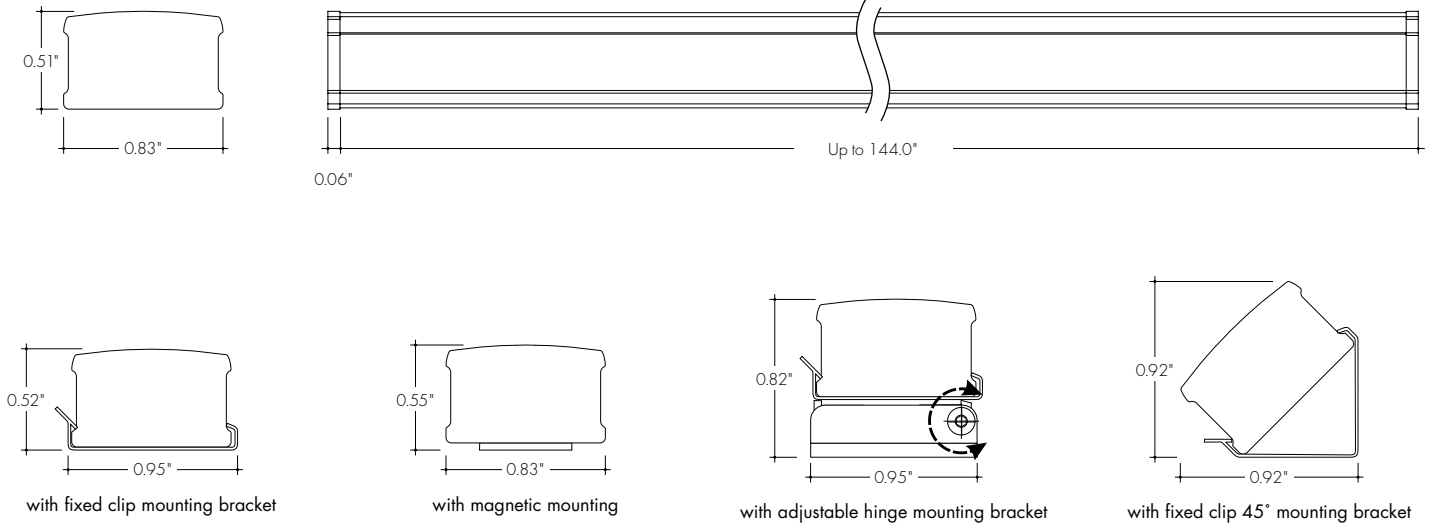

Finish Options

- Finish options are available in a wide variety, allowing for complete customization of style and aesthetic.
- Non Silver Anodized finishes may have extended lead times.
- Polished Gold finishes have a maximum fixture length of 48", and Chrome finishes have a maximum fixture length of 72".
- Custom RALs are available, please consult Inside Sales with specific request.

Silver Anodized



Silver Anodized is a soft silver with a clear finish.

Black



Black is a true deep black with a glossy finish.

Bronze



Bronze is a rich, dark brown with a satin finish.

White



White is a polar bright white and field paintable.

Matte Black

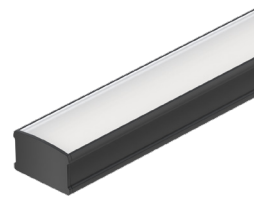

Matte Black is a dark, pitch-black with a soft flat finish.

Warm Nickel

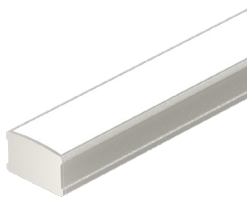

Warm Nickel is a soft, silvery smoke with warm tones and a satin finish.

Aged Brass

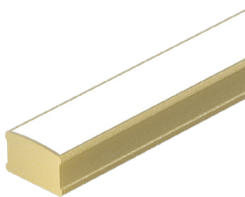

Aged Brass is a deep brown shade with slightly golden undertones.

Polished Gold

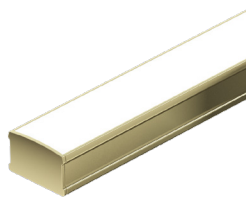

Polished Gold is bright and radiant for a brilliant finish.

Chrome



Chrome is a highly reflective silver polish.

Powerfeeds and Connectors

Linking and Extension Cable Options

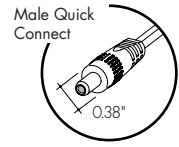

LMC-12
Male quick-connect, 2 pin, 12"

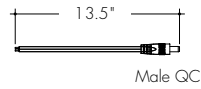

LMC-70
Male quick-connect long, 2 pin, 70"

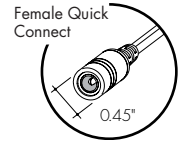
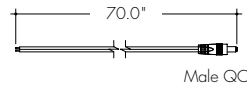

EC-12
Female to Female Extension Cable, 2 pin, 12"

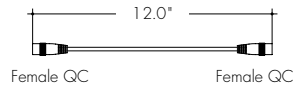

EC-48
Female to Female Extension Cable, 2 pin, 48"

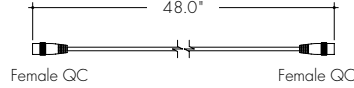

EC-120
Female to Female Extension Cable, 2 pin, 120"

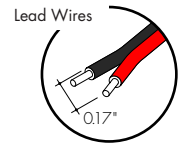
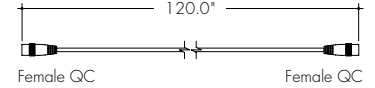

LYC
1 Female to 2 Male Splitter Cable, 2 pin, 12"

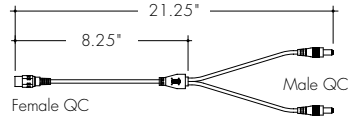

FMA
Female to male adapter

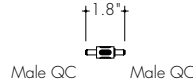

IS-DC
Male to Female Inline DC Switch, 2 pin, 12"

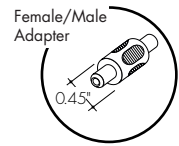
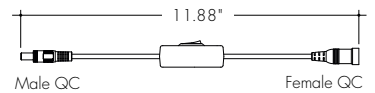

Powerfeeds Position/Type

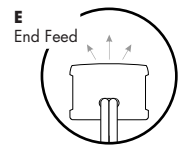

1
72" wire leads

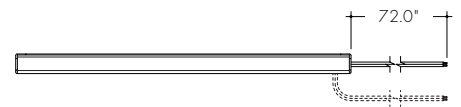

1X2
72" wire leads at both ends

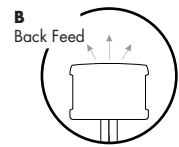

2
72" wire leads at one end and Female Quick Connect at other



3
Single Female Quick Connect

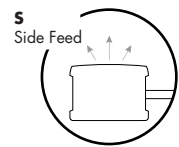
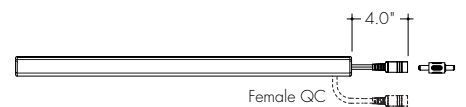

4
Dual Female Quick Connect



Side and Back feeds shown as dashed lines
All wires are 18 AWG unless otherwise specified

Sample Layout

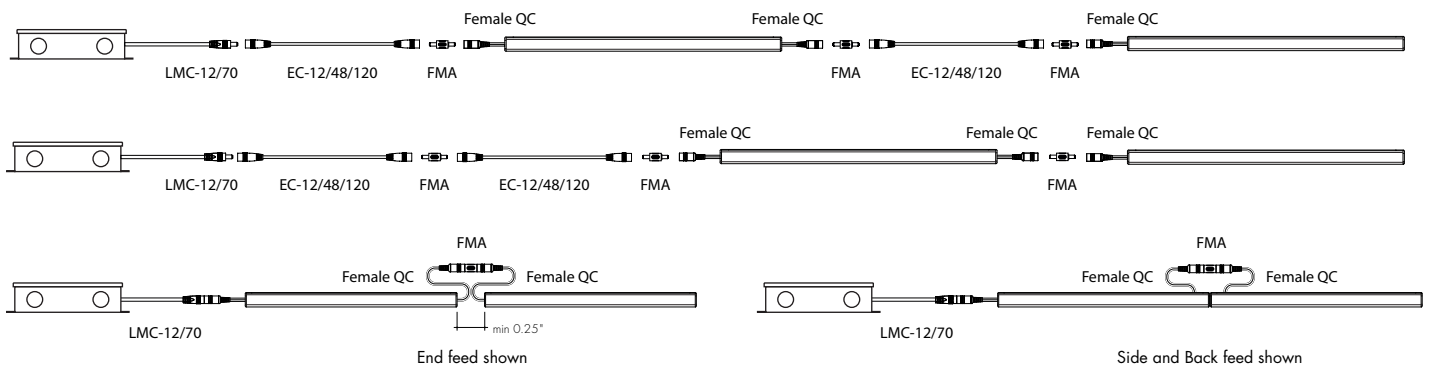

Light Transmission and Dotting

Output Options	Lens/Accessory		
	Clear Lens	Half-Frosted Lens	Frosted Lens
60X2HO	CD	SD	ND
60X2VHO	CD	SD	ND
HE48LO	CD	CD	ND
HE48SO	CD	CD	ND
HE48MO	CD	CD	ND
HE48HO	CD	CD	ND
HE64VHO	CD	CD	ND
HE64XHO	CD	CD	ND
Transmission Percentage	100%	84%	62%

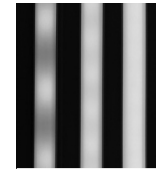

CD - Clear Dotting
SD - Slight Dotting
ND - No Dotting

Accessory Options

LVSP-4T-BK
 Low Voltage, 4 Terminal Splice Box, Black

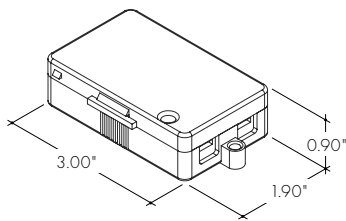

OS-DC-F4-BK
 Occupancy Sensor

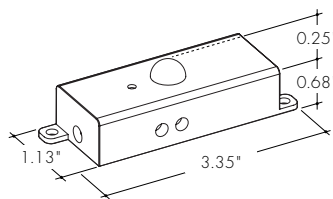

Male Quick Connect, FMA, LMC, LYC, or IS-DC are required for input and output.

DIM-DC-F4-BK
 24VDC Low Voltage In-line Dimmer Module

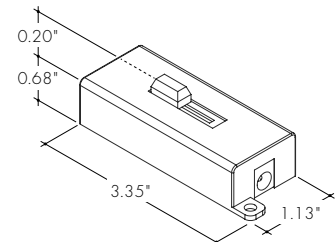

Male Quick Connect, FMA, LMC, LYC, or IS-DC are required for input and output.

Photometry

KXL-48-60X2VHO-30K-HF
Kendo XL, 4ft, 3000K, VHO, Half Frosted Lens

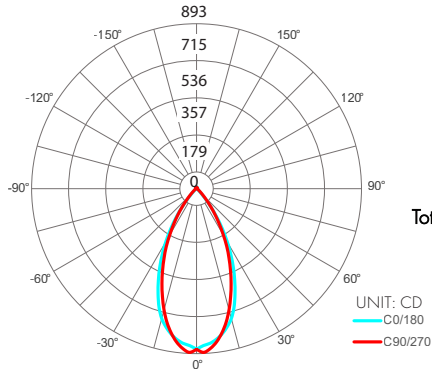

Zonal Lumen Summary 3000K

Zone	Lumen	% Fixture	
0-30	628	28.5%	
0-40	1013	46.0%	
0-60	1725	78.3%	
0-90	2167	98.4%	
Total	0-180	2202	100%

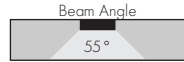

UNIT: CD
C0/180
C90/270

KXL-48-60X2VHO-30K-F
Kendo XL, 4ft, 3000K, VHO, Frosted Lens

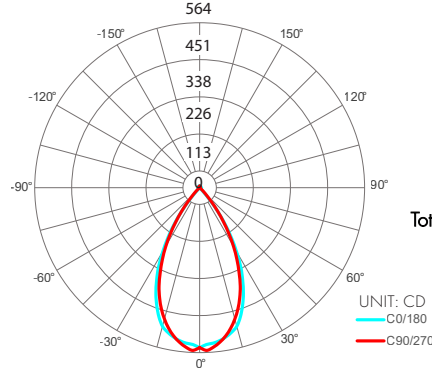

Zonal Lumen Summary 3000K

Zone	Lumen	% Fixture	
0-30	417	25.5%	
0-40	692	42.3%	
0-60	1243	76.0%	
0-90	1611	98.4%	
Total	0-180	1636	100%

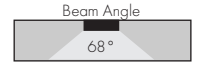

UNIT: CD
C0/180
C90/270

KXL-48-60X2VHO-30K-C
Kendo XL, 4ft, 3000K, VHO, Clear Lens

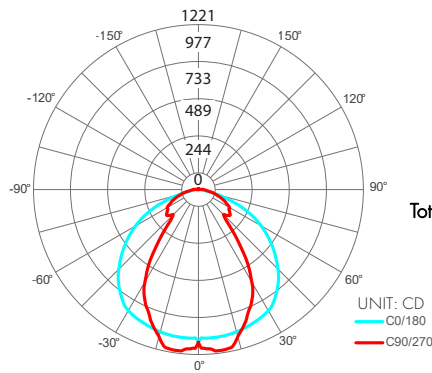

Zonal Lumen Summary 3000K

Zone	Lumen	% Fixture	
0-30	822	31.3%	
0-40	1278	48.6%	
0-60	2095	79.7%	
0-90	2604	99.1%	
Total	0-180	2628	100%

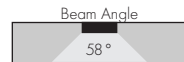

UNIT: CD
C0/180
C90/270

Power Consumption

Tested at Full Power with PDC Series power supplies.

*For Back Feed add 4/16" (1/4") to Actual Length. Standard Nominal Lengths offered provide minimal shadowing. For alternate lengths, please consult Inside Sales with specific request.

High Color Quality (60X2)

Nominal Length (in)	Side and End Feed Actual Length*	Watts		Nominal Length (in)	Side and End Feed Actual Length*	Watts		Nominal Length (in)	Side and End Feed Actual Length*	Watts		Nominal Length (in)	Side and End Feed Actual Length*	Watts	
		HO	VHO			HO	VHO			HO	VHO			HO	VHO
12	11 14/16	8.3	10.4	47	-	-	-	82	-	-	-	117	-	-	-
13	-	-	-	48	47	28.2	36.0	83	82 3/16	46.3	58.1	118	117 5/16	62.1	73.0
14	13 4/16	8.9	11.3	49	48 7/16	29.3	37.4	84	83 9/16	46.7	58.6	119	118 12/16	62.5	73.4
15	14 11/16	9.5	12.1	50	49 13/16	29.9	38.1	85	85	47.2	59.2	120	-	-	-
16	-	-	-	51	-	-	-	86	-	-	-	121	120 2/16	63.5	74.2
17	16 1/16	10.1	12.9	52	51 4/16	31.0	39.5	87	86 6/16	48.1	60.4	122	121 9/16	63.8	74.3
18	17 8/16	11.3	14.5	53	52 10/16	31.5	40.2	88	87 13/16	48.5	61.0	123	122 15/16	64.2	74.4
19	18 14/16	11.9	15.3	54	-	-	-	89	-	-	-	124	-	-	-
20	-	-	-	55	54 1/16	32.1	40.9	90	89 3/16	49.4	62.2	125	124 6/16	64.9	74.6
21	20 5/16	13.1	16.9	56	55 7/16	33.1	42.3	91	90 10/16	49.9	62.8	126	125 12/16	65.2	74.7
22	21 11/16	13.7	17.7	57	56 14/16	33.7	43.0	92	-	-	-	127	-	-	-
23	-	-	-	58	-	-	-	93	92	50.3	63.4	128	127 3/16	65.9	74.9
24	23 2/16	14.3	18.5	59	58 4/16	34.8	44.4	94	93 7/16	51.2	64.6	129	128 9/16	66.3	75.0
25	24 8/16	15.5	20.2	60	59 11/16	35.3	45.1	95	94 13/16	51.7	65.2	130	130	66.6	75.1
26	25 15/16	16.1	20.9	61	-	-	-	96	-	-	-	131	-	-	-
27	-	-	-	62	61 1/16	35.9	45.8	97	96 4/16	52.6	66.4	132	131 6/16	67.3	75.3
28	27 5/16	17.3	22.4	63	62 8/16	36.9	47.0	98	97 10/16	53.0	66.7	133	132 13/16	67.6	75.4
29	28 12/16	17.9	23.2	64	63 14/16	37.4	47.6	99	-	-	-	134	-	-	-
30	-	-	-	65	-	-	-	100	99 1/16	53.5	66.9	135	134 3/16	68.2	75.8
31	30 2/16	19.1	24.7	66	65 5/16	38.4	48.7	101	100 7/16	54.4	67.4	136	135 10/16	68.5	76.0
32	31 9/16	19.7	25.4	67	66 11/16	38.9	49.3	102	101 14/16	54.8	67.6	137	-	-	-
33	32 15/16	20.3	26.2	68	-	-	-	103	-	-	-	138	137	68.8	76.2
34	-	-	-	69	68 2/16	39.4	49.9	104	103 4/16	55.7	68.1	139	138 7/16	69.3	76.7
35	34 6/16	21.6	27.7	70	69 8/16	40.4	51.1	105	104 11/16	56.1	68.4	140	139 13/16	69.6	76.9
36	35 12/16	22.2	28.4	71	70 15/16	40.9	51.7	106	-	-	-	141	-	-	-
37	-	-	-	72	-	-	-	107	106 1/16	56.5	68.6	142	141 4/16	70.2	77.4
38	37 3/16	23.3	29.9	73	72 5/16	41.9	52.9	108	107 8/16	57.4	69.1	143	142 10/16	70.5	77.6
39	38 9/16	23.9	30.5	74	73 12/16	42.4	53.5	109	108 14/16	57.9	69.3	144	-	-	-
40	40	24.4	31.2	75	-	-	-	110	-	-	-	-	-	-	-
41	-	-	-	76	75 2/16	43.2	54.5	111	110 5/16	58.8	70.1	-	-	-	-
42	41 6/16	25.5	32.6	77	76 9/16	43.7	55.0	112	111 11/16	59.3	70.5	-	-	-	-
43	42 13/16	26.0	33.3	78	77 15/16	44.1	55.5	113	-	-	-	-	-	-	-
44	-	-	-	79	-	-	-	114	113 2/16	59.7	70.9	-	-	-	-
45	44 3/16	27.1	34.7	80	79 6/16	45.0	56.6	115	114 8/16	60.7	71.8	-	-	-	-
46	45 10/16	27.7	35.3	81	80 12/16	45.4	57.1	116	115 15/16	61.1	72.2	-	-	-	-

Power Consumption

Tested at Full Power with PDC Series power supplies.

*For Back Feed add 4/16" (1/4") to Actual Length. Standard Nominal Lengths offered provide minimal shadowing. For alternate lengths, please consult Inside Sales with specific request.

High Efficacy (HE48)

Nominal Length (in)	Side and End Feed Actual Length*	Watts				Nominal Length (in)	Side and End Feed Actual Length*	Watts				Nominal Length (in)	Side and End Feed Actual Length*	Watts				Nominal Length (in)	Side and End Feed Actual Length*	Watts			
		LO	SO	MO	HO			LO	SO	MO	HO			LO	SO	MO	HO			LO	SO	MO	HO
12	10 7/16	1.7	2.5	3.5	5.7	47	-	-	-	-	82	81 5/16	12.5	19.9	23.9	42.2	117	116 12/16	17.5	27.7	34.3	58.7	
13	12 7/16	1.7	2.5	3.5	5.7	48	47 14/16	7.1	11.2	13.9	25.4	83	-	-	-	-	118	-	-	-	-		
14	-	-	-	-	-	49	-	-	-	-	84	83 5/16	12.8	20.3	24.5	43.1	119	118 12/16	17.8	28.1	34.9	59.6	
15	14 6/16	2.0	3.0	4.0	7.2	50	49 13/16	7.4	11.7	14.5	26.3	85	-	-	-	-	120	-	-	-	-		
16	-	-	-	-	-	51	-	-	-	-	86	85 4/16	13.1	20.8	25.1	44.1	121	120 11/16	18.1	28.6	35.5	60.5	
17	16 6/16	2.4	3.5	4.6	8.7	52	51 13/16	7.7	12.3	15.1	27.4	87	-	-	-	-	122	-	-	-	-		
18	-	-	-	-	-	53	-	-	-	-	88	87 4/16	13.4	21.3	25.7	45.0	123	122 11/16	18.3	29.0	36.0	62.1	
19	18 5/16	2.7	3.9	5.2	10.2	54	53 12/16	8.0	12.9	15.7	28.5	89	-	-	-	-	124	-	-	-	-		
20	-	-	-	-	-	55	-	-	-	-	90	89 3/16	13.7	21.7	26.3	46.0	125	124 10/16	18.4	29.5	36.6	63.8	
21	20 5/16	3.0	4.4	5.8	11.7	56	55 12/16	8.4	13.5	16.4	29.5	91	-	-	-	-	126	-	-	-	-		
22	-	-	-	-	-	57	-	-	-	-	92	91 3/16	14.0	22.1	26.9	47.0	127	126 10/16	18.6	29.9	37.2	65.4	
23	22 4/16	3.4	4.9	6.4	13.2	58	57 11/16	8.7	14.0	17.0	30.6	93	-	-	-	-	128	-	-	-	-		
24	-	-	-	-	-	59	-	-	-	-	94	93 2/16	14.3	22.6	27.5	47.9	129	128 9/16	18.8	30.4	37.7	67.0	
25	24 4/16	3.7	5.4	7.0	14.7	60	59 11/16	9.0	14.6	17.6	31.6	95	-	-	-	-	130	-	-	-	-		
26	-	-	-	-	-	61	-	-	-	-	96	95 2/16	14.4	22.8	27.8	48.4	131	130 9/16	18.9	30.8	38.3	68.6	
27	26 3/16	4.1	5.9	7.5	15.8	62	61 10/16	9.4	15.2	18.2	32.6	97	-	-	-	-	132	-	-	-	-		
28	-	-	-	-	-	63	-	-	-	-	98	97 1/16	14.7	23.3	28.5	49.4	133	132 8/16	19.1	31.2	38.9	70.2	
29	28 3/16	4.4	6.4	8.1	16.8	64	63 10/16	9.7	15.6	18.7	33.7	99	-	-	-	-	134	-	-	-	-		
30	-	-	-	-	-	65	-	-	-	-	100	99 1/16	15.0	23.7	29.0	50.4	135	134 8/16	19.3	31.8	39.4	70.7	
31	30 2/16	4.8	6.9	8.7	17.9	66	65 9/16	10.0	16.1	19.2	34.7	101	-	-	-	-	136	-	-	-	-		
32	-	-	-	-	-	67	-	-	-	-	102	101	15.3	24.1	29.6	51.3	137	136 7/16	19.5	32.3	40.0	71.2	
33	32 2/16	5.0	7.2	9.0	18.5	68	67 9/16	10.4	16.5	19.8	35.7	103	103	15.6	24.6	30.2	52.3	138	-	-	-	-	
34	-	-	-	-	-	69	-	-	-	-	104	-	-	-	-	-	139	138 7/16	19.8	32.8	40.6	71.8	
35	34 1/16	5.4	7.7	9.6	19.5	70	69 8/16	10.7	17.0	20.3	36.7	105	104 15/16	15.8	25.0	30.7	53.2	140	-	-	-	-	
36	-	-	-	-	-	71	-	-	-	-	106	-	-	-	-	-	141	140 6/16	20.0	33.3	41.1	72.3	
37	36 1/16	5.7	8.2	10.2	20.6	72	71 8/16	11.0	17.4	20.8	37.7	107	106 15/16	16.1	25.5	31.3	54.2	142	-	-	-	-	
38	-	-	-	-	-	73	-	-	-	-	108	-	-	-	-	-	143	142 6/16	20.2	33.9	41.7	72.8	
39	38	6.0	8.7	10.8	21.5	74	73 7/16	11.3	17.9	21.4	38.7	109	108 14/16	16.4	25.9	31.9	55.2	144	-	-	-	-	
40	40	6.2	9.2	11.4	22.3	75	-	-	-	-	110	-	-	-	-	-	-	-	-	-	-	-	
41	-	-	-	-	-	76	75 7/16	11.6	18.4	22.0	39.6	111	110 14/16	16.7	26.4	32.5	56.1	-	-	-	-	-	
42	41 15/16	6.4	9.7	12.0	23.1	77	-	-	-	-	112	-	-	-	-	-	-	-	-	-	-	-	
43	-	-	-	-	-	78	77 6/16	11.9	18.9	22.7	40.5	113	112 13/16	17.0	26.8	33.1	57.0	-	-	-	-	-	
44	43 15/16	6.7	10.2	12.6	23.9	79	-	-	-	-	114	-	-	-	-	-	-	-	-	-	-	-	
45	-	-	-	-	-	80	79 6/16	12.2	19.4	23.3	41.4	115	114 13/16	17.3	27.3	33.7	57.9	-	-	-	-	-	
46	45 14/16	6.9	10.7	13.3	24.7	81	-	-	-	-	116	-	-	-	-	-	-	-	-	-	-	-	

Power Consumption

Tested at Full Power with PDC Series power supplies.

*For Back Feed add 4/16" (1/4") to Actual Length. Standard Nominal Lengths offered provide minimal shadowing. For alternate lengths, please consult Inside Sales with specific request.

High Efficacy (HE64)

Nominal Length (in)	Side and End Feed Actual Length*	Watts		Nominal Length (in)	Side and End Feed Actual Length*	Watts		Nominal Length (in)	Side and End Feed Actual Length*	Watts		Nominal Length (in)	Side and End Feed Actual Length*	Watts	
		VHO	XHO			VHO	XHO			VHO	XHO			VHO	XHO
12	11 4/16	7.6	9.7	47	46 1/16	28.2	35.9	82	-	-	-	117	-	-	-
13	12 12/16	7.6	9.7	48	47 9/16	29.5	37.6	83	82 6/16	51.7	63.4	118	117 4/16	72.8	80.7
14	-	-	-	49	-	-	-	84	83 15/16	52.3	63.8	119	118 12/16	73.3	81.0
15	14 4/16	8.9	11.3	50	49 1/16	30.1	38.4	85	-	-	-	120	-	-	-
16	15 12/16	9.5	12.1	51	50 10/16	31.4	40.2	86	85 7/16	53.6	64.7	121	120 4/16	74.4	81.7
17	-	-	-	52	-	-	-	87	86 15/16	54.2	65.3	122	121 12/16	74.8	82.0
18	17 5/16	10.7	13.6	53	52 2/16	32.0	41.1	88	-	-	-	123	-	-	-
19	18 13/16	11.4	14.4	54	53 10/16	33.3	42.9	89	88 7/16	55.5	66.3	124	123 4/16	75.6	82.5
20	-	-	-	55	-	-	-	90	89 15/16	56.2	66.8	125	124 13/16	76.0	82.8
21	20 5/16	12.6	16.0	56	55 2/16	34.0	43.8	91	-	-	-	126	-	-	-
22	21 13/16	13.2	16.8	57	56 10/16	35.2	45.5	92	91 8/16	57.5	67.9	127	126 5/16	76.8	83.4
23	-	-	-	58	-	-	-	93	93	58.2	68.4	128	127 13/16	77.2	83.6
24	23 5/16	14.5	18.3	59	58 3/16	36.5	47.3	94	-	-	-	129	-	-	-
25	24 14/16	15.1	19.1	60	59 11/16	37.2	48.2	95	94 8/16	59.5	69.5	130	129 5/16	78.0	84.2
26	-	-	-	61	-	-	-	96	-	-	-	131	130 14/16	78.4	84.5
27	26 6/16	16.4	20.7	62	61 3/16	38.4	50.0	97	96	60.1	70.0	132	-	-	-
28	27 14/16	17.0	21.4	63	62 11/16	39.1	50.8	98	97 9/16	61.4	71.1	133	132 6/16	79.2	85.0
29	-	-	-	64	-	-	-	99	-	-	-	134	133 14/16	79.6	85.4
30	29 6/16	18.2	23.0	65	64 4/16	40.4	52.5	100	99 1/16	62.0	71.7	135	-	-	-
31	30 15/16	18.9	23.8	66	65 12/16	41.0	53.4	101	100 9/16	63.2	72.9	136	135 6/16	80.3	86.2
32	-	-	-	67	-	-	-	102	-	-	-	137	136 14/16	80.6	86.6
33	32 7/16	20.1	25.3	68	67 4/16	42.3	55.1	103	102 1/16	63.8	73.5	138	-	-	-
34	33 15/16	20.7	26.1	69	68 12/16	42.9	55.9	104	103 9/16	65.0	74.7	139	138 7/16	81.3	87.5
35	-	-	-	70	-	-	-	105	-	-	-	140	139 15/16	81.7	87.9
36	35 7/16	22.0	27.6	71	70 4/16	44.2	57.6	106	105 2/16	65.6	75.3	141	-	-	-
37	36 15/16	22.6	28.4	72	71 13/16	44.9	58.5	107	106 10/16	66.8	76.5	142	141 7/16	82.4	88.7
38	-	-	-	73	-	-	-	108	-	-	-	143	142 15/16	82.7	89.1
39	38 8/16	23.9	30.1	74	73 5/16	46.1	59.7	109	108 2/16	67.4	77.1	144	-	-	-
40	40	24.5	30.9	75	74 13/16	46.7	60.1	110	109 10/16	68.5	78.0				
41	-	-	-	76	-	-	-	111	-	-	-				
42	41 8/16	25.7	32.6	77	76 5/16	48.0	60.9	112	111 3/16	69.6	78.7				
43	-	-	-	78	77 14/16	48.6	61.3	113	112 11/16	70.1	79.0				
44	43	26.4	33.4	79	-	-	-	114	-	-	-				
45	44 9/16	27.6	35.1	80	79 6/16	49.8	62.2	115	114 3/16	71.2	79.7				
46	-	-	-	81	80 14/16	50.4	62.6	116	115 11/16	71.7	80.0				

Voltage Drop Calculator

The below chart assumes nominal voltage of 24 Volts and a Voltage Drop Allowance of 3% through the wire

Wattage [W]	Maximum Wire Length From Power Supply to Start of Run [ft]						
	12 AWG	14 AWG	16 AWG	18 AWG	20 AWG	22 AWG	24 AWG
5	1088.2	684.4	430.3	270.6	170.2	107.1	67.3
10	544.1	342.2	215.1	135.3	85.1	53.5	33.7
15	362.7	228.1	143.4	90.2	56.7	35.7	22.4
20	272.0	171.1	107.6	67.7	42.6	26.8	16.8
25	217.6	136.9	86.1	54.1	34.0	21.4	13.5
30	181.4	114.1	71.7	45.1	28.4	17.8	11.2
35	155.5	97.8	61.5	38.7	24.3	15.3	9.6
40	136.0	85.5	53.8	33.8	21.3	13.4	8.4
45	120.9	76.0	47.8	30.1	18.9	11.9	7.5
50	108.8	68.4	43.0	27.1	17.0	10.7	6.7
55	98.9	62.2	39.1	24.6	15.5	9.7	6.1
60	90.7	57.0	35.9	22.6	14.2	8.9	5.6
65	83.7	52.6	33.1	20.8	13.1	8.2	5.2
70	77.7	48.9	30.7	19.3	12.2	7.6	4.8
75	72.5	45.6	28.7	18.0	11.3	7.1	4.5
80	68.0	42.8	26.9	16.9	10.6	6.7	4.2
85	64.0	40.3	25.3	15.9	10.0	6.3	4.0
90	60.5	38.0	23.9	15.0	9.5	5.9	3.7
96	56.7	35.6	22.4	14.1	8.9	5.6	3.5

Power Supplies

See Power Supply instructions and spec sheet for wiring information. For a complete list of compatible dimmers, see Compatible Dimming Chart on the Resources page.

Universal Power Supply 1% 120VAC - 277VAC

MODEL	POWER	OUTPUT
PDCU-D - IP20 Dry Series	30 - 30 W 60 - 60 W 96 - 96 W 3X96 - 3X96 W	24 - 24 VDC
PDCU-W - IP66 Wet Series	96 - 96 W 3X96 - 3X96 W	

0-10V dims down to 1%, MLV/ELV/TRIAC dims down to 1%.
For a complete list of compatible dimmers, see [Compatible Dimming Chart](#) on the Resources page.

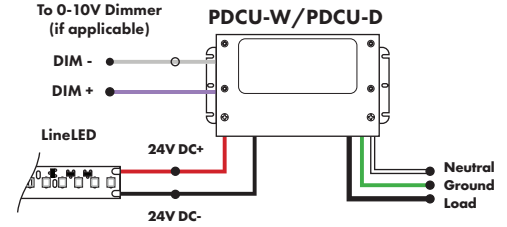

MODELS	PDCU-W 96W	PDCU-W 3X96W	PDCU-D 30W	PDCU-D 60W	PDCU-D 96W	PDCU-D 3X96W
Length	8.66"	11.85"	6.10"	7.93"	8.25"	9.57"
Width	3.73"	4.32"	3.35"	3.35"	4.10"	5.94"
Depth	1.61"	1.81"	1.33"	1.32"	1.56"	1.13"

0-10V Dimming Power Supplies 0.1% 120VAC - 277VAC

MODEL	POWER	OUTPUT	DIMMING
PS010V - 0-10V Power Supply dims down to 0.1%	96 - 96 Watt 3X96 - 3 X 96 Watt	24 - 24 VDC	LIN - Linear LOG - Logarithmic

MODELS	96W	3X96
Length	14.40"	15.75"
Width	5.20"	6.62"
Depth	2.60"	4.95"

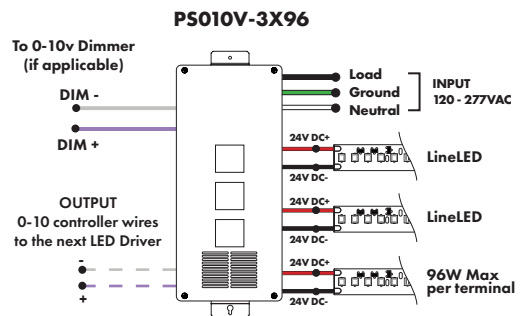
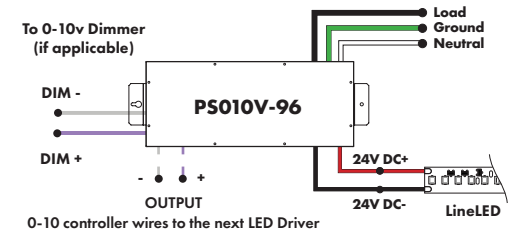

Triac, MLV, & ELV Compatible Dimmers

MODEL	POWER	OUTPUT
PDC - (IP20) Power Supply	96 - 96 Watts	24 - 24 VDC

MODELS	96W
Length	8.25"
Width	4.10"
Depth	1.56"

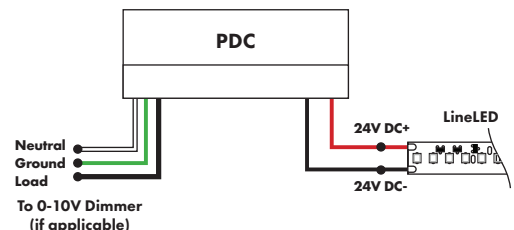

Power Supplies

See Power Supply instructions and spec sheet for wiring information. For a complete list of compatible dimmers, see Compatible Dimming Chart on the Resources page.

DMX Dimming Power Supplies 120VAC - 277VAC

MODEL	POWER	OUTPUT
PSDMX - DMX Power Supply dims down to 0%	96 - 96 Watt 3X96 - 3 X 96 Watt	24 - 24 VDC

Features eldoLED's LINEARdrive configurable dimmable drivers

MODELS	96W	3X96
Length	14.40"	15.75"
Width	5.20"	6.62"
Depth	2.60"	4.95"

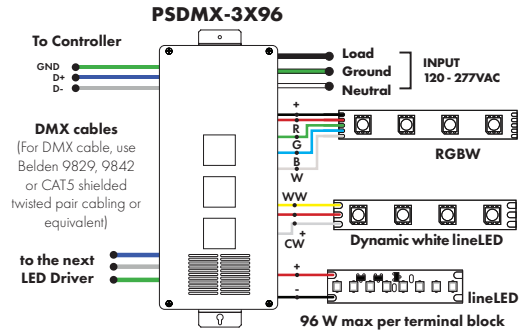
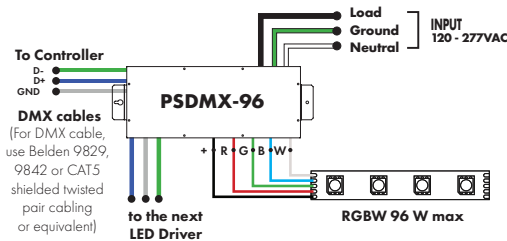

DALI 0% Dimming Power Supplies 120VAC - 277VAC

MODEL	POWER	OUTPUT
PSDALI - DALI Power Supply dims down to 0%	96 - 96 Watt 3X96 - 3 X 96 Watt	24 - 24 VDC

Features eldoLED's LINEARdrive configurable dimmable drivers

Model	96W	3X96
Length	14.40"	15.75"
Width	5.20"	6.62"
Depth	2.60"	4.95"

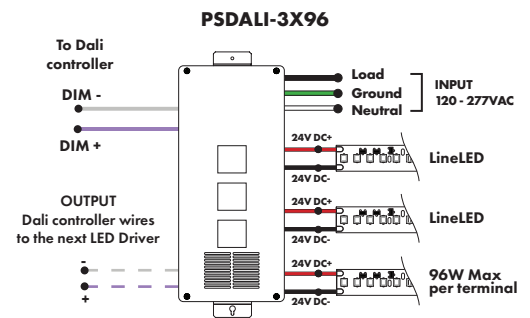
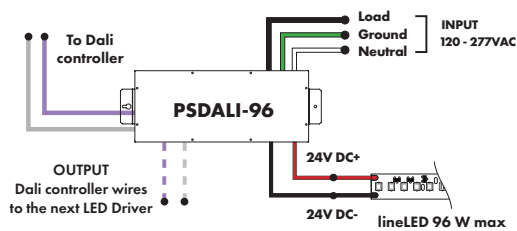

Enlighted Enabled Dimming Power Supplies 120VAC - 277VAC

MODEL	POWER	OUTPUT	DIMMING	LOCATION
PSV - PSV Series	96 - 96 Watt	24 - 24 VDC	ENL - Enlighted Dimming dims down to 0%	D - Damp

Model	96W
Length	14.40"
Width	5.20"
Depth	2.60"

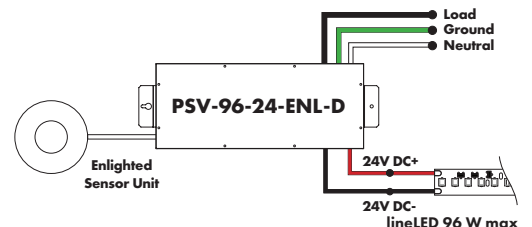

Power Supplies

See Power Supply instructions and spec sheet for wiring information. For a complete list of compatible dimmers, see Compatible Dimming Chart on the Resources page.

Non-Dimming Power Supply 120VAC - 277VAC

MODEL	POWER	OUTPUT	DIMMING	LOCATION
PSV - PSV Series	96 - 96 Watt	24 - 24 VDC	ND - Non Dimming	D - Damp

MODELS	96W
Length	14.40"
Width	5.20"
Depth	2.60"

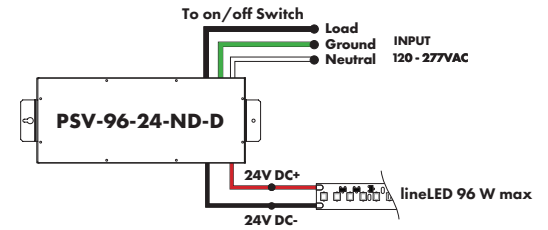

Luminii is a Lutron OEM Advantage Partner

Lutron Power Supplies 1%

MODEL
L3DA4U1UKL-CV240

HiLume™ 1% EcoSystem Voltage LED driver
40W max

MODELS	L3DA4U1UKL-CV240
Length	4.98"
Width	4.00"
Depth	2.62"

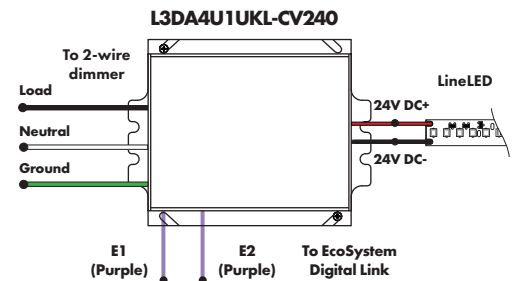

Luminii is a Lutron OEM Advantage Partner

Lutron Power Supplies 0.1%

MODEL
L3D0-96W24V-U

HiLume™ 0.1% EcoSystem Voltage LED Driver with Soft-On, Fade-to-Black™
96W max

MODELS	L3D0
Length	10.50"
Width	5.50"
Depth	2.00"

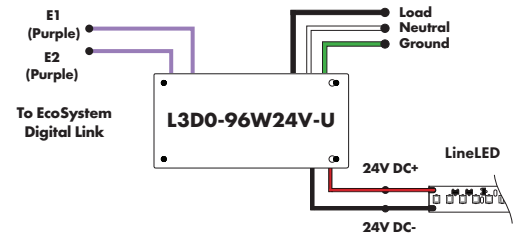

In-Ground Power Supplies

MODEL	POWER	OUTPUT	INPUT
IG - In ground CVE Series CVE - ELV Dimming DALI - eldoLED Dali dimming Both dims down to 0%	96X2 - 2 X 96 Watt	24 - 24 VDC	Blank - 120 V 277 - 240/277 V

MODELS	Dual Circuit
Length	8.40"
Width	8.30"
Depth	8.10"

