

Clareo S

Clareo Q

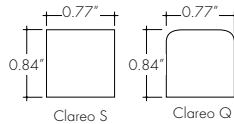
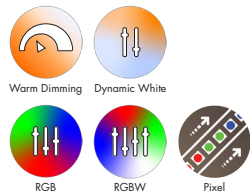

## Features

- 24VDC Class 2 fixtures made to order up to 144". Fixtures can be linked up to 30' depending on output
- Suitable for direct view, vanity, and accent lighting applications
- Approved for closet/storage space installation per NEC 410.16(A) (3) and 410.16(C)(5)
- Class two listed for damp locations.
- Dot free even illumination with frosted lens
- 5 year warranty
- Proprietary strong bond solder method handles up to 50 lbs of pull force on wire leads and connectors.
- Warm Dim follows the incandescent dimming curve and is compatible with MLV, ELV, and Incandescent dimmers.
- RGB options offer balanced output across the color gamut and a true white with RGBW
- Smart Pixel offerings allow for infinite color combinations with cascading and chasing effects.

## Finish Options (see page 2 for additional information)

- Silver Anodized
- Black
- Bronze
- White
- Matte Black
- Warm Nickel
- Aged Brass
- Polished Gold
- Chrome



## Technical Information

TYPE	Warm Dim	Dynamic White		RGBW		RGB		Pixel	
OUTPUT OPTIONS	WD68SO (19K-27K)	DW60X2HO (27K-65K)	DW60X2VHO (27K-65K)	RGBW36SO	RGBW36HO	RGB42SO	RGB42HO	RGBWX18SO	RGBX18SO
Lumens Output (all channels full on) (with a Frosted Lens)	226 lm/ft	442 lm/ft	559 lm/ft	138 lm/ft	228 lm/ft	137 lm/ft	201 lm/ft	166 lm/ft	110 lm/ft
Average Power Consumption (for a 4" section)	5.4 W/ft	7.3 W/ft	9.4 W/ft	4 W/ft	7.6 W/ft	4.5 W/ft	8.3 W/ft	5.7 W/ft	4.5 W/ft
Efficacy	42 lm/W	61 lm/W	59 lm/W	35 lm/W	30 lm/W	30 lm/W	24 lm/W	29 lm/W	24 lm/W
Max Run Length (in series)	20 ft	26 ft	13 ft	26 ft	13 ft	28 ft	13 ft	20 ft	30 ft
Max Ambient Temperature*	50°C [122°F]	50°C [122°F]		50°C [122°F]				50°C [122°F]	
Control/Dimming Protocol	MLV, ELV, Inc.	0-10V, DMX		DMX				SPI Protocol UCS 2904	SPI Protocol UCS 2903

\*Max Ambient Temperature to maintain L70 of 50k+ hours. Exceeding Max Ambient Temperature may result in decreased life/output. Consult Technical Support for specific inquiries.

Warm Dim (WD68)					Dynamic White (DW60X2)					RGBW (3000K)				Dominant Wavelength		
CCT	CRI	TM-30			CCT	CRI	TM-30			Tape	CRI	TM-30		Color	RGB42/RGBW36	
		R <sub>f</sub>	R <sub>g</sub>	R <sub>9</sub>			R <sub>f</sub>	R <sub>g</sub>	R <sub>9</sub>			R <sub>f</sub>	R <sub>g</sub>			R <sub>9</sub>
1900K	96	92	96	94	1900K	97	94	98	95	RGBW36	95	93	106	84	Red	620nm
2700K	96	93	106	95	2700K	98	96	101	91	RGBWX18	93	91	99	64	Green	525nm
					2900K	98	96	102	94	DW68				Blue	467nm	
					3500K	97	94	105	97	CCT	Multiplier					
					4400K	97	91	101	97	27K - 65K	1.00					
					6500K	92	88	97	64	19K - 35K	0.78					

## Ordering Code

MODEL	LENGTH <sup>1</sup>	OUTPUT	CCT	LENS <sup>2</sup>	MOUNTING	FINISH <sup>3</sup>	POSITION TYPE	POWER FEED
CLS - Clareo S CLQ - Clareo Q	12"-144" 3" increments	WD68SO - Standard	19K27K - 1900K - 2700K	F - Frosted	FC - Fixed Clip SC - Screw-in MAG - Magnetic Mounting A - Adjustable Hinge Mounting TB9 - 9/16" TBar TB15 - 15/16" TBar	SA - Silver Anodized BK - Black BZ - Bronze WH - White MBK - Matte Black WN - Warm Nickel AB - Aged Brass PG - Polished Gold <sup>4</sup> CH - Chrome <sup>4</sup>	E - End B - Back	1 - 72" wire leads 1X2 - 72" wire leads at both ends 2 - 72" wire leads at one end and Quick Connect at other 3 - Single Quick Connect 4 - Dual Quick Connect
	12"-144" 2" increments	DW60X2HO - Standard DW60X2VHO - High	19K35K - 1900K - 3500K 27K65K - 2700K - 6500K					
	12"-144" 2" increments	RGBW36SO - Standard RGBW36HO - High RGB42SO - Standard RGB42HO - High	CLR - Color					
	12"-144" 4" increments	RGBWX18SO - Standard RGBX18SO - Standard	PXSPI - Smart Pixel Control					

1 - Custom lengths and increments are available, please consult Inside Sales with specific request.

2 - Warm Dim and Dynamic White options can be used to comply with Title 24 JAB at max brightness depending on lens selection, see multiplier charts to calculate specific efficacy.

3 - Non SA finishes may have extended lead times. Custom RALs are available, please consult Inside Sales with specific request.

4 - Polished Gold finishes have a maximum fixture length of 48", and Chrome finishes have a maximum fixture length of 72".

**Product Dimensions**

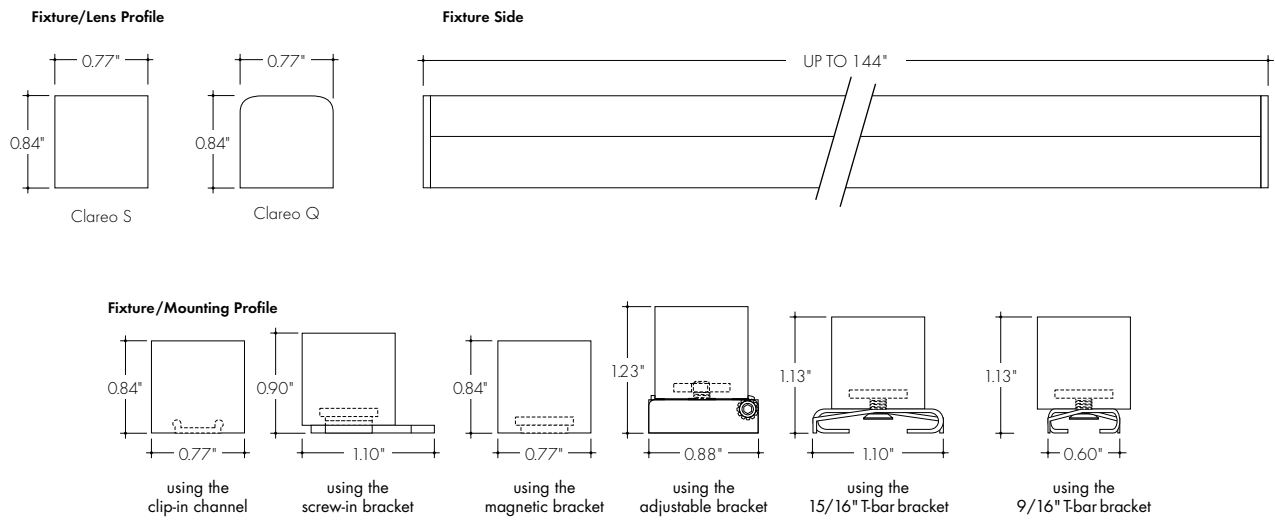

**Finish Options**

- Finish options are available in a wide variety, allowing for complete customization of style and aesthetic.
- Non Silver Anodized finishes may have extended lead times.
- Polished Gold finishes have a maximum fixture length of 48", and Chrome finishes have a maximum fixture length of 72".
- Custom RALs are available, please consult Inside Sales with specific request.

**Silver Anodized**



Silver Anodized is a soft silver with a clear finish.

**Black**



Black is a true deep black with a glossy finish.

**Bronze**



Bronze is a rich, dark brown with a satin finish.

**White**

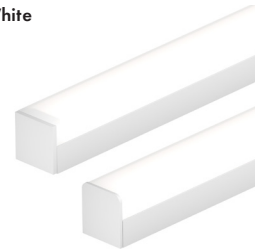

White is a polar bright white and field paintable.

**Matte Black**

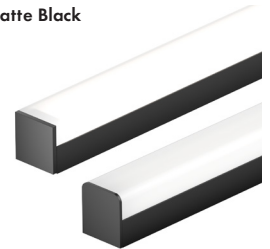

Matte Black is a dark, pitch-black with a soft flat finish.

**Warm Nickel**

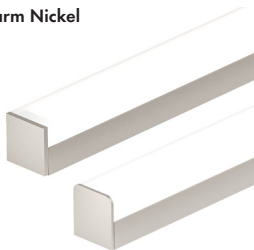

Warm Nickel is a soft, silvery smoke with warm tones and a satin finish.

**Aged Brass**



Aged Brass is a deep brown shade with slightly golden undertones.

**Polished Gold**



Polished Gold is bright and radiant for a brilliant finish.

**Chrome**



Chrome is a highly reflective silver polish.

**Powerfeeds and Connectors**

**Linking and Extension Cable Options**

For use with Warm Dim (WD68):

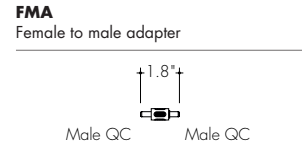
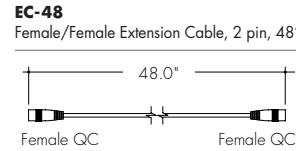
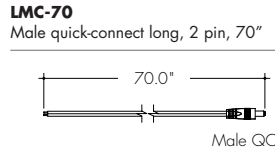
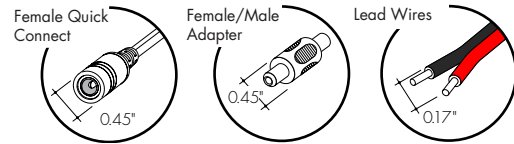

For use with Dynamic White (DW60X2), RGB Pixel (RGBX18) and RGBW Pixel (RGBWX18):

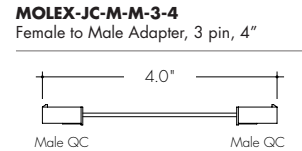
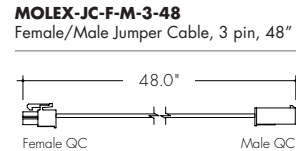
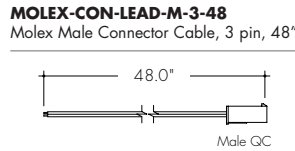
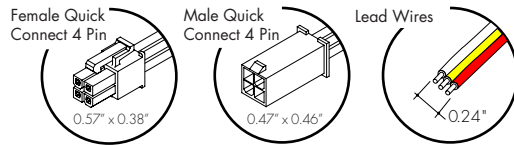

For use with RGB (RGB42):

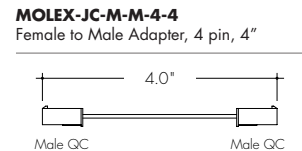
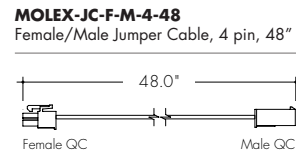
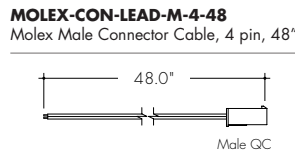
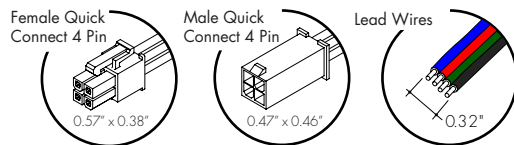

For use with RGBW (RGBW36):

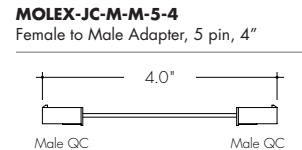
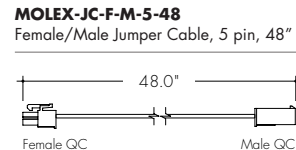
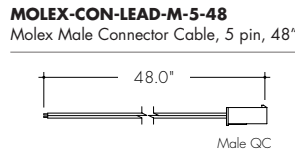
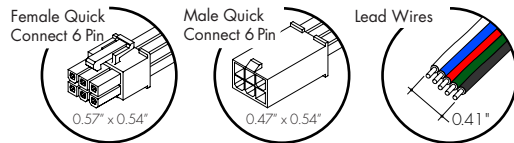

**Powerfeeds Position/Type**

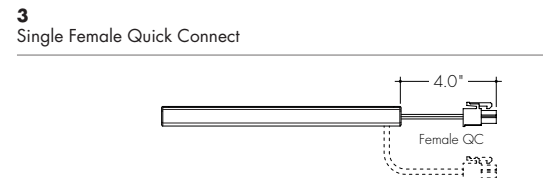
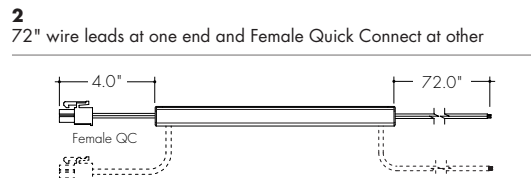
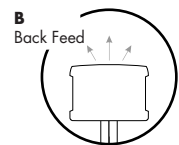
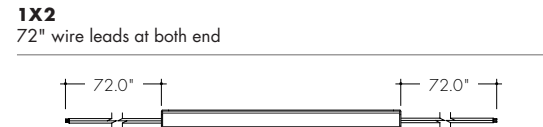
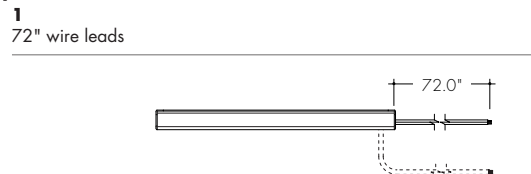
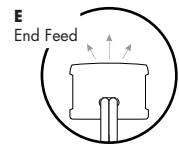

Side and Back feeds shown as dashed lines  
All wires are 18 AWG unless otherwise specified

**Sample Layout**

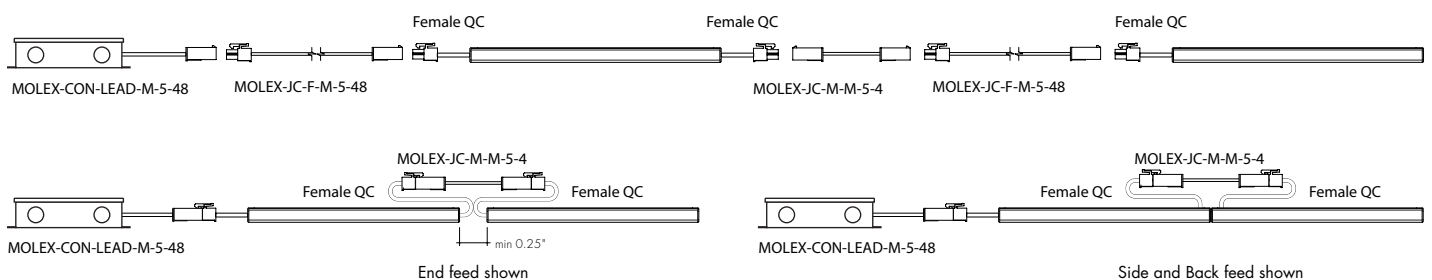

**Lens Option / Light Transmission**

Output Options	Lens/Accessory	
	Frosted Lens Rounded Square	Frosted Lens Square
WD68SO - 27K	ND	ND
WD68SO - 19K	ND	ND
DW68SO (All On)	ND	ND
DW68SO (1-Channel)	ND	ND
DW68HO (All On)	ND	ND
DW68HO (1-Channel)	ND	ND
RGBW36SO	ND	ND
RGBW36HO	ND	ND
RGB42SO	ND	ND
RGB42HO	ND	ND
RGBWX18SO	SD	SD
RGBX18SO	SD	SD
<b>Transmission Percentage</b>	100%	96%

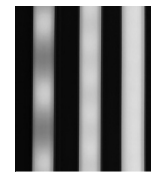

**CD SD ND**  
**CD** - Clear Dotting  
**SD** - Slight Dotting  
**ND** - No Dotting

**Accessory Options**

**LVSP-4T-BK**

Low Voltage, 4 Terminal Splice Box, Black

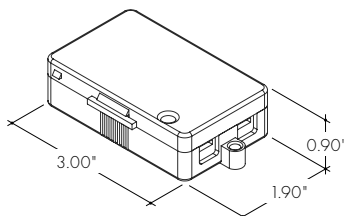

**Power Consumption**

Tested at Full Power with PDC Series power supplies.

\*For Back Feed add 4/16" (1/4") to Actual Length. Standard Nominal Lengths offered provide minimal shadowing. For alternate lengths, please consult Inside Sales with specific request.

**Warm Dim (WD68)**

Nominal Length (in)	End Feed Actual Length*	Watts SO	Nominal Length (in)	End Feed Actual Length*	Watts SO	Nominal Length (in)	End Feed Actual Length*	Watts SO	Nominal Length (in)	End Feed Actual Length*	Watts SO
12	10 11/16	4.6	47	-	-	82	-	-	117	116 8/16	47.5
13	-	-	48	47 10/16	21.0	83	82 1/16	34.8	118	-	-
14	13 3/16	5.8	49	-	-	84	-	-	119	119	48.3
15	-	-	50	-	-	85	84 9/16	35.7	120	-	-
16	15 10/16	6.9	51	50 1/16	22.0	86	-	-	121	-	-
17	-	-	52	-	-	87	87	36.7	122	121 7/16	49.1
18	-	-	53	52 9/16	23.0	88	-	-	123	-	-
19	18 2/16	8.0	54	-	-	89	-	-	124	123 15/16	49.9
20	-	-	55	-	-	90	89 7/16	37.6	125	-	-
21	20 9/16	9.1	56	55	24.1	91	-	-	126	-	-
22	-	-	57	-	-	92	91 15/16	38.6	127	126 6/16	50.6
23	-	-	58	57 8/16	25.1	93	-	-	128	-	-
24	23	10.2	59	-	-	94	-	-	129	128 13/16	51.5
25	-	-	60	59 15/16	26.1	95	94 6/16	39.6	130	-	-
26	25 8/16	11.3	61	-	-	96	-	-	131	-	-
27	-	-	62	-	-	97	96 13/16	40.5	132	131 5/16	52.5
28	27 15/16	12.3	63	62 6/16	27.1	98	-	-	133	-	-
29	-	-	64	-	-	99	-	-	134	133 12/16	53.3
30	-	-	65	64 14/16	28.0	100	99 5/16	41.4	135	-	-
31	30 6/16	13.4	66	-	-	101	-	-	136	-	-
32	-	-	67	-	-	102	101 12/16	42.2	137	136 3/16	54.2
33	32 14/16	14.5	68	67 5/16	29.0	103	-	-	138	-	-
34	-	-	69	-	-	104	-	-	139	138 11/16	54.8
35	-	-	70	69 12/16	30.0	105	104 4/16	43.0	140	-	-
36	35 5/16	15.6	71	-	-	106	-	-	141	-	-
37	-	-	72	-	-	107	106 11/16	43.9	142	141 2/16	55.4
38	37 13/16	16.7	73	72 4/16	30.9	108	-	-	143	-	-
39	-	-	74	-	-	109	-	-	144	143 9/16	56.2
40	-	-	75	74 11/16	32.0	110	109 2/16	44.8			
41	40 4/16	17.8	76	-	-	111	-	-			
42	-	-	77	-	-	112	111 10/16	45.8			
43	42 11/16	18.9	78	77 2/16	33.1	113	-	-			
44	-	-	79	-	-	114	-	-			
45	-	-	80	79 10/16	33.9	115	114 1/16	46.6			
46	45 3/16	20.0	81	-	-	116	-	-			

**Power Consumption**

Tested at Full Power with PDC Series power supplies.

\*For Back Feed add 4/16" (1/4") to Actual Length. Standard Nominal Lengths offered provide minimal shadowing. For alternate lengths, please consult Inside Sales with specific request.

**Dynamic White (DW60X2)**

Nominal Length (in)	End Feed Actual Length*	Watts		Nominal Length (in)	End Feed Actual Length*	Watts		Nominal Length (in)	End Feed Actual Length*	Watts		Nominal Length (in)	End Feed Actual Length*	Watts	
		HO	VHO			HO	VHO			HO	VHO			HO	VHO
12	10 11/16	7.7	10.4	47	-	-	-	82	81	43.6	58.6	117	116 3/16	58.6	77.4
13	12 2/16	7.7	10.4	48	47 4/16	25.5	36.7	83	82 7/16	44.5	59.7	118	117 9/16	59.6	78.5
14	13 8/16	8.4	11.2	49	48 11/16	26.6	38.1	84	83 13/16	44.9	60.2	119	119	60.1	79.1
15	14 15/16	9.1	12.1	50	-	-	-	85	-	-	-	120	-	-	-
16	-	-	-	51	50 1/16	27.1	38.8	86	85 4/16	45.4	60.8	121	120 6/16	61.1	80.3
17	16 5/16	9.8	12.9	52	51 8/16	28.2	40.2	87	86 10/16	46.2	61.9	122	121 13/16	61.5	80.8
18	17 12/16	11.1	14.6	53	52 14/16	28.7	40.9	88	-	-	-	123	-	-	-
19	-	-	-	54	-	-	-	89	88 1/16	46.6	62.5	124	123 3/16	61.8	81.3
20	19 2/16	11.8	15.4	55	54 5/16	29.2	41.6	90	89 7/16	47.3	63.7	125	124 10/16	62.4	82.2
21	20 9/16	13.1	17.1	56	55 11/16	30.3	42.9	91	90 14/16	47.7	64.3	126	-	-	-
22	21 15/16	13.8	18.0	57	-	-	-	92	-	-	-	127	126	62.8	82.7
23	-	-	-	58	57 2/16	30.8	43.6	93	92 4/16	48.1	64.9	128	127 7/16	63.4	83.7
24	23 6/16	14.5	18.8	59	58 8/16	31.8	45.0	94	93 11/16	48.9	66.0	129	128 13/16	63.8	84.2
25	24 12/16	15.8	20.5	60	59 15/16	32.4	45.7	95	-	-	-	130	-	-	-
26	-	-	-	61	-	-	-	96	95 1/16	49.2	66.6	131	130 4/16	64.1	84.7
27	26 3/16	16.2	21.3	62	61 5/16	32.9	46.4	97	96 8/16	50.0	67.8	132	131 10/16	64.8	85.7
28	27 9/16	16.9	22.8	63	62 12/16	34.0	47.8	98	97 14/16	50.4	68.3	133	-	-	-
29	29	17.2	23.6	64	-	-	-	99	-	-	-	134	133 1/16	65.1	86.2
30	-	-	-	65	64 2/16	34.6	48.4	100	99 5/16	50.9	68.7	135	134 7/16	65.5	86.7
31	30 6/16	17.9	25.2	66	65 9/16	35.8	49.7	101	100 11/16	51.7	69.6	136	135 14/16	65.7	87.0
32	31 13/16	18.3	26.0	67	66 15/16	36.4	50.4	102	-	-	-	137	-	-	-
33	-	-	-	68	-	-	-	103	102 2/16	52.2	70.1	138	137 4/16	65.8	87.2
34	33 3/16	18.6	26.8	69	68 6/16	37.0	51.0	104	103 8/16	53.0	71.0	139	138 11/16	66.2	87.8
35	34 10/16	19.3	28.3	70	69 12/16	38.1	52.4	105	104 15/16	53.5	71.5	140	-	-	-
36	-	-	-	71	-	-	-	106	-	-	-	141	140 1/16	66.4	88.0
37	36	19.7	29.1	72	71 3/16	38.7	53.0	107	106 5/16	53.9	71.9	142	141 8/16	66.8	88.6
38	37 7/16	20.6	30.6	73	72 9/16	39.9	54.3	108	107 12/16	54.7	72.9	143	142 14/16	66.9	88.8
39	38 13/16	21.1	31.2	74	74	40.3	54.9	109	-	-	-	144	-	-	-
40	-	-	-	75	-	-	-	110	109 2/16	55.2	73.3				
41	40 4/16	21.7	31.9	76	75 6/16	41.3	55.9	111	110 9/16	56.2	74.5				
42	41 10/16	22.8	33.3	77	76 13/16	41.7	56.5	112	111 15/16	56.7	75.1				
43	-	-	-	78	-	-	-	113	-	-	-				
44	43 1/16	23.3	34.0	79	78 3/16	42.2	57.0	114	113 6/16	57.2	75.6				
45	44 7/16	24.4	35.3	80	79 10/16	43.1	58.1	115	114 12/16	58.1	76.8				
46	45 14/16	25.0	36.0	81	-	-	-	116	-	-	-				

**Power Consumption**

Tested at Full Power with PDC Series power supplies.

\*For Back Feed add 4/16" (1/4") to Actual Length. Standard Nominal Lengths offered provide minimal shadowing. For alternate lengths, please consult Inside Sales with specific request.

**RGB/RGBW (RGB42/RGBW36)**

Nominal Length (in)	End Feed Actual Length*	Watts				Nominal Length (in)	End Feed Actual Length*	Watts				Nominal Length (in)	End Feed Actual Length*	Watts				Nominal Length (in)	End Feed Actual Length*	Watts			
		RGBW36		RGB42				RGBW36		RGB42				RGBW36		RGB42				RGBW36		RGB42	
		SO	HO	SO	HO			SO	HO	SO	HO			SO	HO	SO	HO			SO	HO	SO	HO
12	10 11/16	4.0	7.3	4.4	8.6	47	46 2/16	14.4	27.5	16.8	31.3	82	81 9/16	26.1	49.6	29.4	53.8	117	-	-	-	-	
13	12 11/16	4.0	7.3	4.4	8.6	48	-	-	-	-	-	83	-	-	-	-	-	118	117	37.1	66.2	41.3	73.1
14	-	-	-	-	-	49	48 2/16	15.1	28.8	17.5	32.7	84	83 9/16	26.8	50.8	30.0	55.0	119	119	37.8	67.5	41.9	74.0
15	14 10/16	4.5	8.5	5.2	10.0	50	-	-	-	-	-	85	-	-	-	-	-	120	-	-	-	-	
16	-	-	-	-	-	51	50 1/16	15.8	30.0	18.3	34.0	86	85 8/16	27.4	51.9	30.7	56.2	121	120 15/16	38.6	68.7	42.6	74.9
17	16 10/16	5.1	9.7	5.9	11.3	52	-	-	-	-	-	87	-	-	-	-	-	122	-	-	-	-	
18	-	-	-	-	-	53	52 1/16	16.4	31.2	18.9	35.1	88	87 8/16	28.0	52.9	31.4	57.3	123	122 15/16	39.2	69.7	43.2	75.3
19	18 9/16	5.6	10.9	6.7	12.6	54	-	-	-	-	-	89	-	-	-	-	-	124	-	-	-	-	
20	-	-	-	-	-	55	54	17.0	32.4	19.6	36.3	90	89 7/16	28.6	53.8	32.2	58.4	125	124 14/16	39.7	70.7	43.8	75.7
21	20 9/16	6.2	12.1	7.4	13.9	56	56	17.6	33.5	20.3	37.5	91	-	-	-	-	-	126	-	-	-	-	
22	-	-	-	-	-	57	-	-	-	-	-	92	91 7/16	29.2	54.8	32.9	59.5	127	126 14/16	40.3	71.7	44.4	76.1
23	22 8/16	6.7	13.3	8.2	15.2	58	57 15/16	18.2	34.7	21.0	38.7	93	-	-	-	-	-	128	-	-	-	-	
24	-	-	-	-	-	59	-	-	-	-	-	94	93 6/16	29.9	55.8	33.6	60.5	129	128 13/16	40.8	72.8	45.0	76.6
25	24 8/16	7.3	14.5	8.9	16.6	60	59 15/16	18.9	35.9	21.7	39.8	95	-	-	-	-	-	130	-	-	-	-	
26	-	-	-	-	-	61	-	-	-	-	-	96	95 6/16	30.2	56.3	34.0	61.1	131	130 13/16	41.4	73.8	45.6	77.0
27	26 7/16	8.0	15.7	9.6	18.0	62	61 14/16	19.5	37.1	22.4	41.1	97	-	-	-	-	-	132	-	-	-	-	
28	-	-	-	-	-	63	-	-	-	-	-	98	97 5/16	30.8	57.2	34.7	62.2	133	132 12/16	41.9	74.8	46.3	77.4
29	28 7/16	8.6	17.0	10.4	19.4	64	63 14/16	20.2	38.4	23.2	42.4	99	-	-	-	-	-	134	-	-	-	-	
30	-	-	-	-	-	65	-	-	-	-	-	100	99 5/16	31.3	57.9	35.4	63.4	135	134 12/16	42.5	75.5	46.8	78.1
31	30 6/16	9.3	18.2	11.1	20.7	66	65 13/16	20.8	39.7	24.0	43.7	101	-	-	-	-	-	136	-	-	-	-	
32	-	-	-	-	-	67	-	-	-	-	-	102	101 4/16	31.9	58.6	36.0	64.7	137	136 11/16	43.1	76.3	47.3	78.8
33	32 6/16	9.7	18.8	11.5	21.4	68	67 13/16	21.5	41.0	24.7	45.1	103	-	-	-	-	-	138	-	-	-	-	
34	-	-	-	-	-	69	-	-	-	-	-	104	103 4/16	32.4	59.3	36.7	65.9	139	138 11/16	43.7	77.0	47.8	79.6
35	34 5/16	10.3	20.0	12.2	22.8	70	69 12/16	22.1	42.3	25.5	46.4	105	-	-	-	-	-	140	-	-	-	-	
36	-	-	-	-	-	71	-	-	-	-	-	106	105 3/16	32.9	60.0	37.3	67.2	141	140 10/16	44.3	77.7	48.3	80.3
37	36 5/16	11.0	21.3	13.0	24.2	72	71 12/16	22.8	43.5	26.3	47.8	107	-	-	-	-	-	142	-	-	-	-	
38	-	-	-	-	-	73	-	-	-	-	-	108	107 3/16	33.5	60.7	38.0	68.4	143	142 10/16	44.9	78.5	48.8	81.0
39	38 4/16	11.7	22.5	13.7	25.6	74	73 11/16	23.5	44.8	26.9	49.0	109	-	-	-	-	-	144	-	-	-	-	
40	-	-	-	-	-	75	-	-	-	-	-	110	109 2/16	34.0	61.4	38.6	69.7						
41	40 4/16	12.4	23.8	14.5	27.0	76	75 11/16	24.1	46.0	27.6	50.2	111	-	-	-	-	-						
42	-	-	-	-	-	77	-	-	-	-	-	112	111 2/16	34.8	62.6	39.3	70.5						
43	42 3/16	13.1	25.0	15.2	28.5	78	77 10/16	24.8	47.2	28.2	51.4	113	-	-	-	-	-						
44	-	-	-	-	-	79	-	-	-	-	-	114	113 1/16	35.6	63.8	39.9	71.4						
45	44 3/16	13.8	26.3	16.0	29.9	80	79 10/16	25.4	48.4	28.8	52.6	115	-	-	-	-	-						
46	-	-	-	-	-	81	-	-	-	-	-	116	115 1/16	36.3	65.0	40.6	72.3						

**Power Consumption**

Tested at Full Power with PDC Series power supplies.

\*For Back Feed add 4/16" (1/4") to Actual Length. Standard Nominal Lengths offered provide minimal shadowing. For alternate lengths, please consult Inside Sales with specific request.

**PIXEL (RGBX18/RGBWX18)**

Nominal Length (in)	End Feed Actual Length*	Watts		Nominal Length (in)	End Feed Actual Length*	Watts		Nominal Length (in)	End Feed Actual Length*	Watts		Nominal Length (in)	End Feed Actual Length*	Watts	
		RGBX18	RGBWX18			RGBX18	RGBWX18			RGBX18	RGBWX18			RGBX18	RGBWX18
		SO	SO			SO	SO			SO	SO			SO	SO
12	8 12/16	4.6	5.7	47	-	-	-	82	-	-	-	117	-	-	-
13	12 11/16	4.6	5.7	48	-	-	-	83	-	-	-	118	-	-	-
14	-	-	-	49	48 2/16	17.4	21.9	84	83 9/16	29.8	37.1	119	119	40.9	51.2
15	-	-	-	50	-	-	-	85	-	-	-	120	-	-	-
16	-	-	-	51	-	-	-	86	-	-	-	121	-	-	-
17	16 10/16	6.1	7.5	52	-	-	-	87	-	-	-	122	-	-	-
18	-	-	-	53	52 1/16	18.9	23.7	88	87 8/16	31.1	38.7	123	122 15/16	42.1	52.8
19	-	-	-	54	-	-	-	89	-	-	-	124	-	-	-
20	-	-	-	55	-	-	-	90	-	-	-	125	-	-	-
21	20 9/16	7.6	9.4	56	56	20.3	25.4	91	-	-	-	126	-	-	-
22	-	-	-	57	-	-	-	92	91 7/16	32.4	40.3	127	126 14/16	43.3	54.3
23	-	-	-	58	-	-	-	93	-	-	-	128	-	-	-
24	-	-	-	59	-	-	-	94	-	-	-	129	-	-	-
25	24 8/16	9.1	11.3	60	59 15/16	21.7	27.1	95	-	-	-	130	-	-	-
26	-	-	-	61	-	-	-	96	95 6/16	33.4	41.6	131	130 13/16	44.5	55.9
27	-	-	-	62	-	-	-	97	-	-	-	132	-	-	-
28	-	-	-	63	-	-	-	98	-	-	-	133	-	-	-
29	28 7/16	10.6	13.2	64	63 14/16	23.0	28.8	99	-	-	-	134	-	-	-
30	-	-	-	65	-	-	-	100	99 5/16	34.6	43.2	135	134 12/16	45.7	57.4
31	-	-	-	66	-	-	-	101	-	-	-	136	-	-	-
32	-	-	-	67	-	-	-	102	-	-	-	137	-	-	-
33	32 6/16	11.7	14.6	68	67 13/16	24.4	30.5	103	-	-	-	138	-	-	-
34	-	-	-	69	-	-	-	104	103 4/16	35.9	44.8	139	138 11/16	46.9	58.9
35	-	-	-	70	-	-	-	105	-	-	-	140	-	-	-
36	-	-	-	71	-	-	-	106	-	-	-	141	-	-	-
37	36 5/16	13.1	16.5	72	71 12/16	25.8	32.3	107	-	-	-	142	-	-	-
38	-	-	-	73	-	-	-	108	107 3/16	37.2	46.4	143	142 10/16	48.0	60.4
39	-	-	-	74	-	-	-	109	-	-	-	144	-	-	-
40	-	-	-	75	-	-	-	110	-	-	-	-	-	-	-
41	40 4/16	14.6	18.3	76	75 11/16	27.1	33.9	111	-	-	-	-	-	-	-
42	-	-	-	77	-	-	-	112	111 2/16	38.4	48.0	-	-	-	-
43	-	-	-	78	-	-	-	113	-	-	-	-	-	-	-
44	-	-	-	79	-	-	-	114	-	-	-	-	-	-	-
45	44 3/16	16.0	20.1	80	79 10/16	28.4	35.5	115	-	-	-	-	-	-	-
46	-	-	-	81	-	-	-	116	115 1/16	39.7	49.6	-	-	-	-



### Voltage Drop Calculator

The below chart assumes nominal voltage of 24 Volts and a Voltage Drop Allowance of 3% through the wire

Wattage [W]	Maximum Wire Length From Power Supply to Start of Run [ft]						
	12 AWG	14 AWG	16 AWG	18 AWG	20 AWG	22 AWG	24 AWG
5	1088.2	684.4	430.3	270.6	170.2	107.1	67.3
10	544.1	342.2	215.1	135.3	85.1	53.5	33.7
15	362.7	228.1	143.4	90.2	56.7	35.7	22.4
20	272.0	171.1	107.6	67.7	42.6	26.8	16.8
25	217.6	136.9	86.1	54.1	34.0	21.4	13.5
30	181.4	114.1	71.7	45.1	28.4	17.8	11.2
35	155.5	97.8	61.5	38.7	24.3	15.3	9.6
40	136.0	85.5	53.8	33.8	21.3	13.4	8.4
45	120.9	76.0	47.8	30.1	18.9	11.9	7.5
50	108.8	68.4	43.0	27.1	17.0	10.7	6.7
55	98.9	62.2	39.1	24.6	15.5	9.7	6.1
60	90.7	57.0	35.9	22.6	14.2	8.9	5.6
65	83.7	52.6	33.1	20.8	13.1	8.2	5.2
70	77.7	48.9	30.7	19.3	12.2	7.6	4.8
75	72.5	45.6	28.7	18.0	11.3	7.1	4.5
80	68.0	42.8	26.9	16.9	10.6	6.7	4.2
85	64.0	40.3	25.3	15.9	10.0	6.3	4.0
90	60.5	38.0	23.9	15.0	9.5	5.9	3.7
96	56.7	35.6	22.4	14.1	8.9	5.6	3.5

### T-Grid Compatibility

Brand	Type	Part Number	Description
USG*	9/16	208257	DX/DXL-24 SUSPENSION FLAT WHITE
	15/16	215673	DONN AX SUSPENSION
	15/16	272638	DXCE FLAT WHITE
	15/16	207901	M7 OVERLAPPING
ARM-STRONG	9/16	BPGZ068	SURPRAFINE XL HRC
	15/16	BPGZ051	PRELUDE XL HRC EXPOSED TEE SYSTEM
	15/16	BPGZ044	PRELUDE ML EXPOSED TEE SYSTEM
	15/16	BPGZ046	PRELUDE XL FIRE EXPOSED TEE SYSTEM

\* Statement of Compatibility from USG:

Luminii's fixtures at 0.25lbs/ft can be fully supported by the USG grids listed in the table above and do not require any additional structural support or modifications to the grid system as long as the overall ceiling weight including specified fixtures and/or any other components supported by the grid does not cross the allowed ceiling weight per state building structural codes.

## Power Supplies

See fixture and power supply instructions & spec sheet for wiring information. Dimming possible in select models - view Luminii website for list of compatible dimmers.

### For use with Warm Dim, WD68

#### Triac, MLV, & ELV Compatible Dimmers

MODEL	POWER	OUTPUT
PDC - (IP20) Power Supply	96 - 96 Watts	24 - 24 VDC

MODELS	96W
<b>Length</b>	8.25"
<b>Width</b>	4.10"
<b>Depth</b>	1.56"

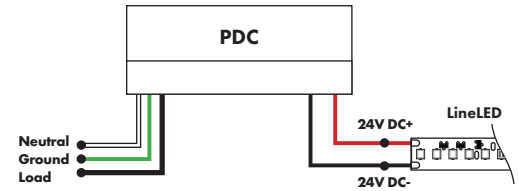

### For use with Dynamic White, DW68

#### 0-10V Warm Dimming 0% Power Supply 120VAC - 277VAC (for warm dimming of Dynamic White option)

MODEL	POWER	OUTPUT
PS010WD - 0-10 Warm dim LED Power Supply	96 - 96 Watt	24 - 24 VDC

Requires a 0-10V controller to work properly

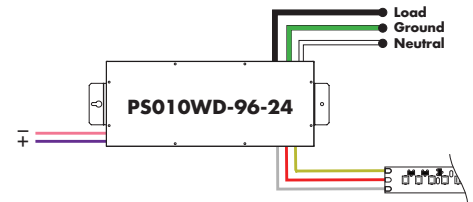

#### 0-10V Tunable White 0% Dimming Power Supply 120VAC - 277VAC (for tunable white control of Dynamic White option)

MODEL	POWER	OUTPUT
PS010TW - 0-10 Tunable White LED Driver	96 - 96 Watt	24 - 24 VDC

Requires two 0-10V controllers to work properly

MODELS	PS010TW
<b>A Length</b>	14.40"
<b>B Width</b>	2.60"
<b>C Depth</b>	5.20"

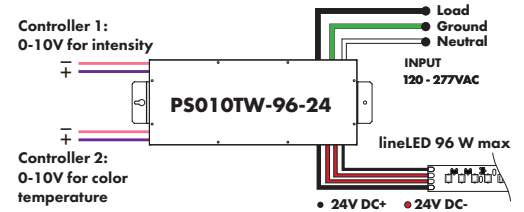

#### Customizable Dim to Warm or Variable White via 0 - 10V (for tunable white or warm dimming control of Dynamic option)

MODEL	POWER	OUTPUT	CONTROL
PS010V-0-10 LED Driver	96-96 Watt	24-24 VDC	WW- Standard One Channel - Dim To Warm Curve W2C- Standard Two Channel - Dim 1: Intensity; Dim 2: CCT W21- Standard Two Channel - Dim 1: Warm Channel Intensity; Dim 2: Cool Channel Intensity W1X- ___ Custom One Channel - Dim To Warm Curve W2X- ___ Custom two Channel - Dim 1: Intensity; Dim 2: CCT

Requires a 0-10V controller to work properly

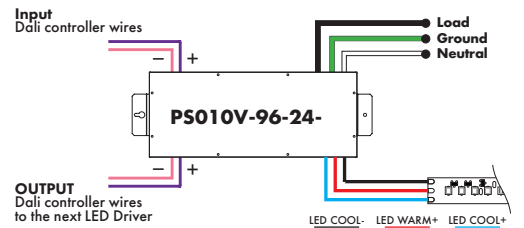

### For use with RGB/RGBW/Pixel, RGB42/RGBW36/RGBX18/RGBWX18

#### Non-Dimming Power Supply 120VAC - 277VAC

MODEL	POWER	OUTPUT	DIMMING	LOCATION
PSV - PSV Series	96 - 96 Watt	24 - 24 VDC	U2ND - Non Dimming	D - Dry location

Requires a controller and a decoder to work properly

MODELS	96W
<b>A Length</b>	14.40"
<b>B Width</b>	5.20"
<b>Depth</b>	2.60"

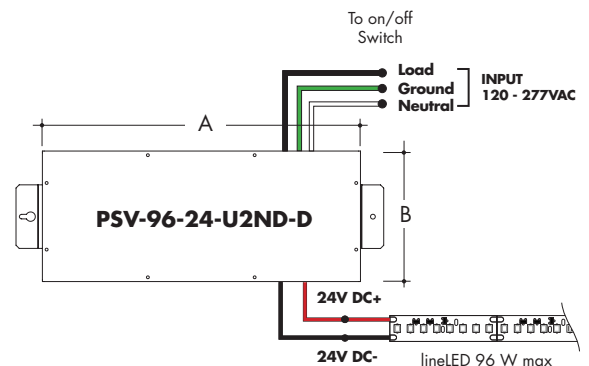

## Power Supplies

See fixture and power supply instructions & spec sheet for wiring information. Dimming possible in select models - view Luminii website for list of compatible dimmers.

### For use with RGB/RGBW, RGB42/RGBW36 or with Dynamic White, DW68

#### DMX 0% Dimming Power Supplies 120VAC - 277VAC

MODEL	POWER	OUTPUT
PSDMX-DMX Power Supply dims down to 0%	96 - 96 Watt 3X96 - 3 X 96 Watt	24-24 VDC

Features eldoLED's LINEARdrive configurable dimmable drivers.

DDMX-RGBW DMX Decoder not required when purchasing this power supply.

MODELS	96W	3X96
<b>A Length</b>	14.40"	15.75"
<b>B Width</b>	5.20"	6.62"
<b>Depth</b>	2.60"	4.95"

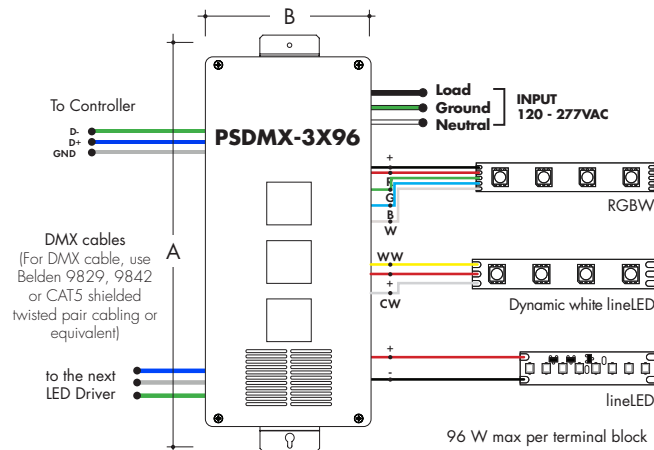
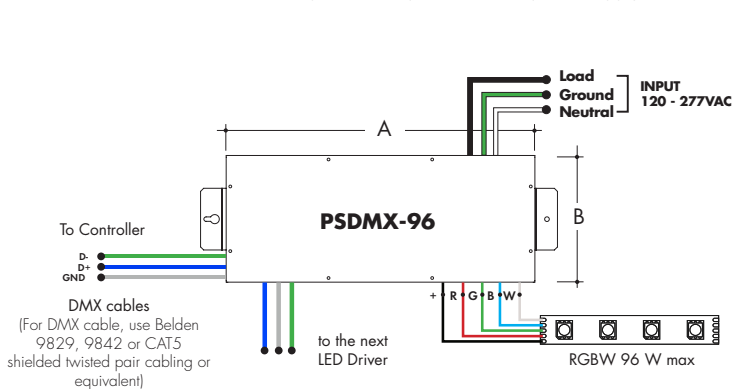

## DMX-1Z-RGBW, DMX-3Z-RGBW

RGBW LED 1 or 3 Zone Controller

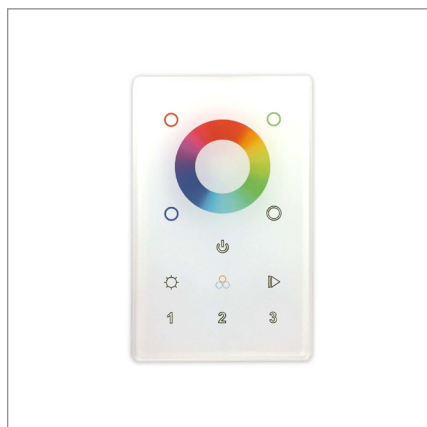

DMX /Wireless RGB-W wall-mount controller controls DMX lighting fixtures, wireless control of RGB-W lighting fixture or use both simultaneously. Fits in any standard US switch box. Includes all the outputs in the back of the controller.

Control brightness levels with a single touch, personalize and memorize 3 different scenes, and even create 3 variations of white.

#### Features

- 2 in 1 in-Wall Controller: DMX Control or Wireless RGB-W
- 65,000 Color Options, Dimming and Speed Control
- Memory Function
- 50 Foot Wireless Range
- Easily Fits Standard US Switch Boxes
- Touch Sensitive Glass Surface
- Includes 10 Built in Programs, or Create and Play Your Own

#### Operating Voltage

12 - 24V DC

#### Color Parameters

- Brightness
- Saturation
- Primary colors
- Fading
- Color changing speed

#### ORDERING CODE

MODEL	ZONES	COLOR
DMX - DMX Controller	3Z - Three Zone 1Z - One Zone	RGBW - Red, Green, Blue, & White

## Touch DMX Controller

Touchscreen digital LED controller

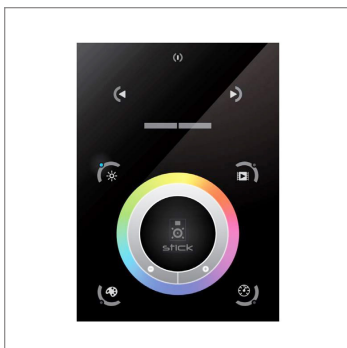

MODEL

**TSDMX-E**

TSDMX-E - Touchscreen DMX controller

Programmable advanced DMX512 lighting controller featuring a touch-screen interface. Operates as stand alone controller or integrated with most architectural lighting control systems. Can controller endless DMX512 enabled devices.

Mounts to standard single or dual gang wall box with the included power supply inside the junction box. Terminal block design for power and data connections.

### Features

- Sleek glass design which sits 0.43" from the wall
- Graphical color display to show selected environment
- Color/dimmer/speed palette
- Color temperature mixing
- Touch sensitive buttons. No mechanical parts
- Touch sensitive wheel allows for accurate color selection
- Multi-zone microSD memory
- Multi-room control with 500 scenes, 10 zones
- 1024 DMX channels. Control 340 RGB fixtures
- USB & Ethernet connectivity for programming and control

### Power Supply

7 VDC (included)

### Programmability

PC, Mac, Tablet, Smartphone

### Output Signal

DMX512 (1024 channels)

### Color Parameters

- Brightness
- Saturation
- Speed of color changing sequence
- Fading / dimming / brightness

## DMX Decoder

DMX signal to RGBW decoder (required to operate DMX controller)

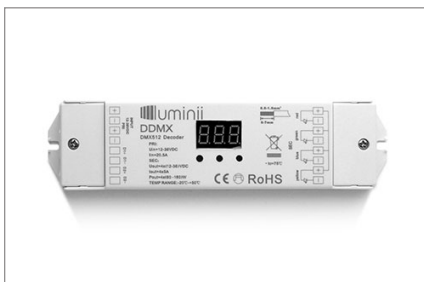

ORDERING CODE

MODEL

**DDMX-RGBW**

DDMX-RGBW - DMX decoder

Translates controller DMX512 programs for RGB and white LED strips.

Unique DMX address for the decoder can be set easily and displayed by the numeric display on the case. Changing and resetting the DMX address requires manual input.

Use power repeater to expand output.

### Operating Voltage

12-36 VDC

### Power Capacity

up to 96W at 24V

### Operating Temperature Range

from -4°F to +122°F in case

## Smart Pixel Decoder

SPI signal to DMX signal decoder



Model

**SR-DMX-SPI**

SR-DMX-SPI - Smart Pixel Decoder

The SR-DMX-SPI is a smart LED pixel decoder that controls RGB/RGBW pixel LED strips with SPI signal. Designed with an OLED backlit panel, the pixel controller allows for easy configuration of most settings. Four push buttons are available for control of the LED functions.

\*For pixel only.

### Features

- 2 in 1 in-Wall Controller: DMX Control or Wireless RGB-W
- SPI signal output for RGB/RGBW pixel light control
- DMX512 controllable and RF/WIFI remote controllable
- Capable of addressing up to 1020 RGB pixels & 765 RGB pixels
- OLED panel allows for easy configuration

### Operating Voltage

12 - 36V DC

### Power capacity

up to 96W at 24V

### Operating temperature range

from -4°F to +122°F in case