

VESTA 1 WM

WALL MOUNT



Vesta 1 WM - Wall mounted linear LED system. The Vesta1 WM luminaire offers a different application but all the benefits of its ceiling-mounted counterpart. A unique Senso design, the subtly flared Vesta 1 WM features a symmetrical, high-performance frosted lens, illuminating the lens surface evenly with no shadows or dark spots. With integrated drivers and controls, this fixture is easy to install and widely applicable. Vesta 1 WM offers both direct and indirect lighting options, allowing you to switch on the light sources independently or in unison.

Ordering Code



Product Specifications

SAMPLE : 353 - 90 - 6 - 40 - F0 - 02 - 06 - 04 - LUTES - 120 - 01

1 - Model	2 - CRI	3 - Length	4 - CCT	5 - Lens	6 - Finish	7 - Lumen
351 • Direct/Indirect 352 • Indirect 353 • Direct	90 • 90+	2 • 23" 4 • 45.5" 6 • 68" 8 • 90.5" 10 • 113" 12 • 135.5" A-T • More Lengths*1	27 • 2700K 30 • 3000K 35 • 3500K 40 • 4000K	<i>Down</i> F • Frosted Symmetric A • Asymmetric*2 0 • None <i>Up</i> F • Frosted Symmetric A • Asymmetric*2 0 • None	01 • White 02 • Black 08 • Silver XX • Custom	04 • 400 lm/ft (3.8 W) 06 • 566 lm/ft (5.7 W) 08 • 843 lm/ft (9.4 W) 10 • 1034 lm/ft (12 W) 12 • 1220 lm/ft (15 W)
8 - Indirect Lm	9 - Driver	Dim Level	Dim Level	10 - Voltage	11*8 - LED Control	
04 • 454 lm/ft (3.9 W) 06 • 628 lm/ft (5.6 W) 08 • 788 lm/ft (7.4 W) 00 • None	STD/LCS • 0 - 10 Volt dim option incl. ELDOLC • EldoLED 0 - 10 Volt DALI • Dali Protocol LUTES • Hilume Ecodigital LUT2W • 2 Wire for phase*3	1% 0.1% 0.1% 1% 1%	LUT5S • 5 Series Eco System DMX • Senso ODHS • Occupancy & Daylight Harvesting Sensor*4/5/6 CSMB • Casambi Wireless Control	120 • 120V 277 • 277V 347 • 347V*7	01 • Standard switching 02 • Separate switching 20 • Emergency wiring 21 • Emergency Battery Back-Up (4 foot section)	

*1 See page 3 for more detailed lengths

*2 Asymmetric Direct Lumen limited to **04/06/08** (wattages doubled)

*3 120V only

*4 Adds 3.75" to fixture length

*5 See Vesta Sensor spec sheet for additional information

*6 1 Sensor per 16" on model 352 and 353
1 Sensor per 8" on model 351

*7 Not available in Eldo, Lutron and DMX

*8 See page two for more details

Project : _____
 Quantity : _____
 Type : _____
 Notes : _____

VESTA 1 WM

WALL MOUNT

Light Engine

High Efficacy :	Up to 170 lumen/Watt
Color Options (CCT) :	2700K, 3000K, 3500K, 4000K, and Color Tuning
Color Consistency :	3-step MacAdam Ellipse
Color rendering (CRI) :	90+

Vesta 1 WM features a high-output, high-efficiency light engine—without any compromise. Class-leading efficiency at over 100lm/W keeps running costs low, while 50,000-hour (LM-80) lumen maintenance guarantees a sustainable design. Color rendering options are available up to 90+ CRI, along with color consistency within a three-step MacAdam ellipse. Every Vesta undergoes a multi-step test and burn-in procedure before shipping, ensuring the superior level of quality Senso is known for.

Dimming*5

Protocol:	0-10V DALI LUTRON DMX
------------------	--------------------------------

Level: From 0.1% to 10%

The Vesta combines high output with limitless possibilities of control. Dimming down to 0.1% is also available in Lutron (120-277V) and Dali systems (120-277V).

Switching

(For Direct / Indirect Configuration)

1. Standard switching
Single point feed required



2. Direct/indirect separate switching
Dual point feed required



*5 See page 1 for full dimming options

Installation

- Factory assembled for easy and fast installation
- Electrical wire and aircraft cable included
- Standard switch box needed (horizontal) for feed point
- Mounted bracket included

Construction

- Powder coated in white, black or silver
- Custom finish are available
- Housing: Aluminum extrusion
- Made in Canada

Dimensions

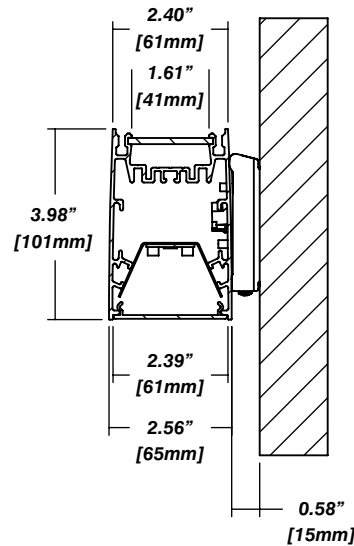

VESTA 1 WMM

WALL MOUNT



Standard Vesta Lengths

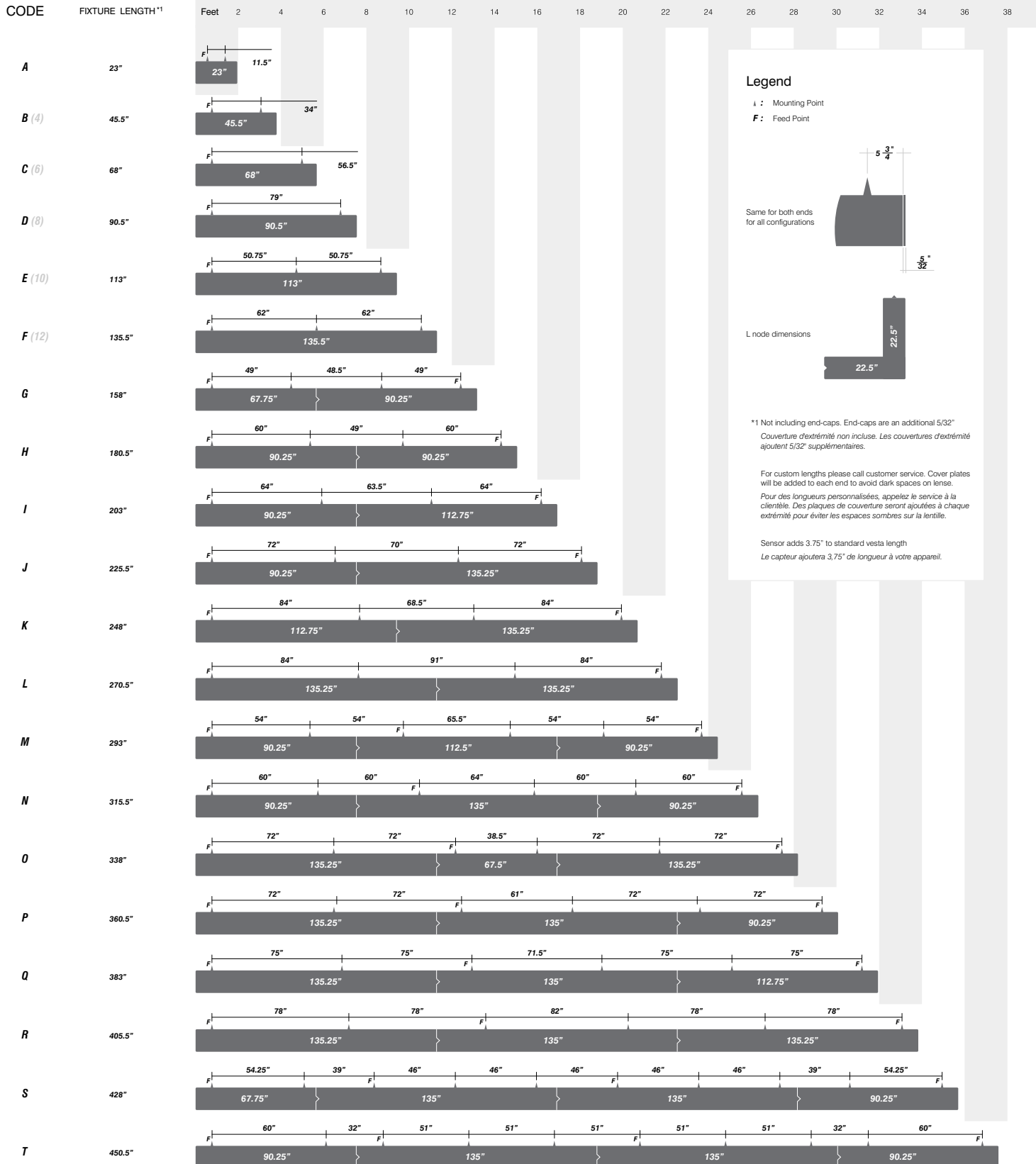

Legend

- M : Mounting Point
- F : Feed Point

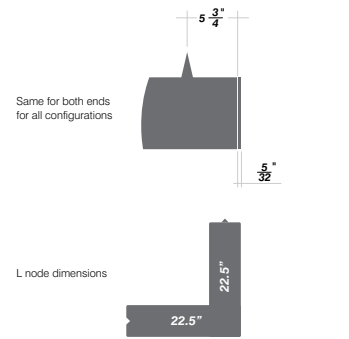

*1 Not including end-caps. End-caps are an additional 5/32" Couverture d'extrémité non incluse. Les couvertures d'extrémité ajoutent 5/32" supplémentaires.

For custom lengths please call customer service. Cover plates will be added to each end to avoid dark spaces on lense. Pour des longueurs personnalisées, appelez le service à la clientèle. Des plaques de couverture seront ajoutées à chaque extrémité pour éviter les espaces sombres sur la lentille.

Sensor adds 3.75" to standard vesta length Le capteur ajoutera 3,75" de longueur à votre appareil.

VESTA 1 WMM

WALL MOUNT



Photometrics

Senso's in-house photometric testing ensures that our lighting design can match your needs precisely. Our Goniophotometer and testing lab produces on-demand photometry files based on any specified fixture, including LM-79 Test reports, IES Files, and CRI/CCT measurements. See Sensolighting.com for more information.

*Full photometric Reports and IES files available for every configuration

Zonal Lumen Summary

Zone	Lumens	%Fixt
0-20	528.37	15.50
0-30	1085.53	31.90
0-40	1709.34	50.30
0-60	2806.23	82.60
0-80	3352.15	98.60
0-90	3398.12	100.00
10-90	3258.52	95.90
20-40	1180.97	34.70
20-50	1777.92	52.30
40-70	1453.16	42.80
60-80	545.92	16.10
70-80	189.65	5.60
80-90	45.97	1.40
90-110	0.56	0.00
90-120	0.57	0.00
90-130	0.57	0.00
90-150	0.57	0.00
90-180	0.57	0.00
110-180	0.01	0.00
0-180	3398.69	100.00

Luminance DATA (cd/sq.m)

Angle in °	Average 0°	Average 45°	Average 90°
45	1633	17494	18653
55	14387	15594	16807
65	12589	13662	14754
75	10484	11188	11811
85	7096	6899	6301

IES Indoor Report Coefficients of utilization - zonal cavity method

Effective Floor Cavity Reflectance 0.20

RC	80				70				50				30				10				0
RW	70	50	30	10	70	50	30	10	50	30	10	50	30	10	50	30	10	50	30	10	0
0	119	119	119	119	116	116	116	116	111	111	111	106	106	106	102	102	102	100	100	100	100
1	109	105	101	97	107	103	99	96	99	96	93	95	92	90	91	89	87	85	85	85	85
2	100	92	86	80	98	90	85	80	87	82	78	84	80	76	81	77	74	72	72	72	72
3	92	82	74	68	89	80	73	67	77	71	66	74	69	65	72	68	64	62	62	62	62
4	84	73	64	58	82	72	64	58	69	62	57	67	61	56	65	60	55	53	53	53	53
5	78	66	57	51	76	64	56	50	62	55	50	60	54	49	59	53	49	47	47	47	47
6	72	59	51	44	70	58	50	44	57	49	44	55	48	44	53	48	43	41	41	41	41
7	67	54	46	40	65	53	45	39	52	44	39	50	44	39	49	43	39	37	37	37	37
8	63	49	41	36	61	49	41	35	47	40	35	46	40	35	45	39	35	33	33	33	33
9	59	46	38	32	57	45	37	32	44	37	32	43	36	32	42	36	32	30	30	30	30
10	55	42	34	29	54	42	34	29	41	34	29	40	33	29	39	33	29	27	27	27	27

Vesta Light Distribution

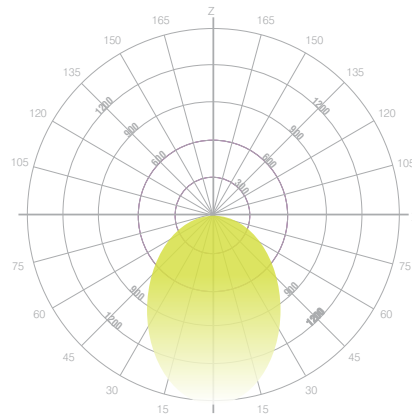

- Fixture: Vesta 48" [121.92 cm]
- Total Lumen Output: 3399 lm
- Wattage: 45 W
- Lumen per Watt: 75

Vesta Performance Example

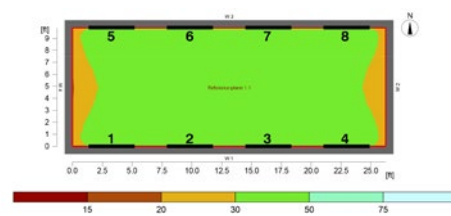

- Calculation algorithm used Average indirect fraction
- Height of luminaire plane 9.19' [0.00 m]
- Maintenance factor 31.5" [0.80 m]
- Total luminous flux of all lamps 27144 lm
- Total power 360.0 W
- Total power per area (28.00 m²) 9.64 W/m² (2.26 W/m²/100lx)

Color Metrics

TM 30-15

Our clients deserve the best information possible about their lighting choices. That's why Senso has invested in the Illuminating Engineering Society (IES) TM 30-15, a new system that measures an LED light source's color rendering properties. Using Senso's state-of-the-art goniophotometer, this method identifies the optimal light source for your project and helps evaluate the trade-offs between efficacy and color rendering. Senso can provide TM 30-15 data for all of our products.

*Full Color Metric Info Available at Sensolighting.com

VESTA 1 WMM

WALL MOUNT



Vesta 1 Downlight Distribution

Standard

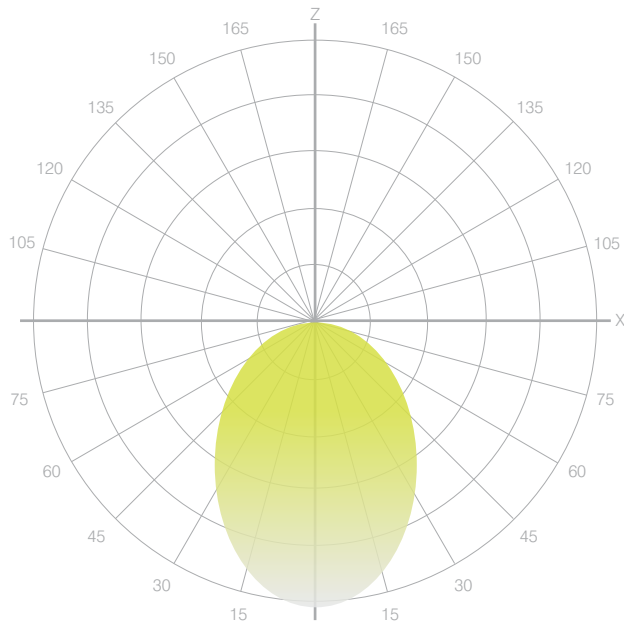

Asymetric

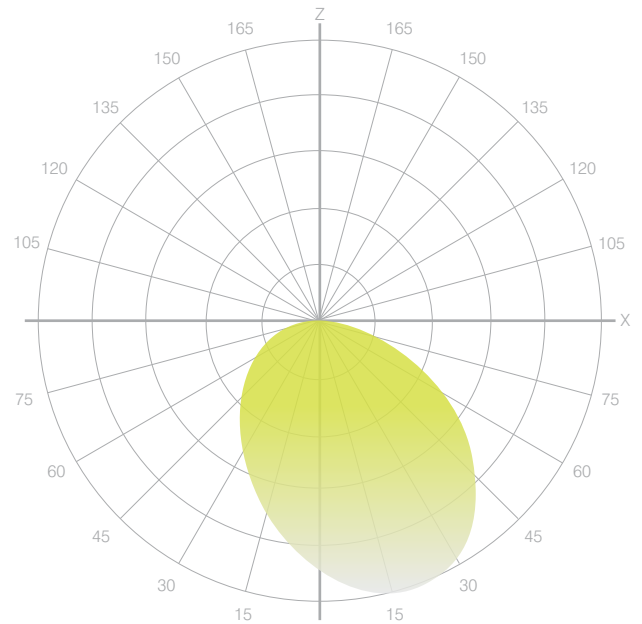

Vesta 1 Uplight Distribution

Standard

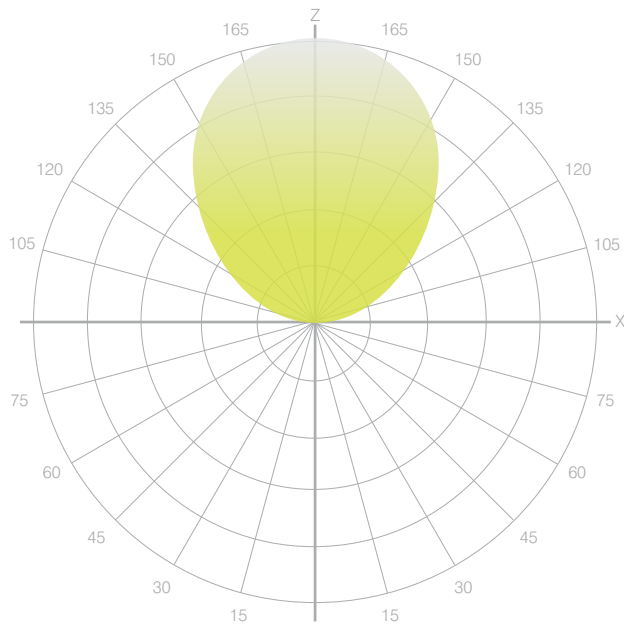

Batwing

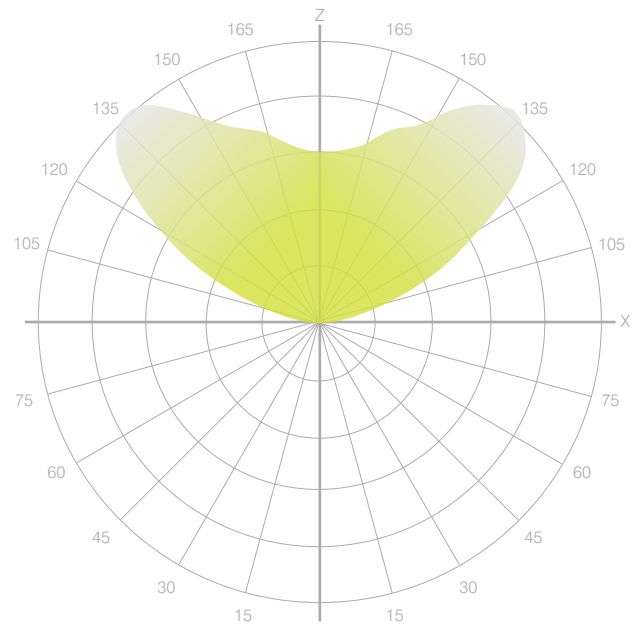

PROUD MEMBER OF



MADE IN CANADA