

Features

Kurba Large Vertical is a direct view, small profile, energy efficient and flexible LED strip suitable for wet locations capable of vertical/top bends up to 6" radius. Built with robust factory made power feeds or joiners, Kurba Vertical mounts to a specifically designed aluminum extruded channel.

Applications

Outdoor wet location

Operating Voltage

24VDC

Operating Temperature

-4°F to 113°F (-20°C to 45°C)

Average Life

50,000 hours

Dimming

Low voltage dimmer and class 2 dimming power supply required

Approvals

Class 2 wet listed, IP67

Warranty

3 years



Technical Information

Model	KBL-F-V	CCT INFO / LUMEN MULTIPLIER	
		Color Temperature	Multiplier (ref. -3000K)
LEDs/ft	32	2200K	0.98
Light Output at 3000K	178 lm/ft	2400K	1.00
Average Power Consumption at 4'	3.66 W/ft	2700K	1.01
Ordering Increment	2.19"	3000K	1.00
Maximum Run Length (In Series)	25'	3500K	1.08
		4000K	1.04

Constraints

Bend Direction

Bend LED in these positions only to avoid damage

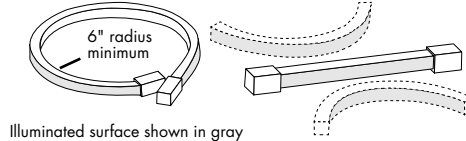

Illuminated surface shown in gray

Prohibited Bends

Twisting or bending LED in these positions will cause damage

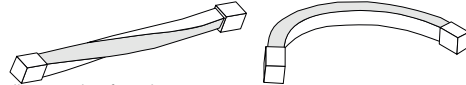

Illuminated surface shown in gray

Note: for horizontal bends refer to Luminii KBM series

Do not make sharp bends near the endcap

Power Feed Locations

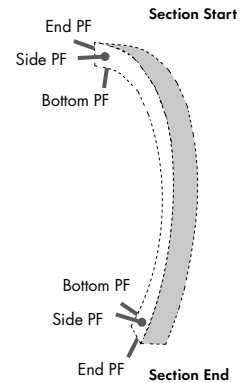

Section Start/End Power Feed Options

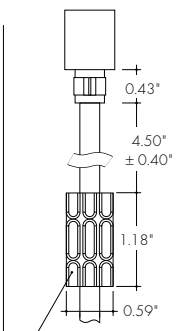
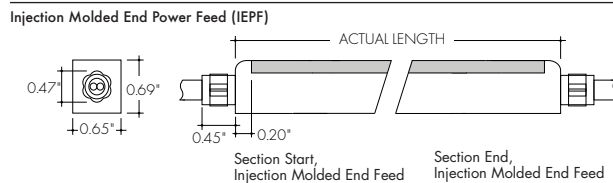
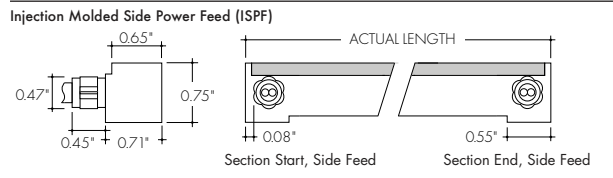
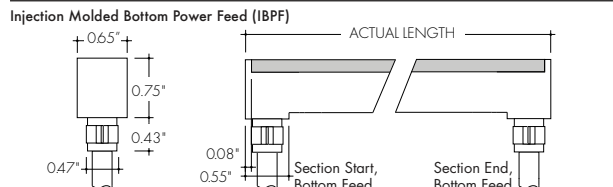
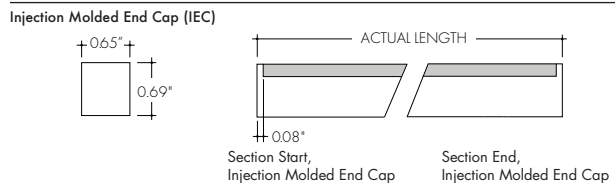
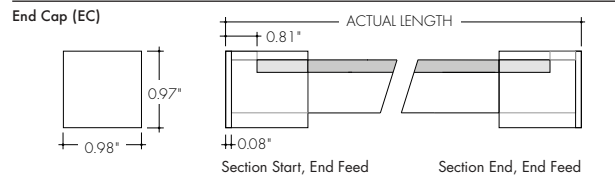
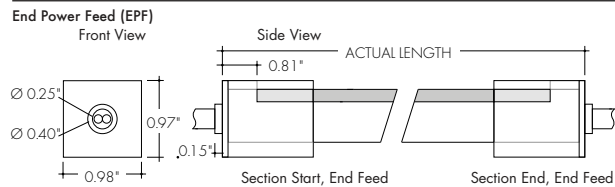

Anti-Wicking Ferrule
Included on every power feed wire. For protection against water ingress from inside of wire. IBPF shown for reference.

Ordering Code

MODEL	CCT	SECTION START	SECTION END	ACTUAL LENGTH
KBL-F-V-Kurba Large, flat vertical	22K-2200K 24K-2400K 27K-2700K 30K-3000K 35K-3500K 40K-4000K	EPF-End power feed (9' wire lead) EC-End cap IEPF-Injection Molded End power feed (9' wire lead) ¹ IBPF-Injection Molded Bottom power feed (9' wire lead) ¹ ISPF-Injection Molded Side power feed (9' wire lead) ^{1,2} IEC-Injection Molded End cap ¹	EPF-End power feed (9' wire lead) EC-End cap IEPF-Injection Molded End power feed (9' wire lead) ¹ IBPF-Injection Molded Bottom power feed (9' wire lead) ¹ ISPF-Injection Molded Side power feed (9' wire lead) ^{1,2} IEC-Injection Molded End cap ¹	See Power Consumption table on page 4 for available lengths

1 - 6-8 weeks lead time. Kurba injected-molded orders are non-cancellable. IEPF, IBPF, ISPF cannot be mixed and matched from Start to End except with IEC.

2 - ISPF Side power feeds selected for both Section Start and End will be located on the same side of the strip.

Mounting Accessories & Optional Connectors

MC-NFS-KBL-F-V-78
Mounting Channel with Grip, 78"

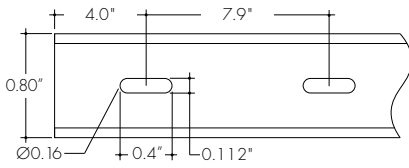
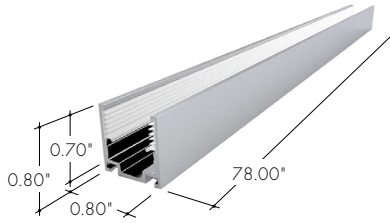

Aluminum mounting channel providing grip. For use with light strip mounted to the ceiling.

MB-KBL-F-V-ST
Mounting Bracket with Grip

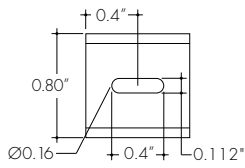
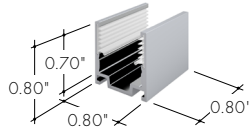

Aluminum mounting bracket providing grip. For use with light strip mounted to the ceiling. 1 recommended every 8 in.

MC-FS-KBL-F-V-78
Flanged Mounting Channel with grip, 78"

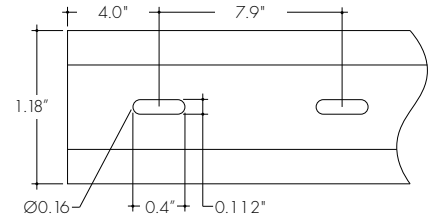
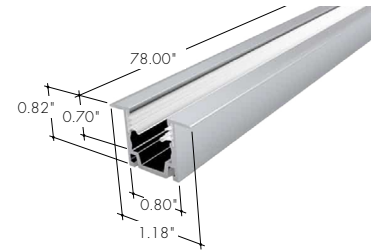

Flanged aluminum mounting channel providing grip. For use with light strip mounted to the ceiling.

MC-BNS-KBL-F-V-34
Bendable Mounting Channel with grip, 34"

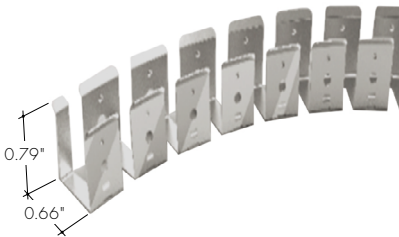

Bendable stainless steel mounting channel providing grip. For use with light strip mounted to the ceiling.

LVSP-WET-CM
Connector

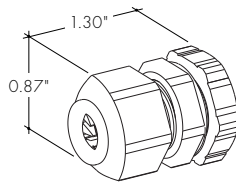

Low voltage splice box wet cable management, gray.

LVSP-WET
Splice Box

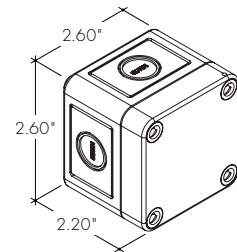

Wet rated, low voltage splice box, gray.

Power Supplies

See Power Supply instructions and spec sheet for wiring information. For a complete list of compatible dimmers, see Compatible Dimming Chart on the Resources page.

Universal Power Supply 1% 120VAC - 277VAC

MODEL	POWER	OUTPUT
PDCU-D - IP20 Dry Series	30 - 30 W 60 - 60 W 96 - 96 W 3X96 - 3X96 W	24 - 24 VDC
PDCU-W - IP66 Wet Series	96 - 96 W 3X96 - 3X96 W	

0-10V dims down to 1%, MLV/ELV/TRIAC dims down to 1%.
For a complete list of compatible dimmers, see [Compatible Dimming Chart](#) on the Resources page.

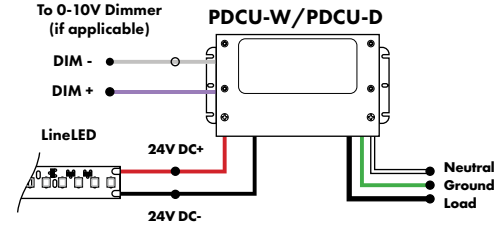

MODELS	PDCU-W 96W	PDCU-W 3X96W	PDCU-D 30W	PDCU-D 60W	PDCU-D 96W	PDCU-D 3X96W
Length	8.66"	11.85"	6.10"	7.93"	8.25"	9.57"
Width	3.73"	4.32"	3.35"	3.35"	4.10"	5.94"
Depth	1.61"	1.81"	1.33"	1.32"	1.56"	1.13"

0-10V Dimming Power Supplies 0.1% 120VAC - 277VAC

MODEL	POWER	OUTPUT	DIMMING
PS010V - 0-10V Power Supply dims down to 0.1%	96 - 96 Watt 3X96 - 3 X 96 Watt	24 - 24 VDC	LIN - Linear LOG - Logarithmic

MODELS	96W	3X96
Length	14.40"	15.75"
Width	5.20"	6.62"
Depth	2.60"	4.95"

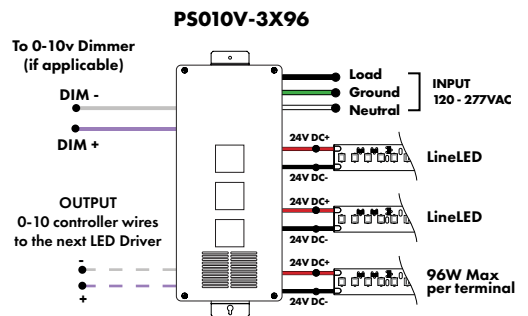
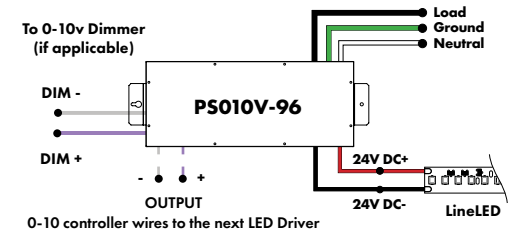

Triac, MLV, & ELV Compatible Dimmers

MODEL	POWER	OUTPUT
PDC - (IP20) Power Supply	96 - 96 Watts	24 - 24 VDC

MODELS	96W
Length	8.25"
Width	4.10"
Depth	1.56"

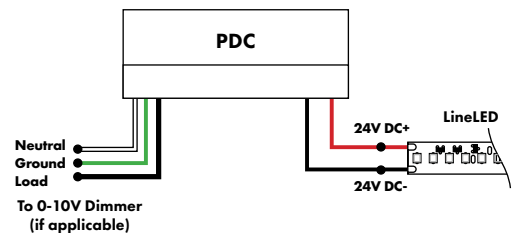

Power Supplies

See Power Supply instructions and spec sheet for wiring information. For a complete list of compatible dimmers, see Compatible Dimming Chart on the Resources page.

DMX Dimming Power Supplies 120VAC - 277VAC

MODEL	POWER	OUTPUT
PSDMX - DMX Power Supply dims down to 0%	96 - 96 Watt 3X96 - 3 X 96 Watt	24 - 24 VDC

Features eldoLED's LINEARdrive configurable dimmable drivers

MODELS	96W	3X96
Length	14.40"	15.75"
Width	5.20"	6.62"
Depth	2.60"	4.95"

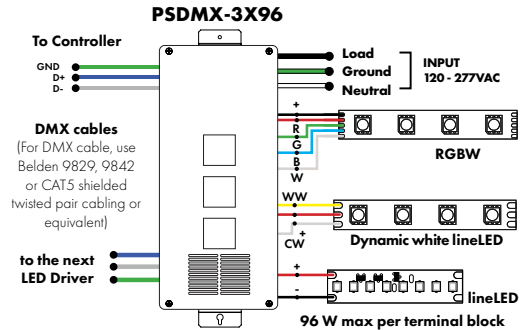
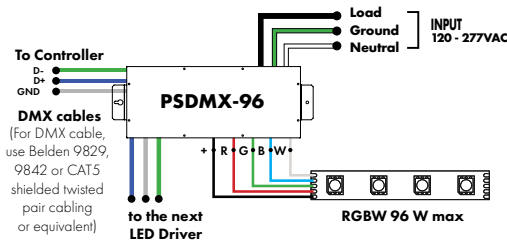

DALI 0% Dimming Power Supplies 120VAC - 277VAC

MODEL	POWER	OUTPUT
PSDALI - DALI Power Supply dims down to 0%	96 - 96 Watt 3X96 - 3 X 96 Watt	24 - 24 VDC

Features eldoLED's LINEARdrive configurable dimmable drivers

Model	96W	3X96
Length	14.40"	15.75"
Width	5.20"	6.62"
Depth	2.60"	4.95"

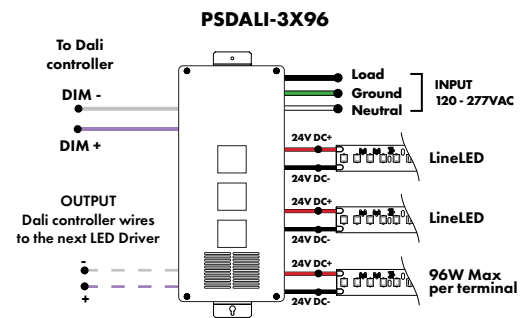
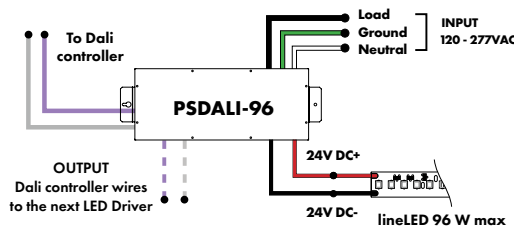

Enlighted Enabled Dimming Power Supplies 120VAC - 277VAC

MODEL	POWER	OUTPUT	DIMMING	LOCATION
PSV - PSV Series	96 - 96 Watt	24 - 24 VDC	ENL - Enlighted Dimming dims down to 0%	D - Damp

Model	96W
Length	14.40"
Width	5.20"
Depth	2.60"

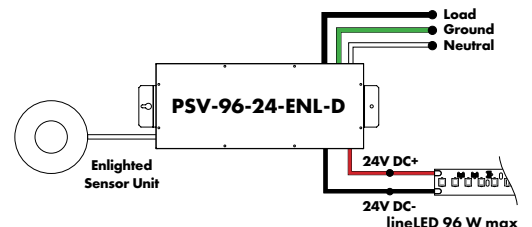

Power Supplies

See Power Supply instructions and spec sheet for wiring information. For a complete list of compatible dimmers, see Compatible Dimming Chart on the Resources page.

Non-Dimming Power Supply 120VAC - 277VAC

MODEL	POWER	OUTPUT	DIMMING	LOCATION
PSV - PSV Series	96 - 96 Watt	24 - 24 VDC	ND - Non Dimming	D - Damp

MODELS	96W
Length	14.40"
Width	5.20"
Depth	2.60"

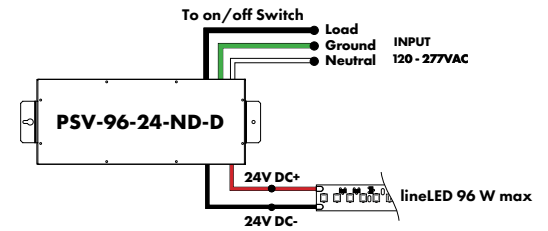

Luminii is a Lutron OEM Advantage Partner

Lutron Power Supplies 1%

MODEL
L3DA4U1UKL-CV240

HiLume™ 1% EcoSystem Voltage LED driver
40W max

MODELS	L3DA4U1UKL-CV240
Length	4.98"
Width	4.00"
Depth	2.62"

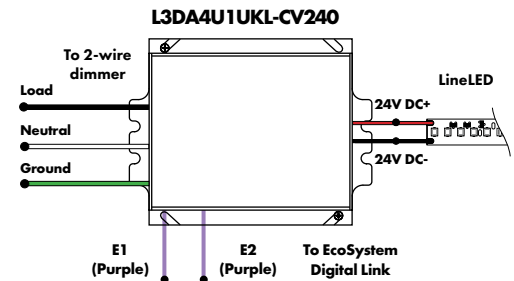

Luminii is a Lutron OEM Advantage Partner

Lutron Power Supplies 0.1%

MODEL
L3D0-96W24V-U

HiLume™ 0.1% EcoSystem Voltage LED Driver with Soft-On, Fade-to-Black™
96W max

MODELS	L3D0
Length	10.50"
Width	5.50"
Depth	2.00"

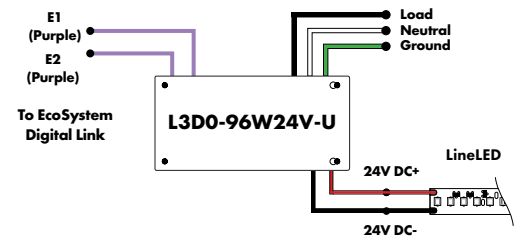

In-Ground Power Supplies

MODEL	POWER	OUTPUT	INPUT
IG - In ground CVE Series CVE - ELV Dimming DALI - eldoLED Dali dimming Both dims down to 0%	96X2 - 2 X 96 Watt	24 - 24 VDC	Blank - 120 V 277 - 240/277 V

MODELS	Dual Circuit
Length	8.40"
Width	8.30"
Depth	8.10"

