



Features

Kurba Large Vertical Sauna is a direct view, small profile, energy efficient and flexible LED strip. Suitable for Sauna and Spa locations and capable of vertical/top bends up to 6" radius. Built with robust factory made power feeds, Kurba Large Vertical Sauna mounts to a specifically designed channel.

Applications

Outdoor wet location

Operating Voltage

24VDC

Operating Temperature

Sauna: -40°F to 194°F (-40°C to 90°C),
100% relative humidity

Average Life

50,000 hours

Dimming

Low voltage dimmer and class 2 dimming power supply required

Approvals

Class 2 wet listed, IP67

Warranty

3 years



Technical Information

Model	KBL-SF-V-SN (Sauna)	CCT INFO / LUMEN MULTIPLIER	
		Color Temperature	Multiplier (ref. -3000K)
LEDs/ft	33	2200K	0.98
Light Output at 3000K	95 lm/ft	2400K	1.00
Average Power Consumption at 4'	1.8 W/ft	2700K	1.01
Ordering Increment	2.19"	3000K	1.00
Maximum Run Length (In Series)	30'	3500K	1.08
		4000K	1.04

Constraints

Bend Direction

Bend LED in these positions only to avoid damage

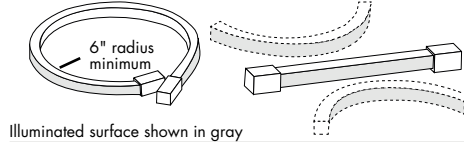

Illuminated surface shown in gray

Prohibited Bends

Twisting or bending LED in these positions will cause damage

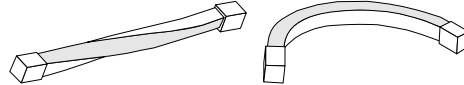

Illuminated surface shown in gray

Note: for horizontal bends refer to Luminii KBM series
Do not make sharp bends near the endcap

Power Feed Locations

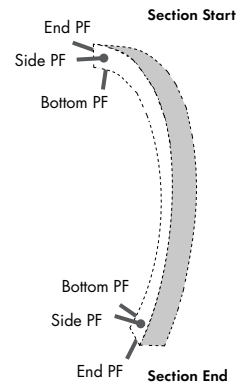

Section Start/End Power Feed Options

Injection Molded End Cap (IEC)

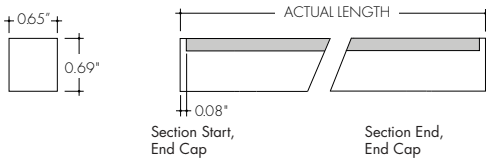

Injection Molded Bottom Power Feed (IBPF)

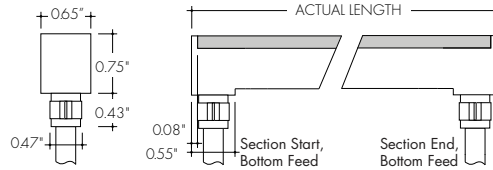

Injection Molded End Power Feed (IEPF)

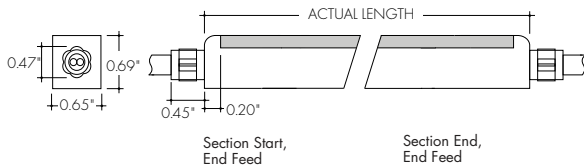

Injection Molded Side Power Feed (ISPF)

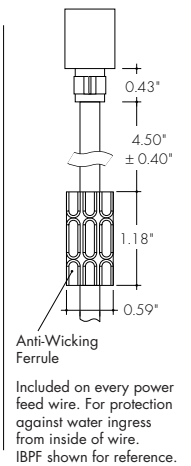
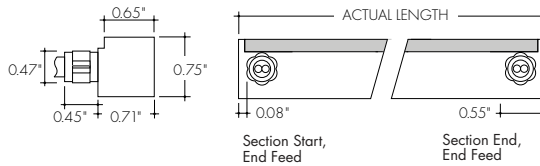

Ordering Code

MODEL	CCT	SECTION START	SECTION END	ACTUAL LENGTH
KBL-SF-VSN - Kurba Large, Flat, Vertical/Top Bend, Sauna Rated	22K - 2200K 24K - 2400K 27K - 2700K 30K - 3000K 35K - 3500K 40K - 4000K	IEPF - Injection Molded End power feed (9' wire lead) ¹ IBPF - Injection Molded Bottom power feed (9' wire lead) ¹ ISPF - Injection Molded Side power feed (9' wire lead) ^{1,2} IEC - Injection Molded End cap ¹	IEPF - Injection Molded End power feed (9' wire lead) ¹ IBPF - Injection Molded Bottom power feed (9' wire lead) ¹ ISPF - Injection Molded Side power feed (9' wire lead) ^{1,2} IEC - Injection Molded End cap ¹	See Power Consumption table on page 3 for available lengths

1 - 6-8 weeks lead time. Kurba injected-molded orders are non-cancellable. IEPF, IBPF, ISPF cannot be mixed and matched from Start to End except with IEC.
2 - ISPF Side power feeds selected for both Section Start and End will be located on the same side of the strip.

Mounting Accessories & Optional Connectors

MC-NFS-KBL-F-V-78

Mounting Channel with Grip, 78"

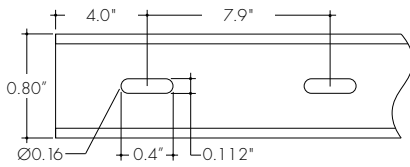
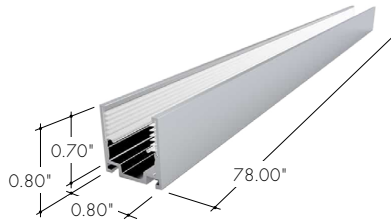

Aluminum mounting channel providing grip. For use with light strip mounted to the ceiling.

MB-KBL-F-V-ST

Mounting Bracket with Grip

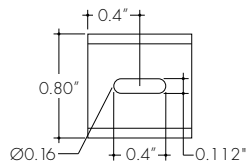
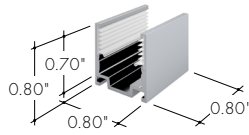

Aluminum mounting bracket providing grip. For use with light strip mounted to the ceiling. 1 recommended every 8 in.

MC-FS-KBL-F-V-78

Flanged Mounting Channel with grip, 78"

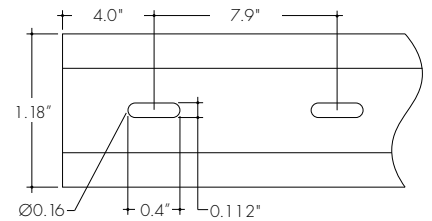
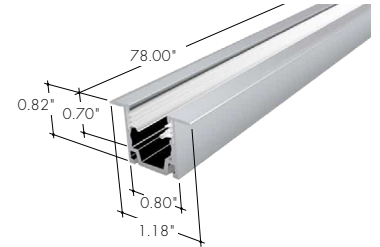

Flanged aluminum mounting channel providing grip. For use with light strip mounted to the ceiling.

MC-BNS-KBL-F-V-34

Bendable Mounting Channel with grip, 34"



Bendable stainless steel mounting channel providing grip. For use with light strip mounted to the ceiling.

LVSP-WET

Splice Box

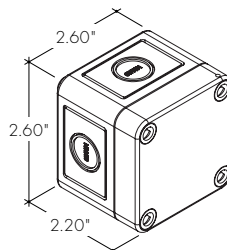

Wet rated, low voltage splice box, gray.

LVSP-WET-CM

Connector

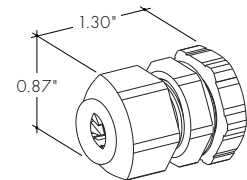

Low voltage splice box wet cable management, gray.

Power Consumption Per Fixture Length

Based on operation with PDCU series of power supplies. Use Actual Length for Order Code Entry
 Tolerance for Actual Lengths less than 6 ft is +/- 0.2", Actual Lengths between 6 ft and 16 ft is +/- 0.3", and Actual Lengths greater than 16 ft is +/- 0.6"

KBL-NF-V

Nominal Length (in)	Actual Length (in)				Nominal Length (in)	Actual Length (in)				Nominal Length (in)	Actual Length (in)			
	W	IEPF IEPF	IEC IEPF	IEC IBPF ISPF		W	IEPF IEPF	IEC IEPF	IEC IBPF ISPF		W	IEPF IEPF	IEC IEPF	IEC IBPF ISPF
3	-	-	-	-	75	11.4	74.8	74.7	74.5	147	22.4	147	146.8	146.7
5	-	-	-	-	77	11.7	77	76.8	76.7	149	22.7	149.1	149	148.9
7	1.1	7	6.8	6.7	80	12.1	79.1	79	78.9	152	23.1	151.3	151.2	151.1
9	1.4	9.1	9	8.9	81	12.4	81.3	81.2	81.1	154	23.4	153.5	153.4	153.3
(1 ft) 11	1.7	11.3	11.2	11.1	(7 ft) 84	12.7	83.5	83.4	83.3	(13 ft) 156	23.7	155.7	155.6	155.5
14	2.1	13.5	13.4	13.3	86	13.1	85.7	85.6	85.5	158	24.1	157.9	157.8	157.7
16	2.4	15.7	15.6	15.5	88	13.4	87.9	87.8	87.7	160	24.4	160.1	160	159.8
18	2.7	17.9	17.8	17.7	90	13.7	90.1	90	89.8	162	24.7	162.3	162.1	162
20	3.1	20.1	20	19.8	92	14.1	92.3	92.2	92	165	25.1	164.5	164.3	164.2
22	3.4	22.3	22.2	22	95	14.4	94.5	94.3	94.2	167	25.4	166.6	166.5	166.4
(2 ft) 24	3.7	24.5	24.3	24.2	(8 ft) 97	14.7	96.6	96.5	96.4	(14 ft) 169	25.7	168.8	168.7	168.6
27	4.1	26.6	26.5	26.4	99	15.1	98.8	98.7	98.6	171	26.1	171	170.9	170.8
29	4.4	28.8	28.7	28.6	101	15.4	101	100.9	100.8	173	26.4	173.2	173.1	173
31	4.7	31	30.9	30.8	103	15.7	103.2	103.1	103	176	26.7	175.4	175.3	175.2
33	5.1	33.2	33.1	33	106	16.1	105.4	105.3	105.2	178	27.1	177.6	177.5	177.3
(3 ft) 35	5.4	35.4	35.3	35.2	(9 ft) 108	16.4	107.6	107.5	107.3	(15 ft) 180	27.4	179.8	179.6	179.5
38	5.7	37.6	37.5	37.3	110	16.7	109.8	109.7	109.5					
40	6.1	39.8	39.7	39.5	112	17.1	112	111.8	111.7					
42	6.4	42	41.8	41.7	114	17.4	114.1	114	113.9					
44	6.7	44.1	44	43.9	116	17.7	116.3	116.2	116.1					
46	7.1	46.3	46.2	46.1	119	18.1	118.5	118.4	118.3					
(4 ft) 49	7.4	48.5	48.4	48.3	(10 ft) 121	18.4	120.7	120.6	120.5					
51	7.7	50.7	50.6	50.5	123	18.7	122.9	122.8	122.7					
53	8.1	52.9	52.8	52.7	125	19.1	125.1	125	124.8					
55	8.4	55.1	55	54.8	127	19.4	127.3	127.1	127					
57	8.7	57.3	57.2	57	130	19.7	129.5	129.3	129.2					
(5 ft) 60	9.1	59.5	59.3	59.2	(11 ft) 132	20.1	131.6	131.5	131.4					
62	9.4	61.6	61.5	61.4	134	20.4	133.8	133.7	133.6					
64	9.7	63.8	63.7	63.6	136	20.7	136	135.9	135.8					
66	10.1	66	65.9	65.8	138	21.1	138.2	138.1	138					
68	10.4	68.2	68.1	68	141	21.4	140.4	140.3	140.2					
70	10.7	70.4	70.3	70.2	143	21.7	142.6	142.5	142.3					
(6 ft) 73	11.1	72.6	72.5	72.3	(12 ft) 145	22.1	144.8	144.6	144.5					

Note: all values are rounded to the nearest 0.1 inch

Injection Molded End Cap (IEC)

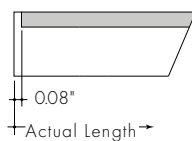

Injection Molded Bottom Power Feed (IBPF)

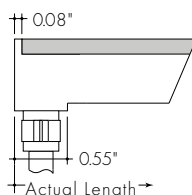

Injection Molded Side Power Feed (ISPF)

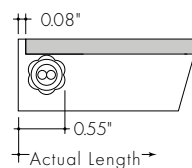

Injection Molded End Power Feed (IEPF)

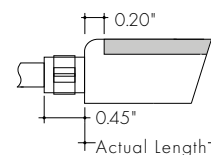

Power Consumption Per Fixture Length

Based on operation with PDCU series of power supplies. Use Actual Length for Order Code Entry
 Tolerance for Actual Lengths less than 6 ft is +/- 0.2", Actual Lengths between 6 ft and 16 ft is +/- 0.3", and Actual Lengths greater than 16 ft is +/- 0.6"

continued

Nominal Length (in)	Actual Length (in)					Actual Length (in)					Actual Length (in)				
	W	IEPF IEPF	IEC IEPF	IEC IBPF ISPF	Nominal Length (in)	W	IEPF IEPF	IEC IEPF	IEC IBPF ISPF	Nominal Length (in)	W	IEPF IEPF	IEC IEPF	IEC IBPF ISPF	
182	27.7	182	181.8	181.7	254	38.7	254.1	254	253.9	326.3	49.7	326.3	326.2	326.1	
184	28.1	184.1	184	183.9	257	39.1	256.3	256.2	256.1	328.5	50.1	328.5	328.4	328.3	
187	28.4	186.3	186.2	186.1	259	39.4	258.5	258.4	258.3	330.7	50.4	330.7	330.6	330.5	
189	28.7	188.5	188.4	188.3	261	39.7	260.7	260.6	260.5	332.9	50.7	332.9	332.8	332.6	
(16 ft) 191	29.1	190.7	190.6	190.5	(22 ft) 263	40.1	262.9	262.8	262.6	(28 ft) 335	51.1	335.1	335	334.8	
193	29.4	192.9	192.8	192.7	265	40.4	265.1	265	264.8	337.3	51.4	337.3	337.1	337	
195	29.7	195.1	195	194.8	268	40.7	267.3	267.1	267	339.4	51.7	339.4	339.3	339.2	
198	30.1	197.3	197.1	197	270	41.1	269.5	269.3	269.2	341.6	52.1	341.6	341.5	341.4	
200	30.4	199.5	199.3	199.2	272	41.4	271.6	271.5	271.4	343.8	52.4	343.8	343.7	343.6	
202	30.7	201.6	201.5	201.4	274	41.7	273.8	273.7	273.6	346	52.7	346	345.9	345.8	
(17 ft) 204	31.1	203.8	203.7	203.6	(23 ft) 276	42.1	276	275.9	275.8	(29 ft) 348	53.1	348.2	348.1	348	
206	31.4	206	205.9	205.8	279	42.4	278.2	278.1	278	350.4	53.4	350.4	350.3	350.1	
208	31.7	208.2	208.1	208	281	42.7	280.4	280.3	280.1	352.6	53.7	352.6	352.5	352.3	
211	32.1	210.4	210.3	210.2	283	43.1	282.6	282.5	282.3	354.8	54.1	354.8	354.6	354.5	
213	32.4	212.6	212.5	212.3	285	43.4	284.8	284.6	284.5	356.9	54.4	356.9	356.8	356.7	
(18 ft) 215	32.7	214.8	214.6	214.5	(24 ft) 287	43.7	286.9	286.8	286.7	(30 ft) 359	54.7	359.1	359	358.9	
217	33.1	217	216.8	216.7	289	44.1	289.1	289	288.9						
219	33.4	219.1	219	218.9	292	44.4	291.3	291.2	291.1						
222	33.7	221.3	221.2	221.1	294	44.7	293.5	293.4	293.3						
224	34.1	223.5	223.4	223.3	296	45.1	295.7	295.6	295.5						
226	34.4	225.7	225.6	225.5	298	45.4	297.9	297.8	297.6						
(19 ft) 228	34.7	227.9	227.8	227.6	(25 ft) 300	45.7	300.1	300	299.8						
230	35.1	230.1	230	229.8	302	46.1	302.3	302.1	302						
233	35.4	232.3	232.1	232	304	46.4	304.4	304.3	304.2						
235	35.7	234.5	234.3	234.2	307	46.7	306.6	306.5	306.4						
237	36.1	236.6	236.5	236.4	308.8	47.1	308.8	308.7	308.6						
(20 ft) 239	36.4	238.8	238.7	238.6	(26 ft) 311	47.4	311	310.9	310.8						
241	36.7	241	240.9	240.8	313.2	47.7	313.2	313.1	313						
243	37.1	243.2	243.1	243	315.4	48.1	315.4	315.3	315.1						
246	37.4	245.4	245.3	245.1	317.6	48.4	317.6	317.5	317.3						
248	37.7	247.6	247.5	247.3	319.8	48.7	319.8	319.6	319.5						
250	38.1	249.8	249.6	249.5	321.9	49.1	321.9	321.8	321.7						
(21 ft) 252	38.4	252	251.8	251.7	(27 ft) 324	49.4	324.1	324	323.9						

Note: all values are rounded to the nearest 0.1 inch

Injection Molded End Cap (IEC)

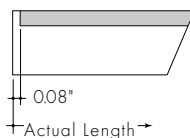

Injection Molded Bottom Power Feed (IBPF)

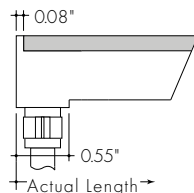

Injection Molded Side Power Feed (ISPF)

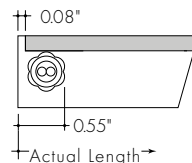

Injection Molded End Power Feed (IEPF)

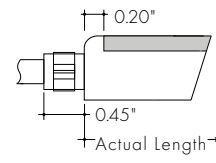

Power Supplies

See Power Supply instructions and spec sheet for wiring information. For a complete list of compatible dimmers, see Compatible Dimming Chart on the Resources page.

Universal Power Supply 1% 120VAC - 277VAC

MODEL	INPUT CONTROL	ENVIRONMENT	POWER	OUTPUT
PS - Pool & Spa Rated Power Supply	UNI - 0-10V, Phase Dimming	PR - Pool Rated	96 - 96 W	24 - 24 VDC

0-10V dims down to 1%, MLV/ELV/TRIAC dims down to 1%.
For a complete list of compatible dimmers, see [Compatible Dimming Chart](#) on the Resources page.

MODELS	PS-UNI-PR-96-24
Length	8.71"
Width	4.56"
Depth	1.86"

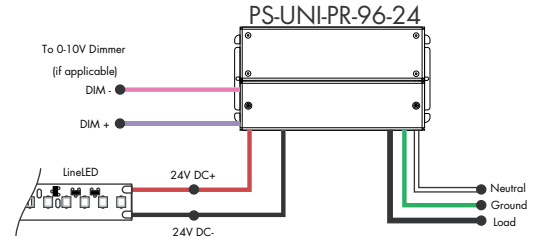

Universal Power Supply 1% 120VAC - 277VAC

MODEL	POWER	OUTPUT
PDCU-D - IP20 Dry Series	30 - 30 W 60 - 60 W 96 - 96 W 3X96 - 3X96 W	24 - 24 VDC
PDCU-W - IP66 Wet Series	96 - 96 W 3X96 - 3X96 W	

0-10V dims down to 1%, MLV/ELV/TRIAC dims down to 1%.
For a complete list of compatible dimmers, see [Compatible Dimming Chart](#) on the Resources page.

MODELS	PDCU-W 96W	PDCU-W 3X96W	PDCU-D 30W	PDCU-D 60W	PDCU-D 96W	PDCU-D 3X96W
Length	8.66"	11.85"	6.10"	7.93"	8.25"	9.57"
Width	3.73"	4.32"	3.35"	3.35"	4.10"	5.94"
Depth	1.61"	1.81"	1.33"	1.32"	1.56"	1.13"

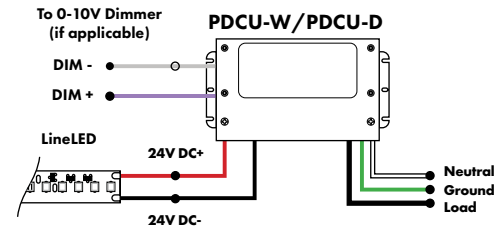

Enlighted Enabled Dimming Power Supplies 120VAC - 277VAC

MODEL	POWER	OUTPUT	DIMMING	LOCATION
PSV - PSV Series	96 - 96 Watt	24 - 24 VDC	ENL - Enlighted Dimming dims down to 0%	D - Damp

Model	96W
Length	14.40"
Width	5.20"
Depth	2.60"

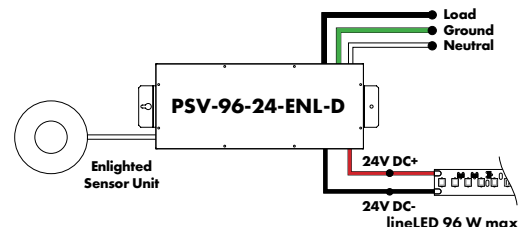

Triac, MLV, & ELV Compatible Dimmers

MODEL	POWER	OUTPUT
PDC - (IP20) Power Supply	96 - 96 Watts	24 - 24 VDC

MODELS	96W
Length	8.25"
Width	4.10"
Depth	1.56"

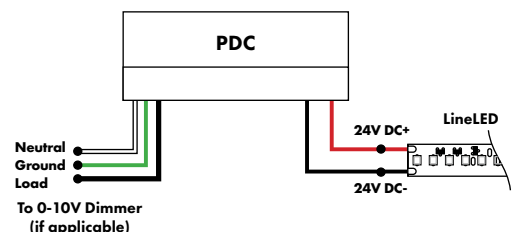

Power Supplies

See Power Supply instructions and spec sheet for wiring information. For a complete list of compatible dimmers, see Compatible Dimming Chart on the Resources page.

DMX Dimming Power Supplies 120VAC - 277VAC

MODEL	POWER	OUTPUT
PSDMX - DMX Power Supply dims down to 0%	96 - 96 Watt 3X96 - 3 X 96 Watt	24 - 24 VDC

Features eldoLED's LINEARdrive configurable dimmable drivers

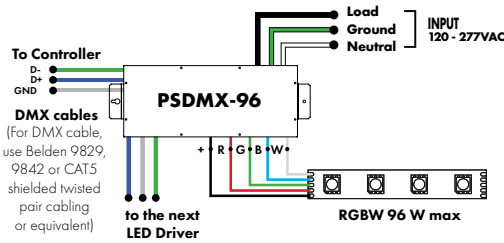

MODELS	96W	3X96
Length	14.40"	15.75"
Width	5.20"	6.62"
Depth	2.60"	4.95"

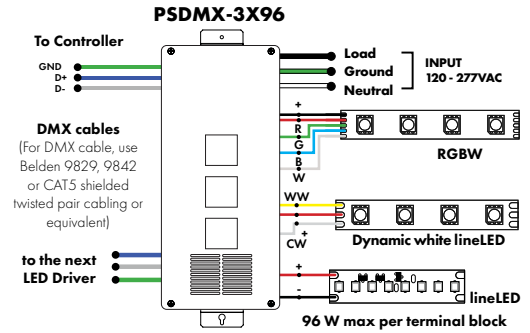

DALI 0% Dimming Power Supplies 120VAC - 277VAC

MODEL	POWER	OUTPUT
PSDALI - DALI Power Supply dims down to 0%	96 - 96 Watt 3X96 - 3 X 96 Watt	24 - 24 VDC

Features eldoLED's LINEARdrive configurable dimmable drivers

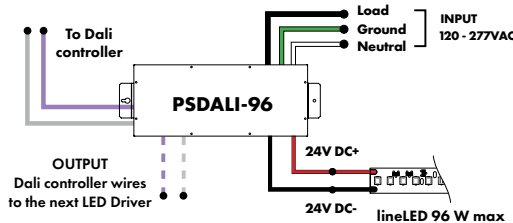

Model	96W	3X96
Length	14.40"	15.75"
Width	5.20"	6.62"
Depth	2.60"	4.95"

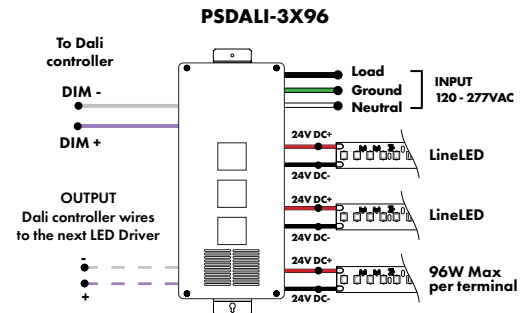

0-10V Dimming Power Supplies 0.1% 120VAC - 277VAC

MODEL	POWER	OUTPUT	DIMMING
PSO10V - 0-10V Power Supply dims down to 0.1%	96 - 96 Watt 3X96 - 3 X 96 Watt	24 - 24 VDC	LIN - Linear LOG - Logarithmic

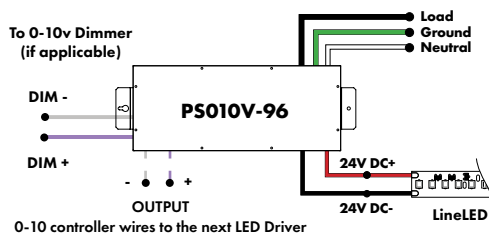

MODELS	96W	3X96
Length	14.40"	15.75"
Width	5.20"	6.62"
Depth	2.60"	4.95"

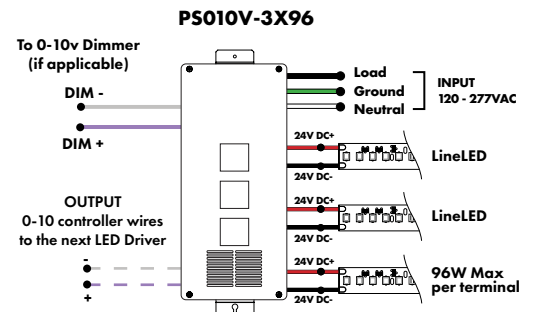

Power Supplies

See Power Supply instructions and spec sheet for wiring information. For a complete list of compatible dimmers, see Compatible Dimming Chart on the Resources page.

Non-Dimming Power Supply 120VAC - 277VAC

MODEL	POWER	OUTPUT	DIMMING	LOCATION
PSV - PSV Series	96 - 96 Watt	24 - 24 VDC	ND - Non Dimming	D - Damp

MODELS	96W
Length	14.40"
Width	5.20"
Depth	2.60"

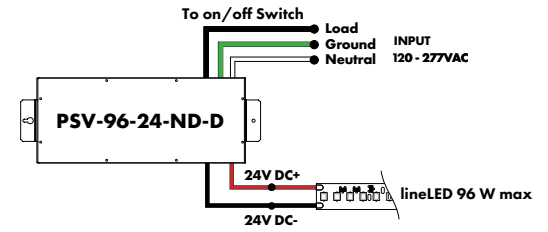

Luminii is a Lutron OEM Advantage Partner

Lutron Power Supplies 1%

MODEL
L3DA4U1UKL-CV240

HiLume™ 1% EcoSystem Voltage LED driver
40W max

MODELS	L3DA4U1UKL-CV240
Length	4.98"
Width	4.00"
Depth	2.62"

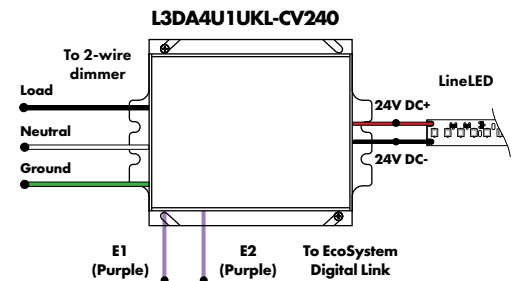

Luminii is a Lutron OEM Advantage Partner

Lutron Power Supplies 0.1%

MODEL
L3D0-96W24V-U

HiLume™ 0.1% EcoSystem Voltage LED Driver with Soft-On, Fade-to-Black™
96W max

MODELS	L3D0
Length	10.50"
Width	5.50"
Depth	2.00"

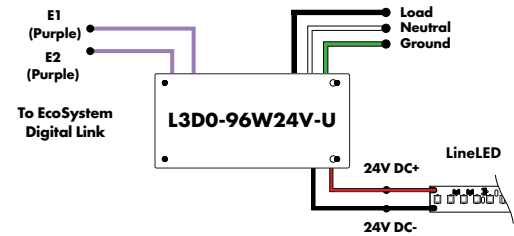

In-Ground Power Supplies

MODEL	POWER	OUTPUT	INPUT
IG - In ground CVE Series CVE - ELV Dimming DALI - eldoLED Dali dimming Both dims down to 0%	96X2 - 2 X 96 Watt	24 - 24 VDC	Blank - 120 V 277 - 240/277 V

MODELS	Dual Circuit
Length	8.40"
Width	8.30"
Depth	8.10"

