



**Features**

Basics Contractor-Grade small extrusions compatible with Basics LED strips.

**Finish**  
Silver anodized

**Mounting**  
Multiple mounting clip options ordered separately

**Diffuser Lens**  
Acrylic, snap-in-place, UV resistant

**Product Dimensions**

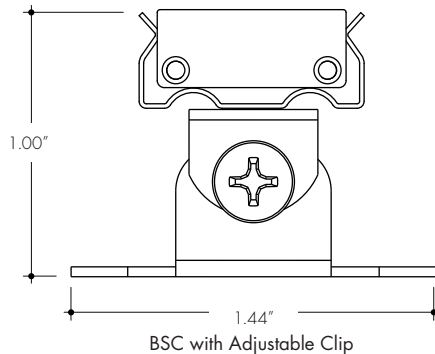
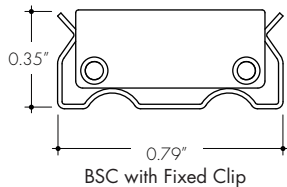
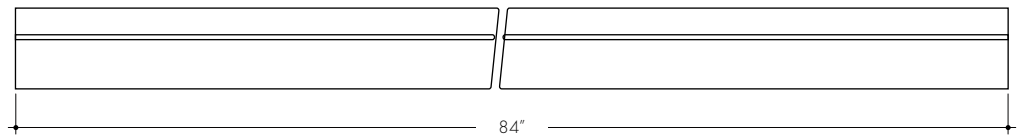
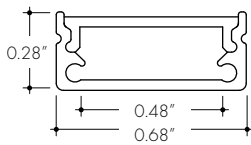

**INCLUDED MOUNTING ACCESSORIES**

EXTRUSION LENGTH	MOUNTING HARDWARE	END CAP (PAIR)
84"	4	1

Each pair of endcaps includes 1x H0 (no wire feed hole) and 1x H1 (with hole) where applicable. Additional endcaps and mounting clips are available for purchase.

**Accessories**

All Channels come with a specified set of Mounting Clips and End Caps, see Ordering Code for details. Order additional Mounting Clips and End Caps as necessary.

**EC-BSC-H0-SA**  
Silver Anodized End Cap

**EC-BSC-H1-SA**  
Silver Anodized End Cap with powerfeed opening

**MB-BMSC-SS**  
Fixed Clip  
**-FC**

**MB-BMSC-A-SS**  
Adjustable Clip  
**-A**

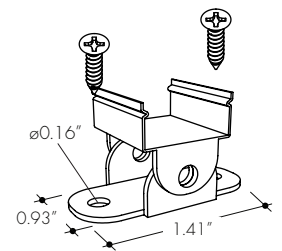
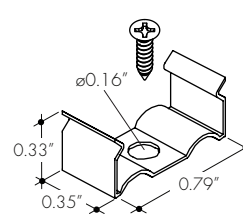
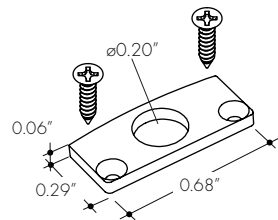
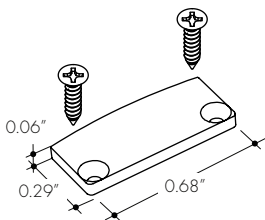

**Ordering code**

MODEL	LENGTH	LENS	MOUNTING <sup>2</sup>	FINISH
BSC · Basics Small Channel <sup>1</sup>	84 - 84"	C - Clear HF - Half Frosted F - Frosted	FC - Fixed Clip A - Adjustable	SA - Silver Anodized

1 - End Caps are included with channel, one of H0 (no hole) and one of H1 (with hole). Order additional End Caps as necessary.

2 - Mounting Clips are included with channel. Refer to chart above for provided mounting clip quantities. Order additional Mounting Clips as necessary.